

# INSTRUCTION & REFERENCE MANUAL

***Easy-Fire***



# IMPORTANT CAUTIONS

## **INSTALLATION CAUTIONS**

### **AMBIENT TEMPERATURES**

Operate in an environment between 0°C and 38°C (32 - 100°F).

### **CLEARANCES**

Install kiln a minimum of 30 cm (12") away from any wall, although a minimum of 45 cm (18") is preferable. Maintain a minimum of 90 cm (36") between two adjacent kilns especially if they are going to be used at the same time.

### **YOU MUST USE THE SUPPLIED KILN STAND**

Never set a kiln on a floor without significant air space circulating under the kiln. This is part of the insulation system of the kiln. Level the stand while installing.

### **WALL AND FLOOR MATERIALS**

Walls and floors must be non-combustible. Recommended floor surfaces are cement, ceramic tile, stone, slate, breeze blocks or brick. Do not install on a wood floor or on carpet. Vinyl flooring may also be combustible. Protect linoleum flooring from discoloration with a non-combustible covering. Remember that the kiln radiates heat over a long period of time and that this could start a fire under certain conditions. The continued heat of the kiln can dry out combustible surfaces over time and lower the temperature at which they could start burning. Temperatures at combustible ceilings and floors should be kept below 70°C (160°F). Check temperatures around the kiln while firing.

### **REQUIRED VENTILATION FOR THE KILN**

It is important to vent the room that the kiln is operating in. Kilns generate harmful fumes and heat when firing ceramics. Fumes can include carbon monoxide, formaldehyde, sulphur dioxide, heavy metal vapours, and fluorides (all of which can be very toxic). Install kiln in a well-ventilated area. Never operate in an enclosed space (such as a closet) without proper ventilation. The heat in an enclosed room could present a significant fire hazard. Severe corrosion can be caused by kiln fumes, salt air or other environmental conditions. Ventilation must be to the outside (and not under a window).

### **USE COPPER WIRE FOR HOOK UP**

Do not use aluminum wire.

### **PROTECT POWER LEAD FROM KILN CASE**

Route Power Lead away from kiln in such a way that it cannot touch the hot case of the kiln. Secure wires so they cannot move.

### **KEEP KILN DRY & IN PROTECTED SPACE**

The kiln must be kept dry. Water in contact with a kiln can cause an electrocution hazard.

# **EASY-FIRE KILN INSTRUCTIONS (EUROPEAN VERSION) WITH DYNATROL 700**

## **FIRE EXTINGUISHER**

Keep an adequate fire extinguisher (rated for electrical fires) near the kiln and check it yearly or according to local codes

## **GENERAL ENVIRONMENT CAUTIONS**

### **SURFACE IS HOT AND CAN CAUSE BURNS**

Kiln surface can be extremely hot (up to 260°C/ 500°F) and can cause severe burns if touched.

### **KEEP CHILDREN & ANIMALS AWAY FROM KILN**

Protect children, animals, and unqualified adults from the kiln.

### **KEEP FLAMMABLES AWAY FROM KILN**

Avoid flammable or loose clothing around kiln.

## **PRE-FIRING CAUTIONS**

### **PROPER USE OF KILN WASH**

Make sure the floor of the kiln and the tops of the shelves are coated with kiln wash. This will protect these surfaces from melting glaze and ceramics. Do not coat the undersides or sides of the shelves. Do not apply kiln wash to the brick sides or element holders.

### **DO NOT USE SILICA SAND IN KILN**

Silica can damage the kiln elements.

### **NEVER FIRE MOIST GREENWARE**

We recommend using Preheat in your bisque programme to help dry out any moisture that you cannot see.

## **LOADING & UNLOADING CAUTIONS**

### **TURN OFF KILN FROM DISCONNECT SWITCH WHEN NOT IN USE**

### **KEEP LID CLOSED WHEN KILN IS NOT IN USE**

Do not store anything on the closed lid or in the kiln.

## **EASY-FIRE KILN INSTRUCTIONS (EUROPEAN VERSION) WITH DYNATROL 700**

**DO NOT OPEN THE LID WHEN KILN IS ABOVE 120°C (250°F)**

### **FIRING CAUTIONS**

**DON'T FIRE KILN ABOVE Cone 10 (1290°C, 2350°F)**

#### **ATTEND THE FIRING**

No automatic safety device is foolproof! Be especially careful about attending the kiln while it is supposed to shut off. You can plan your firing using the Delay feature. If you can not be at the kiln all the time be sure to attend the end of the firing.

#### **USE PROGRAMME REVIEW**

Review the current programme prior to starting the kiln to ensure the correct profile is programmed. This is done by pressing the **Review Prog** button.

#### **USE THE PROPER THERMOCOUPLE (TYPE K)**

Never use a different type of thermocouple with your controller unless it has been set up from the factory. Use of a type S thermocouple will over fire your kiln. The standard thermocouples that come with the Easy-Fire kilns are type K.

#### **USE WITH THE THERMOCOUPLE PROTECTION TUBE**

Note that the control has been programmed with a 10°C thermocouple offset to compensate for the effect of the ceramic thermocouple protection tube. If for some reason you were to use the kiln without that protection tube the control would fire 10°C colder. (You can adjust the thermocouple offset in the Options section of the DynaTrol – See DynaTrol Reference Manual).

#### **USE CAUTION WHEN VIEWING INTO THE KILN**

Use dark glasses (shade number 1.7 to 3.0) to view inside the kiln through the peepholes when firing. These will protect you from the radiant infrared radiation and will also protect your eyes in case the ceramic ware explodes. Do not use regular sunglasses for this.

#### **USE CAUTION WHEN OPENING THE KILN**

- 1) Use heat resistant gloves when opening peephole plugs.
- 2) Use heat resistant gloves when opening a hot lid.
- 3) Do not open the lid when kiln is above 120°C (250°F).

### **POST FIRING CAUTIONS**

#### **CHECK FOR GLAZE AND CERAMIC CHIPS**

Remove any glaze that has splattered on the firebrick or shelves. (Use safety glasses when doing this because glaze can be sharp like broken glass). Vacuum the kiln after each firing.

## **GENERAL MAINTENANCE CAUTIONS**

### **ELECTRICAL SAFETY**

Unplug kiln when servicing it. The elements carry high voltage when switched on and could electrocute you. Troubleshooting tests performed under power should ONLY be done by a licensed electrician.

### **THE WRONG PARTS CAN BE HAZARDOUS**

Off-brand elements, if not designed properly, can present a hazard to the kiln (by drawing too much amperage). The wrong type of fuse, relay, switch or other component can cause a fire or other hazardous condition. An improperly rated lead can cause a fire. Do not substitute or replace any parts with unauthorized products.

### **KILN MODIFICATIONS**

All customer modification is made solely at the risk of the customer. Modifications will void the warranty. L&L takes no responsibility for hazardous conditions created by unauthorized modifications. Any authorization for an engineering change must be in writing from the factory.

### **KILN MAINTENANCE**

See the section at the end of this booklet on periodic maintenance you need to perform on your kiln.

# **INSTALLATION**

## **ELECTRICAL INSTALLATION**

### **VOLTAGE**

EASY-FIRE kilns are wired to work on either 220-240 Volt single phase or 380 to 415 volt three phase wye. **BE SURE TO GROUND THE KILN PROPERLY USING THE GROUND WIRE. AN UNGROUNDED KILN IS A DANGEROUS KILN.** (Also it is important for the control operation to have a good earth ground as well (to get rid of electrical noise).

### **HOOKING UP TO POWER**

Have your electrician install the proper plug and receptacle or direct wire cable and safety switch at your kiln location. Be sure that your fuse ampere capacity is enough to carry the electrical load required. Also, ensure that your power lines are heavy enough to carry the required electrical load.

### **PROTECT POWER LEAD FROM KILN CASE**

Rout Power Lead away from kiln in such a way that it cannot touch the hot case of the kiln. Secure it so it cannot move. If lead touches the hot case it could melt and cause a short circuit and/or fire.

## **EASY-FIRE KILN INSTRUCTIONS (EUROPEAN VERSION) WITH DYNATROL 700**

### **USE A FUSED DISCONNECT**

We recommend having a separate fused disconnect box with a lockout provision mounted near the kiln, even if you also have a separate circuit breaker for your kiln. This way you can easily turn off power to the kiln and prevent unauthorized people from turning it on. We recommend this even for kilns with plugs because it makes it so much easier to disconnect all power to the kiln when not using it. Note that if you unplug a kiln frequently the spring tension in the outlet can weaken over time. A Fused Disconnect switch allows you to positively turn off power to the kiln without unplugging it.

### **LOCATE KILN WITHIN 15 METERS (50 FEET) OF BREAKER**

Try to locate the kiln within 15 Meters (50 feet) of your breaker box. For longer runs you will probably have to increase the size of the hook up wire that we recommend in our literature. In any case, be sure to have a licensed electrician hook up the kiln and size the hook-up wire.

### **FUSING YOUR CIRCUIT**

Be sure your electrician follows the local codes when hooking up the kiln. The full load amps are listed on the data nameplate of the kiln.

### **USE PROPER GROUNDING**

Make sure your electrician properly grounds the kiln and then tests for proper grounding after the installation. All electrical appliances should be properly grounded. This can be to either a cold water pipe or proper system ground in your building. If there is ever a short circuit (where the electricity flows through to the case or control panel and where you might touch it) you could be electrocuted if the kiln is not grounded. This is especially important with the high voltage used on kilns. The higher the voltage the more easily it could flow through your body. In addition, because of the heat generated in a kiln, wires are subject to potential deterioration over time and expansion and contraction can move insulators and cause short circuits. **BE SURE TO REPLACE ANY DETERIORATED WIRES!**

### **USE COPPER WIRE FOR HOOK-UP**

Don't use aluminum wire.

## CONTROL LAYOUT

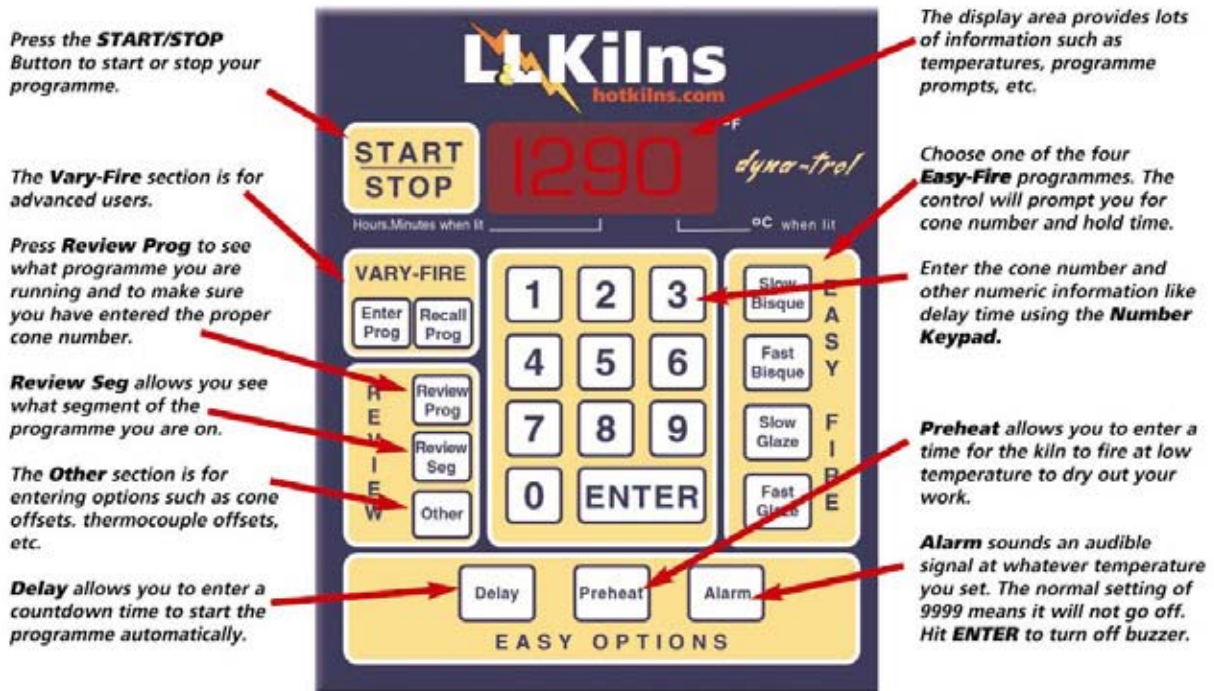

## OPERATION

### HOW YOUR KILN WORKS

The DynaTrol automatic programme control uses two or three separate thermocouples to measure temperature in the top, middle and bottom of the kiln (top and bottom in a two-section kiln). The control automatically adjusts power to evenly heat up the kiln according to the programme you are firing. The four **EASY-FIRE** programmes make firing most ceramics simple. The programmes vary the ramp rates and final temperature reached based on time-proven methods. You do not have to adjust anything once you start firing.



## **USING YOUR KILN**

### **TURNING ON THE KILN**

1. Make sure your circuit breaker or fused disconnect switch is turned on.
2. Make sure the element shut-off switch is turned on. (This is the switch that you have to turn on the lid).
3. Turn on kiln with the toggle On/Off switch on the left side of the control box.

### **WHEN YOU FIRST TURN ON THE KILN**

1. When the kiln is turned on you will see **WAIT** in the DynaTrol display. Wait until you see **IdLE**, **TC2**, and the current temperature cycling over and over in the display.
2. This cycling **IdLE** message means that the Dynatrol is on, ready to be programmed, but the kiln is not firing yet.
3. The current temperature is measured at the tip of the three thermocouples (**TC1**, **TC2**, **TC3**). The default thermocouple reading is **TC2**. In other words unless you specifically ask the control to show you the temperature at **TC1** or **TC3** then it will only show you the temperature at **TC2**. Press the **#1** button to see the temperature at **TC1**, or the **#3** button to see the temperature at **TC3**.

### **IF YOU HAVE A TWO SECTION HIGH KILN**

1. If your kiln has only two thermocouples you will not be able to find **TC3** as there is no third thermocouple. The Dynatrol comes pre-programmed from the factory for your kiln's particular specifications. (Note: if you programmed the control as a single zone control you will only see one temperature and no **TC1**, **TC2** or **TC3** in the display.)

### **EASY-FIRE OPERATION**

1. The EASY-FIRE mode allows you to fire to a CONE NUMBER at one of four different speeds. These are the four preset **EASY-FIRE** programmes that have been designed to do most typical ceramic firing cycles. They are "**Fast Bisque**", "**Slow Bisque**", "**Fast Glaze**" and "**Slow Glaze**". These preset programmes have specific ramps and speeds built into them. (You can find out how these are written in the Appendix of the DynaTrol Reference Section). You can enter any cone number from 022 up to cone 10.
2. **CAUTION:** Follow the recommendations of the clay and glaze manufacturer for proper cone to fire to - and keep in mind that if you don't fire to the proper cone you can cause a major meltdown of your work).
3. You can enter a hold time at that final cone setting. (Be careful because you will add heat-work to load when you add soak time).
4. You can enter a delay time (to prevent the programme from starting for a while).
5. You can enter a preheat time to "candle" the load at **93°C (200°F)** to help dry it out.
6. You can enter a controlled cooling segment, or other custom segments to the end of the easy-fire programme.



## EASY-FIRE KILN INSTRUCTIONS (EUROPEAN VERSION) WITH DYNATROL 700

7. NOTE ABOUT WHAT YOU SEE: Most DynaTrol's will read **93°C (200°F)** during this phase even though actual temperature in the kiln is about **83°C (182°F)**. This is because of the thermocouple **10°C** offset used to compensate for the thermocouple protection tubes. When it is climbing the temperature displayed is the real temperature inside the kiln.
8. The above "**Easy Options**" allow for some degree of customization while still keeping the programming simple and easy.
9. The EASY-FIRE mode uses the Orton Foundation's patented method to achieve the correct heat work making these programmes ideal for firing ceramics. The advantage of using the EASY-FIRE method is that a very complicated firing profile may be chosen with just a few keystrokes. These programme's final temperature set points are based on large Orton self-supporting cone (rather than the small Orton cones or regular large Orton cones). The DynaTrol actually calculates when it should shut off based on what cone number was programmed, and how many degrees per hour the kiln was rising at the end of the firing. The DynaTrol actually adjusts the final set point using Orton's patented formula in these Easy-Fire preset programmes. (NOTE: This is not always true for the Vary-Fire programmes where you can set an absolute final temperature set point).
10. NOTE: "Cones" measure "heat-work" which is measure of the amount of heat imparted to your work over time. It is like baking food – if you heat something slower you don't need to cook it at as high a temperature. So if the kiln is rising in heat at a slow temperature then the final temperature that the kiln reaches does not have to be as high as for a fast firing kiln. Soak time can also be added (carefully) to increase the heat-work.

### WHAT IF YOU MAKE A MISTAKE?

11. NOTE: If you make a mistake while programming (like entering the wrong hold time) and you have already pressed **ENTER**, you must continue to enter the rest of the programme. Once you see **IDLE** (meaning programming is complete) you must then go back and re-enter the programme again.

### FIRING THE KILN

1. Make sure **IdLE**, **TC2**, and the **current temperature** are flashing. This means that the control is not running a programme.
2. Press one of the four easy firing profile buttons: **SLOW BISQUE** or **FAST BISQUE** or **SLOW GLAZE** or **FAST GLAZE**.
3. Press **ENTER**. The display will flash **CONE** and a number representing a cone number (like 06).
4. Enter the cone number you want to fire to (for instance **5**). You can enter any cone number from **022** up to cone **10**. It will not let you put cone numbers in outside of this range. If you type a wrong number, press **0/0/ ENTER** and the previous cone number will reappear in the display. Then type the correct cone number. **BE CAREFUL TO ENTER THE PROPER CONE NUMBER. DO NOT CONFUSE CONE 05 WITH CONE 5 FOR INSTANCE BECAUSE YOU COULD MELT YOUR CONE 05 CLAY.**
5. Press **ENTER**. **HOLD** and **0.00** will flash.
6. Enter a hold time or leave at **0.00**. Numbers to the left of the decimal are hours, to the right are minutes.

## **EASY-FIRE KILN INSTRUCTIONS (EUROPEAN VERSION) WITH DYNATROL 700**

7. Press **ENTER**, then **IdLE, TC2** and the current temperature will flash in the display.
8. Press **START/STOP** to begin firing or read on to enter an optional **Preheat** or **Delay Start** time.
9. When firing is complete the display will flash **CPLT**, the total firing time in hours and minutes (for instance **07.34**) and current temperature inside kiln.

### **ENTERING AN OPTIONAL PREHEAT TIME**

1. With any of the **EASY-FIRE** modes, a preheat stage is available. During the preheat stage the temperature is automatically increased at a rate of **33°C (60°F)** per hour until **93°C (200°F)** is reached; the **93°C (200°F)** temperature is then held for the programmed amount of time.
2. **NOTE:** Remember when the kiln says **93°C (200°F)** it is actually **83°C (182°F)** inside the kiln because of the 10°C thermocouple offset.
3. **Preheat** is automatically set to zero during **EASY-FIRE** programming and at the end of each firing, so if a **Preheat** stage is wanted, it must be reprogrammed for each **EASY-FIRE** firing.
4. To preheat the kiln for a specific amount of time you must first programme an **EASY-FIRE** programme. Once this is done you can add the **Preheat** option to it.
5. Press the **Preheat** button in the **EASY-OPTIONS** Section at the bottom of the control. See **HLd** and **00.00** cycling over and over.
6. Press the number keys to input how long you want the preheat time to be. Numbers to the **LEFT** of the decimal in the display are hours, i.e. 3 hours of preheat time would look like **03.00**. Numbers to the **RIGHT** of the decimal in the display are minutes, i.e. 75 minutes of **Preheat** time would look like **00.75**.
7. Press **ENTER** and see **CPL** meaning that programming the preheat option is complete.
8. Press **START/STOP** to begin firing or read on to enter an optional **Delay** time.

### **ENTERING AN OPTIONAL DELAY START TIME**

1. This feature makes it easy for you to be present at the end of a firing. You can delay the start of the programme by up to 99 hours and 99 minutes.
2. To programme a delay time you need not have programmed any firing profile yet. You can enter a Delay Time at any time the control is not firing the kiln. It will apply to the next programme you run when you hit **START/STOP**.
3. When the display cycles **IdLE, TC2, current temperature** over and over. (Control is not firing)
4. Press the **Delay** button in the **Easy-Options** Section at the bottom of the control. See **dELA** and **0.00** cycling over and over.
5. Press the number keys to enter the amount of delay time desired. Numbers to the **RIGHT** of the decimal in the display are minutes, i.e. 75 minutes of delay time would look like **00.75**. Numbers to the **Left** of the decimal in the display are hours, i.e. 14 hours 30 minutes of delay time would look like **14.30**.
6. Press **ENTER** and see **IdLE**, meaning programming the delay option is complete.

## EASY-FIRE KILN INSTRUCTIONS (EUROPEAN VERSION) WITH DYNATROL 700

7. This delay will appear in the display like a timer counting down when you press **START/STOP** to begin firing. The firing will begin once the timer reaches zero. It will remain set as is until you change it.

### ENTERING AN OPTIONAL ALARM TEMPERATURE

1. The DynaTrol can make an audible sound at some specific temperature. This can be useful to alert you to do something like pay attention to the end of the firing. It is not very loud.
2. You can enter an **Alarm** Temperature at any time the control is not firing the kiln. It will apply to the next programme you run when you hit **START/STOP**.
3. Press the **Alarm** button in the **EASY-OPTIONS** Section at the bottom of the control. See **ALRM** and **9999** cycling over and over. A high value like that means the control will not sound an alarm.
4. Enter a four-digit number like **1000**. (This represents **1000°C**).
5. Hit **ENTER**
6. The display will start flashing **IdLE**, **TC2** and **current temperature**.
7. When you fire now, the alarm will sound at 1000°C. Once it starts to beep, press **ALARM** or **ENTER** to turn it off.
8. NOTE: The sound is not very loud.

### REVIEWING THE PROGRAMME

1. Reviewing your programme before you start (or just after) is very important. It can prevent a serious mistake. In particular check the cone number you are firing to. Also it is useful for obtaining the temperature that you reached on your last firing.
2. In the **Review** section hit **Review Prog** button.
3. The programme will scroll. You will see, in the following order, various aspects of the programme.
  - a) The programme name (like **S-bC** for Slow Bisque, **F-bC** for Fast Bisque, **S-GL** for Slow Glaze and **F-GL** for Fast Glaze)
  - b) **PRHT** followed by its value in time (like **03.00**)
  - c) **CONE** followed by its value (like **05**)
  - d) **oC** (or **oF**) followed by a value like **1031**. This is the final temperature reached on the **LAST** firing.
  - e) **CNOS** followed by **9020** or some other number, which could also be **0000**. The **9020** represents the **Cone Offset** that may be preprogrammed into the control. (See DynaTrol reference manual if you want an explanation of this).
  - f) **HLOd** followed by the value in time like **00.00** of the Hold Time programmed into the control.
  - g) **dELA** followed by the value in time like **02.30** of the **Delay Start Time** programmed into the control.

## EASY-FIRE KILN INSTRUCTIONS (EUROPEAN VERSION) WITH DYNATROL 700

- h) **ALRM** followed by the value in time like **1000** of the **Alarm** Temperature programmed into the control.
  - i) **ERCd** followed by **ON** or **OFF** (See DynaTrol reference manual if you want an explanation of this). Typically Error Codes should be **ON**).
  - j) **FIRE** followed by the number of firings the kiln has done.
4. If you are using the **VARY-FIRE** programmes it will be similar except it will scroll through all the segments, ramps and holds for **USER** programmes.
  5. If you have added controlled coolings or 16-step options there will be a reference to these steps in the Review Program sequence as well. (See the Reference Manual for more information).

### VARY-FIRE OPERATION

1. With the Vary-Fire mode you may programme six different programmes. Each programme can have up to eight segments. Each segment has a ramp rate (set in degrees Fahrenheit or Centigrade, heating or cooling, per hour), a set point temperature (the temperature that ramp rate will heat or cool to) and an optional hold time at that temperature for up to 99 hours and 99 minutes. (As a contrast, in the Easy-Fire mode, the number of segments and the firing profile are preset. In fact you can find these profiles in the Appendix of the DynaTrol Reference Manual. They make a good starting point for creating your own Vary-Fire programmes).
2. When the DynaTrol comes to you new it has programmes already in place in these six programme slots. You can programme over them with your own programmes or simply use the ones in there. These pre-set programmes are outlined in the Reference Manual in Appendix I. In short, they are a glass slumping programme, a glass tack fuse programme, a glass full fuse programme, a glass bead annealing programme, a lost wax burnout programme, and a slow cooling cycle for cone 6 that can be added to an existing programme. Even if you programme over these programmes, you can get them back from memory any time. Unfortunately any programmes you have in there that you have made will be lost if you recall the original default programmes.
3. When programming your programmes, the ramp portion of a segment need not always be increasing in temperature. You can programme a decrease in temperature at a specific rate also. If you wish to use the more sophisticated features and options of the DynaTrol refer to the DynaTrol Reference Manual. There are various samples and great detail about options, troubleshooting and theory.

## EASY-FIRE KILN INSTRUCTIONS (EUROPEAN VERSION) WITH DYNATROL 700

### VARY-FIRE EXAMPLE: USR1 - SLOW BISQUE TO 1015°C WITH 30 MINUTE HOLD

The following steps are used to enter a programme under **USR1** for the firing programme in the below example.

**NOTE:** You can change the programme's name (the **USER** number), change the number of segments, and change the ramping rates, segment setpoints and hold times within each of the segments. You can even add a **Delay** time to ensure that you will be around for the end of the firing, all to fit the programme to your own specific needs.

| Press             | Display  | Comment   |
|-------------------|--|---|
| <b>ENTER PROG</b> | Alternately flashing:<br><b>USER &amp; #</b>   | The display alternates between <b>USER</b> and the last selected firing programme number.   |
| <b>1</b>          | <b>1</b>                                       | Selects <b>USER (USER)</b> programme number <b>1</b> . Only choose <b>USR1</b> if you have not already entered a programme there or if you wish to programme over the programme that is already there. Otherwise select another available programme number (1 through 6). |
| <b>ENTER</b>      | Alternately flashing:<br><b>SEG &amp; No.</b>  | The displays flashes between <b>SEG</b> and the number of segments which were previously selected for this programme.   |
| <b>6</b>          | <b>6</b>                                       | This is the number of segments needed for our example programme.  |
| <b>ENTER</b>      | Alternately flashing:<br><b>RA1 &amp; No.</b>  | The display flashes between <b>RA1</b> and the heating rate per hour of the previously selected for this programme. This is the first ramp.   |
| <b>50</b>         | <b>0050</b>                                    | Displays the selected rate/hour of 50°C per hour. This is the first ramp speed (for segment 1) in your programme.   |
| <b>ENTER</b>      | Alternately flashing:<br><b>°C1 &amp; No.</b>  | The display flashes between <b>°C1</b> & the temperature which was previously selected for this programme.  |
| <b>100</b>        | <b>0100</b>                                    | Displays the selected temperature of 100°C. This is the first set point temperature (for segment 1) in your programme.  |
| <b>ENTER</b>      | Alternately flashing:<br><b>HLd1 &amp; No.</b> | The display flashes between <b>HLd1</b> & the hours and minutes which were previously selected for this profile.  |
| <b>0030</b>       | <b>00.30</b>                                   | Enter a 30 minute Hold Time. This is the first hold time (in segment 1) in your programme.  |
| <b>ENTER</b>      | Alternately flashing:<br><b>RA2 &amp; No.</b>  | The display flashes between <b>RA2</b> & the heating rate previously selected for this programme.   |
| <b>75</b>         | <b>0075</b>                                    | Displays the selected rate/hour of 75°C per hour. This is the second ramp speed (for segment 2) in your programme.  |
| <b>ENTER</b>      | Alternately flashing:<br><b>°C2 &amp; No.</b>  | The display flashes between <b>°C2</b> & the temperature which was previously selected for this programme.  |
| <b>230</b>        | <b>230</b>                                     | Displays the selected temperature of 230°C. This is the second set point temperature (for segment 2) in your programme.   |
| <b>ENTER</b>      | Alternately flashing:<br><b>HLd2 &amp; No.</b> | The displays flashes between <b>HLd2</b> & the previously selected hold time.   |

## EASY-FIRE KILN INSTRUCTIONS (EUROPEAN VERSION) WITH DYNATROL 700

|              |  |  |
|--------------|--|--|
| <b>0000</b>  | <b>00.00</b>                                   | No Hold. This is the second hold time (in segment 2) in your programme. You have to have some value in here because every segment has a hold time. When you put in <b>0000</b> it tells the control to immediately move to the next segment without holding. |
| <b>ENTER</b> | Alternately flashing:<br><b>RA3 &amp; No.</b>  | The display flashes between <b>RA3</b> & the heating rate previously selected for this profile.  |
| <b>180</b>   | <b>0180</b>                                    | Displays the selected rate/hour of 180°C per hour. This is the third ramp speed (for segment 3) in your programme.   |
| <b>ENTER</b> | Alternately flashing:<br><b>°C3 &amp; No.</b>  | The display flashes between <b>°C3</b> & the temperature which was previously selected for this programme.   |
| <b>545</b>   | <b>0545</b>                                    | Displays the selected temperature of 545°C. This is the third set point temperature (for segment 3) in your programme.   |
| <b>ENTER</b> | Alternately flashing:<br><b>HLd3 &amp; No.</b> | The displays flashes between <b>HLd3</b> & the previously selected hold time.  |
| <b>0</b>     | <b>00.00</b>                                   | No hold time. This is the third hold time (in segment 3) in your programme.  |
| <b>ENTER</b> | Alternately flashing:<br><b>RA4 &amp; No.</b>  | The display flashes between <b>RA4</b> & the heating rate previously selected for this programme.  |
| <b>100</b>   | <b>0100</b>                                    | Displays the selected rate/hour of 100°C per hour. This is the forth ramp speed (for segment 4) in your programme.   |
| <b>ENTER</b> | Alternately flashing:<br><b>°C4 &amp; No.</b>  | The display flashes between <b>°C4</b> & the temperature which was previously selected for this programme.   |
| <b>645</b>   | <b>0645</b>                                    | Displays the selected temperature of 645°C. This is the forth set point temperature (for segment 4) in your programme.   |
| <b>ENTER</b> | Alternately flashing:<br><b>HLd4 &amp; No.</b> | The displays flashes between <b>HLd4</b> & the previously selected hold time. This is the forth hold time (in segment 4) in your programme.  |
| <b>0</b>     | <b>00.00</b>                                   | No hold time. This is the forth hold time (in segment 4) in your programme.  |
| <b>ENTER</b> | Alternately flashing:<br><b>RA5 &amp; No.</b>  | The display flashes between <b>RA5</b> & the heating rate previously selected for this programme.  |
| <b>180</b>   | <b>0180</b>                                    | Displays the selected rate/hour of 180°C per hour. This is the fifth ramp speed (for segment 5) in your programme.   |
| <b>ENTER</b> | Alternately flashing:<br><b>°C5 &amp; No.</b>  | The display flashes between <b>°C5</b> & the temperature which was previously selected for this programme.   |
| <b>915</b>   | <b>0915</b>                                    | Displays the selected temperature of 915°C. This is the fifth set point temperature (for segment 5) in your programme.   |
| <b>ENTER</b> | Alternately flashing:<br><b>HLd5 &amp; No.</b> | The displays flashes between <b>HLd5</b> & the previously selected hold time.  |
| <b>0</b>     | <b>00.00</b>                                   | No hold time. This is the fifth hold time (in segment 5) in your programme.  |

## EASY-FIRE KILN INSTRUCTIONS (EUROPEAN VERSION) WITH DYNATROL 700

|              |   |   |
|--------------|---|---|
| <b>ENTER</b> | Alternately flashing:<br><b>RAb &amp; No.</b>             | The display flashes between <b>RAb</b> & the heating rate previously selected for this programme.   |
| <b>100</b>   | <b>0100</b>   | Displays the selected rate/hour of 100°C per hour. This is the sixth and final ramp speed (for segment 6) in your programme.  |
| <b>ENTER</b> | Alternately flashing:<br><b>°Cb &amp; No.</b>             | The display flashes between <b>°Cb</b> & the temperature which was previously selected for this profile   |
| <b>1015</b>  | <b>1015</b>   | Displays the selected temperature of 1015°C. This is the sixth and final set point temperature (for segment 6) in your programme.   |
| <b>ENTER</b> | Alternately flashing:<br><b>HLdb &amp; No.</b>            | The displays flashes between <b>HLdb</b> & the previously selected hold time.   |
| <b>0030</b>  | <b>00.30</b>  | 30 minutes hold time. This is the sixth and final hold time (in segment 6) in your programme.   |
| <b>ENTER</b> | Alternately flashing:<br><b>ALAr &amp; No.</b>            | The display alternates between <b>ALAr</b> & the previously used alarm setting.   |
| <b>1000</b>  | <b>1000</b>   | Enters the temperature at which the alarm will sound. This setting will alert you that the kiln is reaching its final set point. The alarm will be turned off with a setting of <b>9999</b> . (the control will never reach that temperature and hence will not sound). |
| <b>ENTER</b> | <b>CPL</b> flashes then the<br><b>current temperature</b> | <b>CPL</b> flashes several times indicating the programme has been completed. The current temperature then flashes in the display.  |

### CONTROLLED COOLING

1. If your kiln is cooling too rapidly for good glaze results, or if the cooling is so rapid that cracking occurs on certain large pieces, it is recommended to cool under power. This is accomplished using the following instructions.
2. The Easy-Fire to Vary-Fire feature allows you to fire an Easy-Fire programme and then automatically start a Vary-Fire programme at the end of the Easy-Fire programme. The Vary-Fire to Cone feature allows you to enter a sophisticated Vary-Fire programme that fires to a cone number, not to a specific temp.
3. There are complete sections on these subjects along with a step-by-step examples, in the DynaTrol Reference Manual.

### CHECKING TEMPERATURE & TIME REACHED

1. When an Easy-Fire programme is complete it will tell you how long it took to finish the programme, and what the temperature is as the kiln cools off.
2. At the end of the programme the control will flash **CPLT** and a number like **7.34**. The **7** stands for hours and the **34** stands for minutes. This is how long it took for the kiln to reach final set point. It will also show you the temperature inside the kiln as it cools off.
3. Hit **START/STOP**. You will then see **STOP**.
4. Press **Review Prog**. The display will scroll through the entire programme and will show you the actual temperature reached.



## EASY-FIRE KILN INSTRUCTIONS (EUROPEAN VERSION) WITH DYNATROL 700

### FOR MORE INFORMATION

1. See the various instruction sheets about cones in the LOG, CONES, TIPS, CERAMIC PROCESS section.

### MISC NOTES AND OVERVIEW

1. The DynaTrol controls your kiln by firing programmes you choose from a bank of available programmes in its memory. It has four preset programmes: Slow Bisque, Fast Bisque, Slow Glaze and Fast Glaze for any cone number; cone 022 through cone 10. In addition it has six specialized programmes for glass and jewelry which can be replaced by your own custom programmes, or recalled at any time
2. To any of these four pre-set programmes, you have the option of including a **PREHEAT** to the beginning (for drying). You also have the option of adding a **DELAY** time to delay the start time of the entire programme as well. Both of these options are things that you add to a programme.
3. You cannot erase something you have entered. You can only programme over it. Say you enter the wrong programme, a Slow Glaze instead of a Slow Bisque. You must go ahead and programme the whole wrong programme with any cone numbers etc, then go and enter the correct programme right over top of the wrong one. A preheat must be entered with the regular programme every time you want one. The DynaTrol will not remember that you always/never use a preheat with that particular programme. Delayed Starts will stay in effect regardless of what else is programmed, until you actually press **DELAY** and change it.
4. Always press **Review Pro** to see what programme is ready to be fired.

### OBTAINING FIRING INFORMATION

1. There are a number of keys that you can push while the control is operating to get information.
2. Press "1", "2" or "3" while firing to change which thermocouple reading you see in the LED display.
3. Press **8** while firing to turn **On/Off** the ability to see which zones are firing by the LED display dots. Dot on the left is the top zone, dot in the center is the center zone, and the dot on the right is the bottom zone. Don't forget that the dot on the very far right is only on if you are running in Celsius temp scale.
4. Press **5** while firing and see the current rate of climbing in degrees per hour. This is useful to look at near the end of the programme so you can look on a cone chart to accurately see what temperature your kiln will shut off.
5. Press **0** while firing to see how much time has elapsed since the programme began.
6. Press **Review Prog** - The information displayed when Review Program is pressed varies depending on whether you are using **EASY-FIRE** or **VARY-FIRE**. When Review Program is pressed, each of the steps in the current firing profile is displayed one after another.
7. When a firing is complete, **Review Prog** is used to see the final temperature reached during the firing.
8. Press **Review Seg** - to view the current firing segment or to skip from the current segment to the next segment. When Preview Seg is pressed during a firing the current stage of the firing is displayed. If it is pressed in between firings, **STOP** will flash and then the current temperature

## **EASY-FIRE KILN INSTRUCTIONS (EUROPEAN VERSION) WITH DYNATROL 700**

will be displayed. When you press **Preview Seg** twice you will see the programme set point temperature. When you press it three times you will see the control board temperature.

### **ERROR CODES & DIAGNOSTICS**

1. See Appendix G in the DynaTrol Reference Manual for a list of error codes and their meanings.
2. See the DynaTrol Reference Manual for extensive information on how to troubleshoot a firing, in particular Section 4.4.

### **UNDERSTANDING THE DISPLAY**

3. See Appendix D in the DynaTrol Reference Manual for a list of all the displays and their meanings.

## **FIRST TEST FIRING OF THE KILN**

### **WHEN TO DO A FIRST TEST FIRING?**

Once your kiln is set up, leveled properly (very important), control panel hooked up to the kiln correctly and all the power wired properly, you are ready for your first firing.

### **WHY DO A TEST FIRING?**

1. The test firing is done very slowly, about 19 hours total to minimize the inner and outer surface temperature differences in the kiln while it goes through its first firing. Also this will slowly boil off any moisture absorbed by the firebrick during construction, shipping, and storage.
2. The test firing is done to cone 5 (about **1186°C / 2167°F**) to vitrify the special coating on the inside on the firebrick and to allow an “aluminum oxide” coating to form on the element’s surfaces. The coating on the brick helps to reflect the heat radiated from the elements. The oxide layer on the elements helps to protect them from the many contaminants found in many materials fired in a kiln. This aluminum oxide layer will rejuvenate itself every time there is an oxygen rich firing to a high temperature. Going to cone 5 may also point out any problems with your electrical service - like low or incorrect voltage or wrong supply line wire size. The elements will also seat themselves in the ceramic holders - and any springiness you see when you first get your kiln will be alleviated.
3. The test firing is done with the operator present as much as possible. This is to be sure the kiln is heating up safely, and that the heating kiln affects nothing else in the room or the room itself. As for the operator being present, logistically this may be difficult as the test fire is designed to take about 19 hours. To deal with this a “Delayed Start” can be added to the test fire programme, allowing you to press **STOP/START** at say **17:00**, the kiln to start at say **20:00** in order to turn off at **14:00** the following day while you are there. More detail on this a little further on. You can also split it into two firings (see instructions at the end of this sheet).
4. The test fire is done with the kiln empty, or with the new kiln furniture. Anything else in the kiln (clay) will produce contaminants to some degree, and the elements in the kiln have not yet achieved this all important aluminum oxide coating before being subjected to these contaminants.

# **EASY-FIRE KILN INSTRUCTIONS (EUROPEAN VERSION) WITH DYNATROL 700**

## **VENTING**

1. If you have an automatic Vent-Sure system, leave it on while firing. If you have no vent system then leave the top peephole plug(s) out during the first test firing.

## **WHAT TO EXPECT DURING THE FIRST FIRING**

### **ELEMENT SMOKING**

1. Brand new elements will smoke a little initially the first time they are heated. A fan in a window is more than adequate to deal with this.

### **NOISES IN AN AUTOMATIC KILN**

1. A Beep when you press a button on the DynaTrol keypad.
2. Clicking noises from inside the control box as the unit heats. This will happen throughout the firing until it shuts off. Sometimes it will happen more frequently than other times. It is the result of the relays opening and closing as the control tells them to, turning the electricity on or off to the elements, working to heat the kiln evenly.
3. Hum. Whenever kiln elements come on they are accompanied by a humming sound from electricity in the elements. This is normal. The natural properties of electricity and the dynamics of the shape of the element combine to make a slight vibration in the element.

### **WHAT HAPPENS AS THE KILN HEATS UP**

1. All the materials used in the kiln's construction expand incrementally as they are heated. First the inside materials- i.e. the elements, holders, and inside surfaces of the walls, floor, and lid heat and expand slightly. Then, the heat moves slowly through the walls, lid and floor until it begins to heat the outer surface of the kiln. The greater the difference in temperature is between the inside surface vs. outside surface, the more stress there is on the material itself.
2. Walls, lids and floors can sometimes hairline-crack on the surface or in the some cases, all the way through. This is normal and to be expected sooner or later to some degree. If you tighten the stainless steel bands that surround the floor, lid, and walls of the kiln every so often, the fact that the firebrick expands as it heats will mean that the cracks are actually closing up while the kiln is heating, expanding against the cooler outer shell. The geometry of the kiln and the tightness of the stainless steel bands are what hold everything together, whether the brick is in a few pieces or all one piece should not matter a whole lot
3. Sometimes you will also get hairline cracks in the floor. Because this is fully supported and banded on the outside this is not a problem.
4. Hairline cracks on the top can also develop. Because of the banding and the "U" shaped stainless brick supports this is also not a problem.

### **VISIBLE RED HEAT**

1. Another thing to expect is to see the "red heat" through the seams, between the sections of the kiln, beginning around 535°C (1000°F). This is normal. The seam between the lid and the top

## **EASY-FIRE KILN INSTRUCTIONS (EUROPEAN VERSION) WITH DYNATROL 700**

section will probably appear the largest. This is partly because, when the top heats up, it becomes slightly concave and the edge lifts up.

2. The outer metal and brick surfaces of the kiln will get very hot, as hot as 230°C (450°F) - easily hot enough to burn you.
3. The interior of the kiln will look white hot at the highest temperatures. **CAUTION:** Be sure to always use kiln safety glasses when looking through the peepholes to protect your eyes from infrared radiation.

### **CONTROL DISPLAY ON DYNATROL**

1. Acronyms on the DynaTrol's display screen stand for important messages, they are its way of communicating with the USER: For instance, **tCOS** is the acronym the DynaTrol uses for "thermocouple offset". The DynaTrol display is limited to four letters or numbers at a time. Appendix E in the DynaTrol reference manual shows what the different acronyms mean.
2. Once it hits its target temperature, it will shut off with a **CPLT** message. Once this message is seen the kiln is no longer running. It is safe to shut off the power to it. If no controlled cool-down was programmed, the kiln will cool quickly at first, then more and more slowly. As it is cooling it will display the **CPLT**, the amount of time it took to complete the firing, the **TC2**, and the **current temperature** over and over again.
3. The temperature will normally be displayed from **TC2**, which is thermocouple number two. Press **#1** to see the temperature in the top section- **TC1**. Press **#3** to see the temperature in the bottom section of a three or more section kiln. The DynaTrol is checking all three thermocouples every eight seconds even though just one thermocouple's temperature is displayed. The displayed temperature will rise as the kiln heats up, cycling from **TC2** to current temperature inside the kiln over and over again. (A kiln with just one thermocouple will just show the temperature reading, no **tC** number).

## **STEP BY STEP FIRST FIRING INSTRUCTIONS**

1. Power to the kiln is on (kiln is plugged in); turn the toggle switch on, display reads **ErrP** or **STOP**.
2. Press **#1** and wait until you see **IdLE**, **TC2**, and the current temperature cycling over and over again.
3. Press **SLOW BISQUE** and see **S-bc**.
4. Press **ENTER** and see **ConE**, and a number (which represents the cone number currently programmed in the control) flashing back and forth.
5. Press **5**, and see the number **5** in the display. If you wait it will flash with **ConE**.
6. Press **ENTER** and see **Hld**, **00.00** flashing back and forth.
7. Press **ENTER** and see **CPL** for about three seconds, then see **IdLE**, **TC2**, and the **current temperature** cycling over and over.
8. Press the **PREHEAT** button in the **EASY-OPTIONS** section.
9. See **Hld**, **00.00** flashing.

## EASY-FIRE KILN INSTRUCTIONS (EUROPEAN VERSION) WITH DYNATROL 700

10. Press **300** so the display reads **03.00**.
11. Press **ENTER** and see **CPL**.
12. Press **START/STOP** to begin the test firing.
13. You have just entered an “Easy-Fire Slow Bisque” Programme to cone 5 with a three hour preheat, the combined total of which will take roughly 19 hours. The preheat part increases the heat in the kiln at **33°C (60°F)** per hour from room temperature up to **65°C (150°F)** where the hold time comes on, the timer appears, and it holds at **65°C (150°F)** for the set amount of time. Once the timer runs out, the rest of the programme follows.
14. Now you must figure out how to be around for the end of the 19-hour firing. This is where the **DELAY** Start feature may come in handy. It is a digital hours and minutes timer you can add to the beginning of any programme. You tell the timer how many hours and minutes to count down before the DynaTrol turns up the kiln and runs the rest of the programme.
15. **CAUTION:** Again, it is critical for someone to be present especially at the end of the firing, and especially for this first firing.

### DO YOU NEED A DELAYED START?

1. Picture a clock-face and count forward 19 hours from when you planned to press **START/STOP** to begin this programme. Will you be present for at least the last four hours? If “YES” then you do not need a delayed start time and you can start the firing when you planned to, skip the rest of step 6 and step 7. If “NO” then you do need a delayed start time, continue on here.

### CALCULATING THE DELAY START

1. Picture the same clock-face, and see when the firing would have ended if you had pressed **START/STOP** when you planned (i.e. 19 hours from when you want the firing to begin). Now picture how many hours later the firing would have to end, in order to have someone there for the last four hours of this 19-hour firing. That “number of hours later” is what to programme in for the Delay Start.
2. **AN EXAMPLE:** You are planning to start the programme at 16:00. Your programme is going to take 19 hours. 19 hours from 16:00 is 11:00 the following day. You plan to get into the kiln room at 8:00. 8:00 to 11:00 is three hours. You would need to get there one hour earlier to be there for the last four hours, OR start the programme one hour later than 16:00 so that the programme completes at 24:00. You will need to programme a one hour delayed start. First you will enter the programme, then the preheat, then the delayed start. You will press **START/STOP** at 16:00, but now a timer will appear and count down the one-hour before the rest of the programme begins.

### ADDING A DELAYED START

1. Press **DELAY** and see **dELA, 00.00** flashing over and over.
2. Enter the number of hours and minutes to delay the start for. For example: For a two-hour delay press **2, 0, 0** so it says **02.00**. For a 1 hour and thirty minute delay press **1, 3, 0** so it says **01.30**. Numbers in the display to the right of the decimal represent minutes. Numbers to the left of the decimal represent hours.
3. When the correct number of hours and minutes has been keyed in, press **ENTER**, see **CPL**

## EASY-FIRE KILN INSTRUCTIONS (EUROPEAN VERSION) WITH DYNATROL 700

### START FIRING

1. When the correct time to begin the firing arrives, press **START/STOP**. The display will say **-On-**. Then it will cycle through a sequence showing **TC2**, and the **current temperature** in the kiln over and over as it heats. Here is what to expect the kiln will do based on what you have programmed, after you press **START/STOP**:
2. If you programmed a delayed start, there will be an **hours and minutes timer** displayed along with the **TC2, current temperature** message. It will be displayed until the timer runs out.
3. It will climb at about **33°C (60°F)** per hour until it reaches **65°C (150°F)**, then the timer will appear again and the three hour preheat will begin counting down on the display with the **TC2, current temperature** message. It will hold around **65°C (150°F)** until the timer runs out.
4. Now it will begin to climb at about **44°C (80°F)** per hour up to **121°C (250°F)**
5. Once the average of all thermocouple readings reaches **121°C (250°F)**, the kiln will begin climbing at **111°C (200°F)** per hour until it reaches **538°C (1000°F)**.
6. Once the average of all thermocouple readings reaches **538°C (1000°F)**, the kiln will begin climbing at **56°C (100°F)** per hour until it reaches **593°C (1100°F)**.
7. Once the average of all thermocouple readings reaches **593°C (1100°F)**, the kiln will begin climbing at **100°C (180°F)** per hour until it reaches **1046°C (1915°F)**.
8. Once the average of all thermocouple readings reaches **1046°C (1915°F)**, the kiln will begin climbing at **44°C (80°F)** per hour until it reaches **1185°C (2165°F)**.
9. Once the average of all thermocouple readings reaches **1185°C (2165°F)**, the kiln display will say **CPLT**, a time like **19.47**, the **TC2**, and the **current temperature** in the kiln as it is cooling.
10. Once **CPLT** is seen the firing is complete. It is best to now shut all power to the kiln off. It is safe to leave the display on with the current messages cycling over and over, or it is also safe to press **START/STOP** to get back to **IdLE, TC2, current temperature** and leave it there.
11. **NOTE:** If the first firing ended in an error code please make note of which one it was; i.e. **ERR1** or **ERRd** etc, and call your distributor.

### SPLITTING TEST FIRING INTO TWO FIRINGS

1. This is done by entering in the standard programme for the test fire on Day 1, first thing in the morning. Turn this on as early on Day 1 as possible and let it run all day until you go home in the afternoon. Before you go home Press **START/STOP**, then turn off the kiln.
2. On day 2, first thing in the morning, programme in a **SLOW GLAZE** to cone 5, no hold or preheat is necessary. Regardless of how hot it still may be in the kiln, turn this programme on as early as possible in the morning on Day 2. It will run up to somewhere between **1170°C (2140°F)** and **1200°C (2200°F)** in about 7 to 8 hours. If it is still not done when you go home, as long as 8 hours have passed since you turned it on, you can press **START/STOP** and turn the toggle switch off and go home. Otherwise when it is done it will give the **CPLT** message and it is then safe to Press **START/STOP**, turn the toggle switch off and go home.



## **CALIBRATING THE CONTROL**

### **ADJUSTING THERMOCOUPLE OFFSET**

1. The industrial thermocouple protection tubes that are used in your Easy-Fire kiln have many advantages such as long thermocouple life, clean operation (no metallic spalling) and inexpensive replacement cost. However, they do introduce a known error into the system. The thickness of the ceramic tube creates an offset in measured temperature vs the actual kiln temperature. The composition of the tube makes a difference in the necessary offsets. This has changed as we have improved the tube and the offsets preprogrammed into the control reflect the testing that we do in the factory.
2. If you are going to be using the **VARY-FIRE** programmes then Cone Offset won't do anything.
3. See section 4.3.3.5 in the DynaTrol Reference Manual for information on how to change Cone Offsets and section 4.3.3.8 to change Thermocouple Offsets (that is also described just ahead). The **RESET** option in **OTHER** will NOT reset these settings.

### **CALIBRATING THE CONTROL**

1. Some people say their new kiln does not get to temperature during the test firing. There are generally two reasons for this. One reason is that the kiln is empty. Another reason is that the kiln cannot be calibrated until it has reached temperature and melted a cone so someone can see how close it really is, and then adjust it accordingly. (We do not fire the kiln before it ships). The thermocouples can be +/- 5°C when they are brand new.

### **EMPTY KILN VS. FULL**

1. One difference between an empty and full kiln is that an empty kiln cools a lot quicker which will freeze the cone very quickly. In a full kiln there is a lot of mass in the kiln that is just as hot as the kiln around it. It is this mass (the load in the kiln), radiating it's heat as well, that will continue to melt the cone for a little longer after the kiln has been shut down. Once the kiln is fine-tuned, it is this variable - how you have loaded the kiln- that will account for many of the variations you will see from firing to firing. Another difference is the speed of firing - an empty kiln will fire differently than a full one. Although the control does compensate for this that compensation is not totally perfect.

### **FINE TUNING THE KILN**

1. You can fine-tune how hot the kiln gets by adjusting the thermocouple offset.
2. If you can tell the cone bent at all during the first firing, but no more than a little bit, then you can start by reducing the thermocouple offset setting by 3°C.
3. If you can tell the cone did not bend at all, then you can start by reducing the thermocouple offset setting by 5°C
4. If it bend more than a little bit, you might wait and see how it does with a load, or start by reducing the thermocouple offset settings just 3°C and then see.
5. If the cone bent too much you should start by increasing the thermocouple offset by 3°C.



## **EASY-FIRE KILN INSTRUCTIONS (EUROPEAN VERSION) WITH DYNATROL 700**

6. **REMEMBER THIS:** Adding thermocouple offset lowers the temperature in the kiln, subtracting thermocouple offset raises the temperature. We suggest tuning the kiln for your glaze firings which are more critical and then using cone offsets to adjust bisque temperatures (if you need to).

### **STEP BY STEP**

1. Turn kiln on with toggle switch. Wait 5 seconds.
2. Press **1**, wait 5 seconds. The kiln display will say **STOP** and then go into **IdLE** mode.
3. Press **OTHER** about eight times until you see **TCOS**
4. Press **ENTER**. See **TC 1**
5. Press **ENTER** again
6. It will flash between **°COS** (which stands for Deg C Offset) and **0010** (The **0010** stands for a thermocouple offset of 10°C - which comes preprogrammed into the control to compensate for the ceramic protection tubes. By changing the offset to 0007 we are **REDUCING** the offset by 3°C- making it fire 3°C hotter).
7. Press **0007** to reduce thermocouple offset by 3°C.
8. or Press **0005** to reduce thermocouple offset by 5°C.
9. Press **ENTER** to accept your input.
10. Do the same for all your thermocouples. The prompts will scroll past in the order of **TC1**, **TC2** and **TC3**.

### **CONE OFFSETS**

1. Tune your kiln using the thermocouple offset for your most critical firing (typically glaze firings). Then use the cone offset to adjust for other cones that you fire to to get them just right (if they are critical). Typically bisque firings are not very critical. See section 4.3.3.5 in the DynaTrol Reference manual for instructions.

# THE KILN DESIGN

## **SECTIONAL CONSTRUCTION**

The Easy-Fire kilns are made up of two or three separate sections that sit on top of a separate kiln bottom. They are attached together by the control panel and hinge.

## **CONTROL SYSTEM**

The automatic programme control uses thermocouples to sense temperature. The control then automatically adjusts power output (turns the contactor on and off) to heat up the kiln. The programme control varies the target set point for the temperature according to various ramps and soak periods that are programmed in the control.

## **THERMOCOUPLE**

The standard thermocouple is a heavy-duty 8-gauge type K thermocouple protected with an industrial grade mullite thermocouple protection tube.

## **REMOVABLE CONTROL BOX**

The control panel can be easily removed and sent to your distributor for repairs if ever necessary.

## **HEATING ELEMENTS IN CERAMIC HOLDERS**

The heating elements are designed to have a low watt density and good stretch ratio. These are supported in hard ceramic element holders (a unique L&L feature). This will promote long element and firebrick life.

## **STURDY ALUMINISED STEEL STAND**

Aluminised steel resists corrosion at the high temperatures. The stand has a full plate of aluminised steel under the bottom brick. This allows the bottom brick to move freely while expanding and contracting - which helps prevent broken bottoms. The legs, which have two bends for stiffness, are bolted onto the stand plates. There are plastic feet that slip over the metal legs.

## **REVERSIBLE BOTTOM**

The brick bottom can be easily reversed in case of a firing mishap.

## **STAINLESS STEEL CASE**

This resists most corrosion and strengthens construction. Stainless steel screws are used in case construction.

## **THREE CASE CLAMPS PER SECTION**

The case of each kiln section is held together by three adjustable stainless steel hose clamps. The clamps are easily accessible for occasional tightening.

# **EASY-FIRE KILN INSTRUCTIONS (EUROPEAN VERSION) WITH DYNATROL 700**

## **"EASY-OPEN, EASY-LOAD" LID**

On all but the e18S and e18T models, the 'Easy-Open, Easy-Load' spring-assisted hinge is counterbalanced with a torsion spring which dramatically lightens the weight of the lid and makes it easy to open and close. A lighter lid also reduces lid and top edge damage. A spring loaded safety latch holds the lid in place while loading. The lid, when open, is tilted away from the kiln opening allowing greater access to the interior. There are no lid supports in the way when loading your kiln. You can safely and easily load from both sides. The hinge extends over three kiln sections and ties the kiln together for stability. All hinge parts are aluminised steel for corrosion resistance.

## **STAINLESS CLIPS HOLD BRICK LID IN PLACE**

Stainless steel "U" clips hold the firebrick in the lid band.

## **76 mm (3") OF INSULATION**

The insulation is a special hand picked lightweight highly insulating firebrick, which is 76mm (3") thick for all European models.

## **LARGE DIAMETER PEEP & VENT HOLES**

There is one 25 mm (1") diameter peephole per section for ventilation and cone sighting. In addition there is one vent hole in the top of the e18S and e18T models and two in the top of all other models for manual venting.

## **CONTROL SYSTEM**

The DynaTrol automatic programme control uses two or three separate thermocouples to sense temperature in each of the two or three zones. The control then automatically adjusts power output (turns the contactors for each zone on and off) to evenly heat up the kiln. The DynaTrol is a programme control, which varies the target set point for the temperature according to various ramps and soak periods that are programmed in the control.

## **VENT-SURE VENT OPTION**

The optional Vent-Sure automatic kiln ventilation system by L&L vents harmful fumes away from a kiln to the outside. Carbonaceous materials in clay, china paints and glazes containing oils, glue from decals, and certain glazes and other miscellaneous products generate fumes.

## **CE CERTIFIED**

All Easy-Fire European model kilns are CE certified.

## **ELEMENT SHUT-OFF SAFETY SWITCH**

A locking door safety switch shuts off all power to the elements when the door is open. This positive system breaks all power and does not rely on a relay.

# LIMITED WARRANTY

## **(3) THREE YEAR LIMITED WARRANTY**

L&L Kilns and vents are warranted to be free of defects in workmanship for a period of three (3) years, starting on the date of original purchase from an authorized L&L distributor, subject to the following terms, including but not limited to, the exclusions and limitations set forth herein. A sales receipt is required for proof of purchase. In addition, your distributor may require you to deliver defective parts for examination. **DO NOT DISCARD PARTS BEFORE CONTACTING DISTRIBUTOR FOR INSTRUCTIONS. FAILURE TO ADHERE TO L&L's INSTRUCTIONS, INCLUDING THOSE CONTAINED IN THE INSTRUCTION MANUAL AND AS STATED HEREIN, WILL VOID THIS WARRANTY.** L&L will replace or repair any defective part that is covered by this warranty and sent freight-prepaid to your local distributor. On-site labor is not covered by this warranty.

## **EXCLUSIONS AND LIMITATIONS**

The following are examples of items that are not covered by and/or circumstances that will void L&L's warranties:

1. Over-firing damage regardless of cause for the over firing. **IMPORTANT:** We specifically warn you not to fire the kiln unattended. No kiln controls are designed to be fail proof shut off devices. L&L is not responsible for damage caused by failure of one of these controls. Kiln should not be left unattended especially during its last phase of firing when it is supposed to stop firing.
2. Reduction firing or salt glaze use of kiln.
3. Damage due to: neglect, mechanical abuse, improper storage, inadequate maintenance, improper use or freight damage.
4. Damage to the elements or element holders due to failure to properly keep the kiln clean (i.e. getting glaze all over the element holders).
5. Damage to the elements or element holders due to failure to properly keep the kiln clean (i.e. allowing glaze to make contact with the element holders).
6. Severe corrosion due to improper venting of kiln fumes or exposure to the ambient conditions, including but not limited to rain, snow, dust, and salt air.
7. Damage due to improper electrical installations or use of improper voltage.
8. Firebrick cracking or chipping for any reason. Firebrick is naturally fragile and will chip and crack over time.
9. Failure to report defect within ten (10) days after it becomes manifest or known.
10. Any alteration of parts or design that vary from factory designs.
11. Use of elements and/or other parts other than those supplied by L&L or it's authorized distributors.

## **EASY-FIRE KILN INSTRUCTIONS (EUROPEAN VERSION) WITH DYNATROL 700**

12. Thermocouple Protection Tubes are not warranted against breakage.
13. L&L's warranty is strictly limited to repair or replacement of defective items. Kilns cannot be returned.
14. Dealers and Distributors are not authorized by L&L to modify and/or assume any other obligations or liabilities other than those expressed in this limited warranty and any such additional obligations are null and void.
15. EXCEPT AS SPECIFICALLY WARRANTED HEREIN, KILNS ARE SOLD AS IS. L&L MAKES NO OTHER WARRANTY, EXPRESS OR IMPLIED, COVERING THE GOODS SOLD AND SPECIFICALLY DISCLAIMS ALL IMPLIED WARRANTIES OF MERCHANTABILITY OR FITNESS FOR A PARTICULAR PURPOSE. Purchaser acknowledges that certain conditions or circumstances may be created or incurred by Purchaser or USER over which L&L has no control, including, but not limited to, climatic conditions, improper use, and inadequate maintenance. Purchaser, as a condition of purchase or use, assumes responsibility for and releases L&L from all liability arising out of the use of the kilns attributable to such causes.
16. L&L SHALL NOT BE LIABLE FOR ANY INCIDENTAL OR CONSEQUENTIAL DAMAGES, INCLUDING BUT NOT LIMITED TO, LOST PROFITS, LOSS OF USE, OR OTHER ECONOMIC LOSSES. Purchaser agrees that L&L's total liability for any damages or remedies arising hereunder shall be limited to direct damages in an amount not exceeding the purchase price paid, and the provisions set forth herein constitute the exclusive remedy against, and the entire liability of, L&L in connection therewith. Any action for breach of contract or negligence must be commenced by Purchaser within one (1) year after the cause of action has accrued.

### **ONE YEAR ELEMENT & THERMOCOUPLE WARRANTY**

Elements and thermocouples are warranted for one year with the following exceptions:

1. Glaze damage to element caused by accidentally scraping edges of unfired glazed ware against element groove and causing unfired glaze to contaminate element, which causes obvious damage to elements with resultant element failure.
2. Firing of kiln to higher than 1290°C (2350°F).
3. Damage to elements caused by explosion of ceramic object. This may cause small pieces of clay to contaminate the element and cause failure.

# SERVICE

## **TROUBLESHOOTING**

See the separate TROUBLESHOOTING SECTION in the Reference Manual

## **ELECTRICAL SPECIFICATIONS & WIRING DIAGRAMS**

See the Reference Manual.

## **REPLACEMENT PARTS**

Parts can be obtained from your local distributor. See PARTS LIST in Reference Manual.

## **REPAIRING OR REPLACING THE CONTROL PANEL**

The control panel is removable from the kiln. This unique L&L Kiln design feature allows easy repair of your control panel. Disconnect power, unplug the kiln, remove panel (see the reference manual for details), pack it carefully in a box with protective cushioning, and send it to your local distributor for inspection and/or repair.

## **CRACKS IN THE TOP & BOTTOM**

It is quite normal to get hairline cracks in both the top and the bottom firebricks. They are caused by the expansion and contraction of the firebrick as it heats and cools. As long as the bottom is fully supported by the stand the cracks in the bottom will not adversely affect the operation of the kiln. It generally does not make sense to cement these hairline cracks.

# REGULAR KILN MAINTENANCE

## AFTER EACH FIRING

1. Unplug the kiln or turn off at the fused disconnect box.
2. Check element holders and walls for glaze, clay chips or anything that could melt at a high temperature. If melted clay or glaze comes in contact with an element, a rapid failure could result. To clean holders, a good shop vacuum will handle dust and loose crumbs. A very gentle chisel or grinder may help with glaze contamination on element holders, but remember that the elements themselves are quite brittle when they are cool. Replace the contaminated holder if you cannot clean it. Remove any glaze that has splattered on the firebrick or shelves. (USE SAFETY GLASSES WHEN DOING THIS BECAUSE GLAZE CAN BE LIKE BROKEN GLASS). Vacuum afterward. Make sure vacuum is grounded and periodically touch some grounded metal surface away from the kiln to discharge the energy while vacuuming (to protect control from static electricity).
3. Make sure the floor of the kiln and the tops of the shelves are coated with kiln wash. Kiln wash will keep running glaze from ruining a kiln shelf or the floor of the kiln. (Do not coat the undersides or the sides of the shelves because you do not want the kiln wash to fall off into the kiln).
4. Keep a kiln log of firings. Tracking the performance of your kiln over time may turn out to be an extremely valuable tool if you ever need to diagnose future problems.

## AFTER 10 FIRINGS

1. Check temperatures of the power lead at the receptacle while the kiln is at its hottest. If these are hotter than normal, it could be a sign of a loose or corroded connection, or possibly the wire gauge used in the power hook-up is the wrong size for the amount of current being drawn by the kiln. Immediately diagnose and fix this because it could cause a fire.
2. Check plug for oxidation or any burn marks, discoloration or melted spots. If you see this replace the plug (and possibly the receptacle) before using the kiln again. Make sure the receptacle feels tight when you press the plug into the outlet. A loose receptacle indicates worn springs, which will lead to overheating. NOTE: you can put an oxidation inhibitor on the prongs.
3. Repair any firebrick problems.



## **EASY-FIRE KILN INSTRUCTIONS (EUROPEAN VERSION) WITH DYNATROL 700**

### **AFTER 30 FIRINGS OR ANNUALLY**

1. Check element resistance. You will need a digital multimeter (see the Troubleshooting Guide). Keep track of this information.
2. Check tightness of case and retighten if necessary. (the case will expand and contract during each firing and may eventually become loose. Brick also shrinks slightly with use - especially if used at the higher temperatures like cone 10).
3. Check internal wires for deterioration or oxidation. Replace any that seem brittle or where the wire insulation has deteriorated or fallen off. Check terminals for oxidation (discoloration). If you are near salt air or if you notice corrosion on the stainless exterior of the kiln for whatever reason (like certain fumes generated by your work) then do this far more frequently.
4. Check power connection terminals in the kiln and control box for tightness. Be sure to do this with the kiln unplugged. If these terminal connections get loose heat can be generated and this can cause a fire.
5. Check thermocouple connections for corrosion, tightness and oxidation as well. A bad thermocouple connection can change the accuracy of the temperature reading, which could cause an overfiring.

When replacing electrical components, replace the electrical connectors. At the very least check for discoloration (an indication of oxidation).

### **CHECK THERMOCOUPLE CALIBRATION**

Thermocouples will drift in reading over time. This could potentially lead to an overfiring before the thermocouple actually fails. Although you cannot easily check thermocouple calibration, the general accuracy of the entire kiln system can be checked by firing with witness cones.



## HARD CERAMIC ELEMENT HOLDERS



DYNATROL  
REFERENCE

- A Unique Feature on All L&L Kilns. Protects interior firebrick from cracked and broken routed element channels.
- No pins required to hold elements in place.
- Improves firing efficiency - hot elements are not insulated from the interior of the kiln by insulating firebrick. There is only 4.75mm (3/16") of dense non-insulating ceramic separating the hot element from the kiln interior.
- Kilns are easier to repair - much easier to change elements with less chance of damaging kiln.

***IT'S WHAT MAKES L&L KILNS UNIQUE***



**FOR 60 YEARS... THE KILN TECHNOLOGY LEADER**  
L&L Kiln Mfg Inc. ♦ 8 Creek Parkway ♦ P.O. Box 1898 ♦ Boothwyn, PA 19061  
Phone: (610)485-1789 ♦ Fax: (610) 485-4665 ♦ Email:sales@hotkilns.com ♦ Web:www.hotkilns.com

---

## **DYNATROL REFERENCE INSTRUCTIONS** **With the 700 Series Processor**

***Congratulations!*** You have just purchased one of the new DynaTrol automatic temperature controls with “Dynamic Zone Control”. This is an easy to use control which should give you many years of service.

**Suggestions? Firing Tips? Corrections?** Please phone, fax or email us with your suggestions, firing tips, unique uses, applications, or corrections. The DynaTrol is a truly great control. However, we want to keep improving both the control and the instructions. Please help us and our other customers.

**What Control this manual applies to:** This manual is for all DynaTrols with the 700 Series processor. These are used in most kilns manufactured after Jan 1, 2005.

**Note:** One easy way to tell whether you have a 700 level control is to look at the display. Each of the four characters on the display have 14 segments in the character, allowing a for a more legible display. The older controls had 7 lighted segments in each character.

### **TYPE CONVENTIONS USED IN THIS MANUAL**

**BUTTON** = This type font equals a button that you hit on the face of the control

**DISPLAY** = This type font equals what the display shows

**TABLE OF CONTENTS**

|   |           |
|---|-----------|
| <b>TABLE OF CONTENTS</b>  | <b>1</b>  |
| <b>CONTROL PRECAUTIONS</b>  | <b>5</b>  |
| NOTE: SETTING UP THE SECTIONS WITH A JUPITER OR DAVINCI KILN                                | 6         |
| <b>DYNATROL SPECIFICATIONS</b>  | <b>6</b>  |
| <b>OVERVIEW: HOW THE DYNATROL WORKS</b>   | <b>6</b>  |
| WHEN YOU HAVE LESS THAN THREE THERMOCOUPLES   | 7         |
| <b>PROGRAMMING</b>  | <b>7</b>  |
| <b>4.1 EASY-FIRE</b>  | <b>7</b>  |
| 4.1.1 To use EASY-FIRE:   | 8         |
| 4.1.2 EASY-FIRE Example 1   | 10        |
| 4.1.3 EASY-FIRE Example 2   | 11        |
| 4.1.4 EASY-FIRE OPTIONS SECTION   | 12        |
| 4.1.4.1 Delay Button  | 12        |
| 4.1.4.2 Preheat Button  | 12        |
| 4.1.4.3 Alarm Button  | 13        |
| 4.1.4.4 Downramping, or Controlled Cooling with EASY-FIRE                                   | 13        |
| 4.1.5 EASY-FIRE Example 3 with a controlled cooldown  | 14        |
| <b>4.2 VARY-FIRE</b>  | <b>16</b> |
| 4.2.1 VARY-FIRE Example   | 17        |
| NOTE: Preheating (Candling) with VARY-FIRE  | 18        |
| 4.2.2 Downramping, or Controlled Cooling with VARY-FIRE                                     | 18        |
| 4.2.3 Using VARY-FIRE to fire to a CONE number  | 19        |
| Example: (Same program as the earlier example, just going to a cone number instead of 1575) | 19        |
| 4.2.4 Adding Two VARY-FIRE Programs Together  | 20        |
| 4.2.5 The UNDO/GO-BACK Button   | 21        |
| 4.2.6 The RECALL PROG (RECALL PROGRAM) Button   | 21        |
| 4.2.7 The SKIP-STEP Feature   | 21        |
| <b>4.3 VIEW/ REVIEW AND SPECIAL OPTIONS</b>   | <b>22</b> |
| 4.3.1 Review Prog (Review Program)  | 22        |
| 4.3.2 Review Seg (Review Segment)   | 23        |
| 4.3.3 The 'Other' Button  | 24        |
| When you press Other this is what you see:  | 24        |
| 4.3.3.1 Reset   | 24        |
| 4.3.3.2 Cone Lookup Table   | 24        |
| 4.3.3.3 Identification  | 25        |
| 4.3.3.4 Sixteen Segment Program   | 25        |
| 4.3.3.5 Cone Offset   | 25        |
| 4.3.3.6 Change from Deg F to Deg C  | 27        |
| 4.3.3.7 Error Codes (On/Off)  | 27        |
| 4.3.3.8 Thermocouple Offsets  | 27        |
| 4.3.3.9 Board Temperature   | 28        |
| <b>4.4 HIDDEN "Other" MENU &amp; Programming the Powered Bottom</b>                         | <b>29</b> |
| 4.4.1 NOTC: Number of Thermocouples   | 29        |
| 4.4.2 OP A: Option A  | 30        |
| 4.4.3 OP B: Option B  | 30        |
| 4.4.4 OP C: Option C  | 30        |
| 4.4.5 PCT; Percent  | 30        |
| 4.4.6 Pid: PID Setting  | 30        |
| 4.4.7 dIAG: Diagnostics   | 30        |
| 4.4.8 ShTO: Shut-OffAveraging   | 31        |
| 4.4.9 ALR4: Alarm For...  | 31        |

# DYNATROL REFERANCE MANUAL (Blue 700- Rev 5.0)

|   |           |
|---|-----------|
| 4.4.10 CYCL; Cycle Time   | 31        |
| 4.4.11 MAX; Max Temp Setting  | 31        |
| 4.4.12 TYPE; Type of Thermocouple   | 31        |
| 4.4.13 2KEY; Two- Key Start   | 32        |
| 4.4.14 E-bd; Error Board Temperature  | 32        |
| 4.4.15 REST; Restore Default USER Programs  | 32        |
| 4.4.16 ERTF; Stores the Temp, Hours Past, and Rate of Rise when an Error Code occurs. | 32        |
| 4.4.17 COOL; Cone-Fire Cooling Segment  | 32        |
| 4.4.18 VOLT; Voltage Measurement  | 33        |
| 4.4.19 DTCT; Amperage Measurement Setting   | 33        |
| 4.4.20 Amperage Measurement   | 34        |
| <b>APPENDIX A</b>   | <b>34</b> |
| <b>OVERVIEW OF FEATURES</b>   | <b>34</b> |
| A.1 Dynamic Zone Control  | 34        |
| A.2 Programmable Number of Zones  | 34        |
| A.3 Four Easy Preset Programs   | 35        |
| A.4 Six User Defined Programs   | 35        |
| A.5 Linkable Programs   | 35        |
| A.6 Delay Start   | 35        |
| A.7 Preheat (Candling)  | 35        |
| A.8 Soak  | 36        |
| A.9 Audible Temperature Alarm   | 36        |
| A.10 Program Review   | 36        |
| A.11 Segment Review   | 36        |
| A.12 Skip Segment   | 36        |
| A.13 Set Point Indication   | 36        |
| A.14 Change of Program During Firing  | 36        |
| A.15 Cone Offset  | 37        |
| A.16 Thermocouple Offset  | 37        |
| A.17 Last Temperature Reached Indication  | 37        |
| A.18 Cone/Temperature Equivalent Look Up Table  | 37        |
| A.19 Dust Sealed Keypad   | 37        |
| A.20 Easy to Follow Graphic Design  | 38        |
| A.21 Error Checking Can Be Turned Off   | 38        |
| A.22 Reset Defaults Function  | 38        |
| A.23 Reads Control Board Temperature  | 38        |
| A.24 Automatic Restart after Brief Power Interruption with Flashing Alert             | 38        |
| A.25 PID Tuning Control   | 38        |
| A.26 Thermocouple Burnout Protection  | 38        |
| A.27 Digital Indication of Temperature in either Degrees F or C                       | 38        |
| A.28 See All the Zone Temperatures  | 39        |
| A.29 See Which Zones are Firing   | 39        |
| A.32 Cold Junction Compensation   | 39        |
| A.33 Matches Pyrometric Cone Performance in EASY-FIRE Mode                            | 39        |
| A.35 Computer Interface System  | 39        |
| <b>APPENDIX B</b>   | <b>42</b> |
| <b>DESCRIPTION OF KEY FUNCTIONS AND DISPLAY</b>                                       | <b>42</b> |
| B.1 START/STOP Key  | 43        |
| B.2 VARY-FIRE PROGRAMMING Section   | 43        |
| B. 3 LED DISPLAY- Displays temperatures, times, and messages.                         | 43        |
| B.4 REVIEW & SPECIAL OPTIONS  | 44        |
| B.5 NUMBER KEYS Section   | 45        |
| B.6 EASY-FIRE Section   | 45        |
| B.7 EASY-OPTIONS Section  | 46        |

# DYNATROL REFERENCE MANUAL (Blue 700- Rev 5.0)

|   |           |
|---|-----------|
| <b>APPENDIX C</b>   | <b>46</b> |
| TERMS AND ABBREVIATIONS   | 46        |
| <b>APPENDIX D DISPLAY MESSAGES (in alphabetical order)</b>  | <b>48</b> |
| <b>APPENDIX E EASY-FIRE TEMPERATURE PROFILES</b>  | <b>52</b> |
| <b>APPENDIX G ERROR CODES</b>   | <b>57</b> |
| <b>APPENDIX H</b>   | <b>59</b> |
| H.1 During programming of a firing, I typed a wrong number. How do I correct this?  | 59        |
| H.2 How do I clear the ERRP/ PF from the display?   | 59        |
| H.3 I am getting the E d message. What is wrong?  | 59        |
| H.4 I am getting the E l message. What is wrong?  | 59        |
| H.5 My kiln takes longer to fire than I think it should.  | 60        |
| H.6 My program takes longer to complete than I expected. What is happening?   | 60        |
| H.7 My kiln seems to be much hotter than the thermocouples indicate. Or the kiln seems to be going to slow (by the readings on the controller).               | 60        |
| H.8 Is there a guaranteed soak?   | 60        |
| H.9 I turned on the controller and FAIL is displayed. What does this mean?  | 60        |
| H.10 I keep burning out thermocouples. What is wrong?   | 61        |
| H.11 How can I find out the final temperature which was reached during a cone firing?   | 61        |
| H.12 My kiln underfires, turns off before the DynaTrol reaches its set point .  | 61        |
| H.13 Why use a soak time or make the kiln go slow?  | 61        |
| H.14 Can you change a program segment while running a program?  | 61        |
| H.15 When the control flashes TC2 alternating with a temperature does it read that until you toggle to a different thermocouple?                              | 62        |
| H.16 Is there a lead zone?  | 62        |
| H.17 Is this a time proportioning control?  | 62        |
| H.18 What happens when I turn off the Error Codes?  | 62        |
| H.19 What happens when a thermocouple fails?  | 62        |
| I.20 One or more of the thermocouples reads FAIL. What is wrong?  | 62        |
| H.21 What is PID and can the PID settings be changed?   | 63        |
| H.22 Is there any way to know what the set point actually is?   | 63        |
| H.23 What happens if there is a power outage?   | 63        |
| H.24 The display is jumpy. What about Thermocouple noise?   | 63        |
| H.25 Do thermocouples need to be grounded or ungrounded?  | 63        |
| H.26 Can I override the end of a firing to gain temperature?  | 63        |
| H.27 I hear the contactors clicking on and off when the kiln is at a low temperature and even though my set point is way above the temperature readings. Why? | 64        |
| H.28 What does it mean when the display flashes?  | 64        |
| H.29 What does CPL mean?  | 64        |
| H.30 How do you turn off the audible alarm?   | 64        |
| H.31 How do I get information about my firing?  | 64        |
| H.32 What ambient temperature conditions do I need for the control?   | 64        |
| H.33 The kiln did not begin soaking when it should have.  | 64        |
| H. 34 The thermocouples seem to be off according to the cones.  | 64        |
| H.35 How do I ramp down?  | 65        |
| H.36 Does the control work on 50 HZ?  | 65        |
| H.37 TEMPERATURE READINGS VS CONES  | 65        |
| <b>APPENDIX I</b>   | <b>66</b> |
| VARY-FIRE DEFAULT PROGRAM'S TEMPERATURE PROFILES  | 66        |
| <b>APPENDIX J FIRING PROGRAM BLANK</b>  | <b>68</b> |

## **1.0 CONTROL PRECAUTIONS**

- The controller is used to control temperature, it is not a safety device.
- Do not operate the controller in temperatures above 125°F or below 32°F (NOTE: The board components are rated for 50°C below zero so the control (and kiln) can be stored outside in a covered area).
- Never leave your kiln unattended at the end of a firing. (The Delay feature gives you control over this).
- The controller contains electronic components which are sensitive to static electricity. Before handling the controller dissipate any static charge you may have by touching metal or a screw on the controller panel, the electrical box, the kiln lid, or some other grounded object. Pack in anti-static treated material or paper. Do not pack in plastic bag or untreated material.
- Be sure that the kiln has been set up properly. For EASY-FIRE kilns see the specific EASY-FIRE Assembly Instructions. For Davinci and Jupiter kilns: the kiln sections are numbered with a small sticker on the end of each section's powercord. The top section on any L&L kiln is section #1. The #2 section is always the section directly under the #1 section on any sectional L&L kiln. On three section kilns section #3 is the bottom section. On kilns with more than three sections, sections are numbered 1 through 4 or 1 through 5, top to bottom. Likewise, the top thermocouple is labled #1 and should be in the top section of the kiln. The #2 thermocouple is the bottom thermocouple in a two section kiln. The #2 thermocouple is the middle thermocouple on three or more section kilns. The #3 thermocouple is always in the bottom section of the kiln. It is imperative that your kiln is set up like this. Be sure to double-check this even if you set up the kiln yourself.
- When hooking up the thermocouple wires to the thermocouples on the kiln be sure to follow these color codes:

### **THERMOCOUPLE WIRE COLOR CODING**

**In the USA and non-European countries with Type K Thermocouples:** The RED wire goes to the NEGATIVE side of the thermocouple connection block and the YELLOW wire goes to the POSITIVE side of the thermocouple connection block. The external sheathing of the extension wire is YELLOW.

**In the USA and non-European countries with Type S Platinum Thermocouples:** The RED wire goes to the NEGATIVE side of the thermocouple connection block and the BLACK wire goes to the POSITIVE side of the thermocouple connection block. The external sheathing of the extension wire is GREEN.

**In European Countries with Type K Thermocouples:** The WHITE wire goes to the NEGATIVE side of the thermocouple connection block and the GREEN wire goes to the POSITIVE side of the thermocouple connection block. The external sheathing of the extension wire is GREEN.

**In European Countries with Type S Platinum Thermocouples:** The WHITE wire goes to the NEGATIVE side of the thermocouple connection block and the ORANGE wire goes to the POSITIVE side of the thermocouple connection block. The external sheathing of the extension wire is ORANGE.

**NOTE:** On the 700 control the control can be switched between Type K and Type S. This requires a software configuration as well as a jumper change. See more about this is section 4.4.12.



## DYNATROL REFERANCE MANUAL (Blue 700- Rev 5.0)

- Always check the position of the thermocouple probe on the inside of the kiln before starting a firing. The current temperature displayed on the controller is measured at the end of the thermocouple. NOTE: If the thermocouple tip (where the temperature is measured) is back inside the brick insulation of the kiln (even a little bit) it will make the control think that the kiln is not as hot as it really is. That could lead to an overfiring!
- Always review the current program before firing to ensure the correct profile is programmed.
- We recommend having your kiln shut off by a manual fused disconnect switch located near the kiln. That way you can turn off all electricity to the kiln when you are not using it. This would prevent any sort of accidental turning on of the kiln by an electrical surge.
- Follow the other precautions listed in your Kiln Instructions and in the Troubleshooting Guide.



### **NOTE: SETTING UP THE SECTIONS WITH A JUPITER OR DAVINCI KILN**

Be sure to set up the sections, thermocouples and plugs in the proper way or the kiln will not work properly.

## **2.0 DYNATROL SPECIFICATIONS**

**Thermocouple Input:** Type K or Type S (software/jumper switchable)

**Accuracy:** +/- 10°F

**Cold Junction Compensation:** Electronic

**Power Input:** 24 Volt Center Tap Transformer / 50 Hz or 60 Hz

**Outputs 1 & 3:** 150mA at 12 VDC, one 12 volt relay with 80 ohm coil per output

**Output 2:** 600mA at 12 VDC, one to three 12 volt relays with 80 ohm coil per output

**Output 4:** 150mA at 12 VDC, one optional 12 VDC relay with 80 ohm coil per output

**Output 5:** 150mA at 12 VDC, one optional 12 VDC relay with 80 ohm coil per output

**Operating Temperature Range:** 0°F to 125°F, 0°C to 52°C (See the notes in the Frequently Asked Questions Section concerning “What Ambient Temperature Conditions do I need for control?”)

**High Side Switching:** High side switching which allows the relay’s return wire to be connected to ground (if the return wire shorts to ground it will have no effect).

**Safety Transistor:** A safety transistor powers the other output transistors giving multiple ways to turn off the output and increase safety.

**Capacitor-Couple Output:** The microprocessor is connected to the output transistor through a capacitor so that the output turns off if the microprocessor latches up.

## **3.0 OVERVIEW: HOW THE DYNATROL WORKS**

When electrical power is connected to the Dynatrol, the display will be lit, and **WAIT** will be displayed for about 5 seconds then, **IdLE**, **TC2**, and the current temperature will be cycling over and over in the display. This cycling **IdLE** message means that the Dynatrol is on, ready to be programmed, but the kiln is not running yet. The current temperature is measured at the tip of the three thermocouples (**TC1**, **TC2**, **TC3**). If the thermocouple wires are connected to the thermocouples and if the tips of the thermocouples are inserted inside the kiln, the current temperature displayed is the temperature inside the kiln. The default thermocouple reading is **TC2**. In other words unless you specifically ask the control to show you the temperature at **TC1** or **TC3** then it will only show you the temperature at **TC2**. This is done by simply pressing the #1 button to see the temperature at **TC1**, or the #3 button to see the temperature at **TC3**.

When the **START/STOP** button is pressed after either a EASY-FIRE (also sometimes called “Cone-Fire) or a VARY-FIRE profile has been selected, the Dynatrol starts to increase the temperature in the kiln towards the first set temperature at the programmed rate of rise. The kiln

## DYNATROL REFERANCE MANUAL (Blue 700- Rev 5.0)

will be cycling (clicking) on and off to accomplish the exact rate of temperature rise. When the displayed temperature reaches the first set temperature in the first segment, the first hold phase can begin. If there is a hold time programmed in this segment, the Dynatrol will hold at the first set temperature for the programmed amount of hold time until the ending of the first segment of the firing. The second segment ramp stage then begins with the temperature increasing toward the second set temperature at the second ramp rate. Once it reaches the second set temperature it will hold there if there is a hold time programmed for the second segment (if there is no hold time then it simply goes on to the next segment). The control keeps going through this sequence until the end of the firing profile.

With the VARY-FIRE mode you may program six different programs with up to eight segments in each program. VARY-FIRE programs can be changed to whatever you need them to be. Each segment in a given program has a ramp rate (set in degrees Fahrenheit or Centigrade, heating or cooling, per hour), a set point temperature or cone number (the temperature that ramp rate will heat or cool to) and an optional hold time at that temperature for up to 99 hours and 99 minutes. In the “EASY-FIRE” mode, the number of segments and the firing profile are preset according to the EASY-FIRE Temperature Profiles shown in the Appendix section. The ramp portion of a segment need not always be increasing in temperature. You can program a decrease in temperature at a specific rate also. EASY-FIRE programs can have preheat segments and cooling segments added to them, or they can stand alone.



### WHEN YOU HAVE LESS THAN THREE THERMOCOUPLES

If your kiln has only two thermocouples you will not be able to find **TC3** as there is no third thermocouple. The Dynatrol comes pre-programmed from the factory for your kiln's particular specifications.

If your kiln only has one thermocouple many of the features in the Dynatrol are not used. Rather than seeing **IdLE** and a **TC1**, **TC2**, or **TC3**, you will only see **IdLE** and a temperature flashing on and off. Likewise any menu choice which controls relationships between the different “zones” in the kiln will either not even appear in the menu or if in the menu or will not affect the Dynatrol's operation using only one thermocouple.

## 4.0 PROGRAMMING

### 4.1 EASY-FIRE

The EASY-FIRE mode allows you to fire to a CONE NUMBER at one of four different speeds and then hold at that final temperature if you desire. EASY-FIRE also allows you to add a preheat time to the beginning of the program, and/or, a slower cooling time or a more complex program to the end of it. These are the four preset EASY-FIRE programs that have been designed to do most typical ceramic firing cycles. They are **Slow Bisque** (very slow; approximately 13+ hours heating time only), **Fast Bisque** (slow; approximately 10+ hours heating time only), **Slow Glaze** (medium; approximately 6-1/2+ hours heating time only) and **Fast Glaze** (fast; approximately 3+ hours heating time only). These preset programs have specific ramps and speeds built into them. You can enter any cone number up to cone 10. \*(see note below) as the hottest set point. This allows for some degree of customization while still keeping the programming simple and easy.

The EASY-FIRE mode uses the Orton Foundation's patented method to achieve the correct heat work making these programs ideal for firing ceramics. The advantage of using the EASY-FIRE method is that a very complicated firing profile may be chosen with just a few key strokes (see Appendix F for these firing profiles). These program's final temperature set points are based on a

# DYNATROL REFERANCE MANUAL (Blue 700- Rev 5.0)

108°F temperature rise per hour for a large Orton self-supporting cone (rather than the small Orton cones or regular large Orton cones). Your real rate of climb may be different in the end; depending on a lot of different variables. **Expect to see a lower final temp if the kiln goes slower, or a higher one if it climbs faster.**



\* **NOTE:** Some L&L Kilns are not designed to go to cone 10 or 2350°F. Consult your kiln's control panel label for the maximum operating temperature.

## 4.1.1 To use EASY-FIRE:

|   |
|---|
| Make sure <b>IdLE</b> , <b>tC2</b> , and the temperature are flashing.  |
| Press one of the four easy firing profile buttons: <b>SLOW BISQUE</b> or <b>FAST BISQUE</b> or <b>SLOW GLAZE</b> or <b>FAST GLAZE</b> .   |
| Press <b>ENTER</b> . You will see <b>S-bC</b> , <b>F-bC</b> , <b>S-GL</b> or <b>F-GL</b>  |
| Type the cone number you want to fire to (for instance <b>05</b> ).   |
| If you type a wrong number here, press <b>000</b> until all zeros appear in the display, press <b>ENTER</b> , then type the correct cone number.  |
| Press <b>ENTER</b> .  |
| Type the hold time or leave at <b>0.00</b> . Numbers to the left of the decimal are hours, to the right are minutes. (Note that adding hold time will add heat-work to ceramics and thus increase the cone that you are firing to. The EASY-FIRE programs will NOT compensate for this) |
| Press <b>ENTER</b> , <b>IdLE</b> , <b>tC2</b> and the current temperature will be flashing in the display.  |
| Press <b>START/STOP</b> to begin firing.  |

### 4.1.1.1 Use the Preheat Option:



**NOTE: PREHEAT OPTION.** With any of the EASY-FIRE programs, a preheat stage is available. During the preheat stage the temperature is automatically increased at a rate of 60°F per hour until 200°F is reached; the 200°F temperature is then held for the programmed amount of time. Preheat is automatically set to zero at the end of each firing, so if a preheat stage is wanted, it must be reprogrammed for each EASY-FIRE firing.

|  |
|--|
| To preheat the kiln for a specific amount of time you must first program an EASY-FIRE program. Once this is done you can add the preheat option to it:   |
| Press <b>PREHEAT</b> and see <b>HLd, 0.00</b> cycling over and over.   |
| Press the number keys to enter the amount of Preheat time desired. Numbers to the LEFT of the decimal in the display are hours, i.e. 3 hours of preheat time would look like <b>03.00</b> or like <b>3.00</b> . Numbers to the RIGHT of the decimal in the display are minutes, i.e. 75 minutes of preheat time would look like <b>00.75</b> or like <b>0.75</b> . |
| Press <b>ENTER</b> and see <b>CPL</b> meaning that programming the preheat option is complete.   |

**More Information about Preheat -see Section 4.1.4.1**

### 4.1.1.2 Use the Delay Option:



**NOTE: DELAY OPTION** With any EASY-FIRE or VARY-FIRE program an optional Delay for the start time of the program is available. **This feature makes it easy for you to be present at the end of a firing.** Appendix F has the estimated times that the EASY-FIRE Programs take for selected cone numbers. By using this appendix, and adding however many hours you need, up to 99 hours and 99 minutes, to the delay timer you can ensure your presence at the end of the firing.

## DYNATROL REFERANCE MANUAL (Blue 700- Rev 5.0)

To program a delay time you need not have programmed any firing profile yet. When the display cycles **IdLE**, **tC2**, current temperature over and over:

|   |
|---|
| Press <b>Delay</b> and see <b>dELA, 0.00</b> cycling over and over. |
|---|

|   |
|---|
| Press the number keys to enter the amount of delay time desired. Numbers to the RIGHT of the decimal in the display are minutes, i.e. 75 minutes of delay time would look like <b>00.75</b> or <b>0.75</b> or <b>.75</b> . Numbers to the Left of the decimal in the display are hours, i.e. 14 hours 30 minutes of delay time would look like <b>14.30</b> . |
|---|

|   |
|---|
| Press <b>ENTER</b> and see <b>IdLE/ TC 2</b> , - that's it. |
|---|

Now once you program any EASY-FIRE or VARY-FIRE program this delay will appear in the display like a timer counting down when you press **START/STOP** to begin firing. The firing will begin once the timer reaches zero. It will remain set as is until you change it.

**More Information about Delay - see Section 4.1.4.2**

### 4.1.1.3 Controlled Cooldown:



**NOTE: DOWN-RAMP or EXTENDED FIRING OPTION.** With any EASY-FIRE program an optional controlled cooling or extended firing can be added. This allows you to control the cooling rate of your firing if you want to, or add as many as seven more segments to the program for crystalline firing (or other slow cooling effects). The DynaTrol comes pre-programmed with a slow cooling program you can add to a cone 6 program. The pre-programmed cooldown is located under **USER 6** in the VARY-FIRE programs. **USER 6** is the only program that can be added to an EASY-FIRE program

The pre-programmed cone 6 cooldown can be reprogrammed with a different program. Once this happens the cone 6 cooldown program will no longer be available until you re-enter it or until the control's defaults are reset.

**To Add The Program That Is In User 6 to an EASY-FIRE Program:**

|   |
|---|
| When the display cycles <b>IdLE</b> , <b>TC2</b> , current temperature over and over: |
|---|

|  |
|--|
| First enter a complete <b>EASY-FIRE</b> program. |
|--|

|  |
|--|
| Once it says <b>IdLE</b> , <b>TC2</b> again, press <b>Other</b> again and again until it shows <b>16-S</b> , then press <b>ENTER</b> |
|--|

|  |
|--|
| Press <b>1</b> until it says <b>ON</b> , press <b>ENTER</b> and see <b>IdLE</b> , <b>TC 2</b> , current temperature over and over: |
|--|

Setting the **16-S** setting to **ON** will attach whatever is in **USER 6** to the last EASY-FIRE program you programmed. Setting the **16-S** to **OFF** will unattach **USER 6** from your EASY-FIRE program. To change this program see the VARY-FIRE section a little further on in this section of the kiln manual.

**More Information about Down-ramping and Adding Segments - see Section 4.1.4.4**



**NOTE:** If you make a mistake while programming (like entering the wrong hold time) and you have already pressed **ENTER**, You must complete the programming as if you made no mistake, to get back to **IdLE**, **TC2**, and the current temp again. Then you must re-enter the entire program over again, making sure that you do it properly this time.

## DYNATROL REFERENCE MANUAL (Blue 700- Rev 5.0)

### 4.1.2 EASY-FIRE Example 1

**Slow Bisque Firing Profile to Cone 04, Pre-heat of 1 hour, 2 minute Hold** - Use the following steps for a bisque firing to cone 04, a 2 minute temperature hold at the peak temperature, and a preheat stage with 1 hour hold time. **THIS IS JUST AN EXAMPLE...** You can change the firing profile, cone number, hold time, or preheat time to fit your specific needs.

To begin programming the display must be reading **IdLE**, **TC2**, and the current temperature.

| Press              | Display   | Comment  |
|--------------------|---|--|
| <b>Slow Bisque</b> | <b>S-bC</b>   | If you press the wrong button, before pressing <b>ENTER</b> , simply press the correct button.   |
| <b>ENTER</b>       | Alternately flashing:<br><b>CONE &amp; #</b>              | The Slow Bisque profile is now selected. The word <b>CONE</b> and the last entered cone number will alternately flash on the display. Now enter the cone number - <b>04</b> .  |
| <b>04</b>          | Alternately flashing:<br><b>CONE &amp; 04</b>             | The word <b>CONE</b> and the entered cone number will alternately flash on the display. If you type a wrong number, press <b>000</b> , then type the correct number.   |
| <b>ENTER</b>       | Alternately flashing:<br><b>HOLD &amp; 0.00</b>           | The cone number has been accepted. Now enter the 10 minute hold time.  |
| <b>0002</b>        | <b>00.02</b>  | Numbers to left of decimal point are hours, to the right of decimal point are minutes. If you type a wrong number, press <b>0000</b> , then type the correct number.   |
| <b>ENTER</b>       | <b>IdLE TC 2</b> flashes,<br>then the current temperature | The 2 minute hold time is accepted. <b>IdLE</b> indicates the firing profile has been completed.   |
| <b>Preheat</b>     | Alternating flashing:<br><b>HLd &amp; 0.00</b>            | Preheat has been selected and the hold time is to be entered now.  |
| <b>100</b>         | <b>1.00</b>   | Numbers to left of decimal point are hours, to the right of decimal point are minutes. NOTE: For a 1 hour hold time you could also enter <b>60</b> for 60 minutes; the display would show <b>.60</b> . If you type a wrong number, press <b>0000</b> , then type the correct number.   |
| <b>ENTER</b>       | <b>IDLE TC 2</b> flashes,<br>then current temperature     | Accepts a hold time of 1 hour, then <b>IdLE</b> indicates the preheat stage has been completed.  |
| <b>START STOP</b>  | <b>-0N-</b>   | After <b>-0n-</b> is displayed for several seconds, the heating elements of the kiln will cycle on and the current temperature in the kiln will be displayed. If a time is displayed instead of the current temperature, then a delay start is in effect. If you do not want to delay the start. Press <b>START/STOP</b> button, then <b>DELAY</b> , then <b>0000</b> , then <b>ENTER</b> . When the current temperature and <b>IdLE</b> are again flashing in the display, press <b>START/STOP</b> to re-start the program. |

## DYNATROL REFERANCE MANUAL (Blue 700- Rev 5.0)

### 4.1.3 EASY-FIRE Example 2

**Fast Glaze Firing Profile to Cone 06, 10 minute Hold, Delay start of 2 hours.** Use the following steps for a glaze firing to cone 06, a 10-minute temperature hold at the peak temperature, and a 2-hour delay before the start of the firing. **THIS IS JUST AN EXAMPLE.** You may change the firing profile, cone number, hold time, delay time, or even add a preheat to this program to fit your special needs.

| Press                  | Display   | Comment  |
|------------------------|---|--|
| <b>Fast Glaze</b>      | <b>F-GL</b>   | If you press the wrong button, before pressing <b>ENTER</b> , simply press the correct button.   |
| <b>ENTER</b>           | Alternately flashing:<br><b>CONE &amp; #</b>  | Fast Glaze is selected. The word <b>CONE</b> and the last entered cone number will alternately flash on the display.   |
| <b>06</b>              | Alternately flashing:<br><b>CONE &amp; 06</b>   | The word <b>CONE</b> and the entered cone number will alternately flash on the display. If you type a wrong number, press <b>0000</b> , then type the correct number.                            |
| <b>ENTER</b>           | Alternately flashing:<br><b>HOLD &amp; 0.00</b>   | The cone number has been accepted and the hold time is entered now.  |
| <b>10</b>              | <b>00.10</b>  | The Hold time is displayed. Numbers to left of decimal point are hours, to the right of decimal point are minutes. If you type a wrong number, press zero 4 times, then type the correct number. |
| <b>ENTER</b>           | <b>IDLE TC 2</b> flashes,<br>then the current temperature                                 | Accepts a hold time of 10 minutes and then <b>IdLE</b> indicates the firing profile has been completed.  |
| <b>Delay</b>           | Alternately flashing:<br><b>dELA &amp; 0.00</b> (or the<br>last programmed delay<br>time) | Either <b>0.00</b> or the last programmed delay time will flash alternately with <b>dELA</b> .   |
| <b>200</b>             | <b>02.00</b>  | Numbers to left of decimal point are hours, to the right of decimal point are minutes. If you type a wrong number, press zero 4 times, then type the correct number.                             |
| <b>ENTER</b>           | <b>IdLE TC 2</b> flashes,<br>then current temperature                                     | The 2 hour delay time is accepted. <b>IdLE</b> indicates the job is completed.   |
| <b>START/<br/>STOP</b> | <b>-0n-</b> then <b>2.00</b>  | Starts the countdown of the delay time toward zero, at which time the kiln will start to heat. The display will show the amount of time left until the firing is to start.                       |

## 4.1.4 EASY-FIRE OPTIONS SECTION

### 4.1.4.1 Delay Button

This button's function is used to delay the start of a firing.



**NOTE:** There is a separate button specifically for this function. If you program a delay start it will remain on and set for all programs (both VARY-FIRE and EASY-FIRE until you take it off by programming it to **0.00**. This means you can program the delay time before or after you enter (or recall) the program that you want to fire.

**Example:** Program a one hour delay to the start of a firing. You can change the one hour delay to as much as 99 hours and 99 minutes of delay time.

**Remember:** **IdLE**, **TC2**, and the current temperature must be cycling on the display before beginning to program.

| Press        | Display   | Comment  |
|--------------|---|--|
| <b>Delay</b> | Alternately flashing:<br><b>dELA</b> and <b>0.00</b>        | The controller is ready to accept the delay time of 1 hour.  |
| <b>100</b>   | <b>1.00</b>   | Displays the selected time. Numbers to left of decimal point are hours, to the right of decimal point are minutes. If you type a wrong number, press <b>0000</b> , then type the correct number. |
| <b>ENTER</b> | <b>IdLE TC 2</b><br>flashes then the<br>current temperature | <b>IdLE</b> indicates the 1 hour delay has been accepted. The current temperature then flashes in the display.   |

### 4.1.4.2 Preheat Button

- Preheat can be used with the EASY-FIRE mode only. When Preheat is in use, the temperature ramps up at 60°F/hour to 200°F and then holds at 200°F for the amount of time programmed. If you start at a room temperature of 70°F, then it will take about 1-1/2 hours to reach 200°F at which time the hold segment in the Preheat will start. Preheat is automatically set to zero during EASY-FIRE programming and at the end of each firing, so if a preheat stage is wanted, it must be reprogrammed for each cone firing. **Preheat Example:** Set a preheat time of 3 hours.



**Remember:** You must choose and program an EASY-FIRE profile first, before you set the preheat time.

**IdLE**, **TC2** and the temperature must be flashing to start the programming.

| Press          | Display   | Comment   |
|----------------|---|---|
| <b>Preheat</b> | Alternately flashing:<br><b>HLd</b> and <b>0.00</b>         | If you see <b>IdLE</b> when you press Preheat then it means that you have a VARY-FIRE program entered. You can not use preheat with a VARY-FIRE program.  |
| <b>ENTER</b>   | Alternately flashing:<br><b>HLd &amp; 0.00</b>              | Preheat has been selected; enter the time you want to hold the temperature at 200°F (in this example 3 hours)   |
| <b>300</b>     | <b>3.00</b>   | Displays the selected time of 2 hours. Numbers to left of decimal point are hours, to the right of decimal point are minutes. If you type a wrong number, press <b>0000</b> , then type the correct number. |
| <b>ENTER</b>   | <b>IdLE TC 2</b><br>flashes then the<br>current temperature | <b>IdLE</b> , <b>TC2</b> , and the current temperature then cycles in the display.  |

**4.1.4.3 Alarm Button**

This button's function enables you to program an audible temperature alarm. (Note: it is not very loud)



**NOTE:** If the alarm is desired, it must be set with the Alarm Button for each firing when an EASY-FIRE program is chosen. When a VARY-FIRE program is chosen the Dynatrol will automatically use the alarm setting that can be programmed with that VARY-FIRE program (It is done within the VARY-FIRE program). Once the Alarm Button is pressed, if no alarm setting is entered within 10 seconds, the display will return to **IdLE TC 2** and the current temperature.

The alarm may be set before or *during* a firing. When the alarm temperature is reached, a beeper will sound. Turn off the sound by pressing **ENTER**. This is very useful for alerting you to specific critical temperatures in a program - for instance just before the kiln is going to reach maturing temperatures or when to close the peepholes during natural venting.

**Example:** Before or during a firing, set the alarm temperature to go off at 600°F.

| Press        | Display   | Comment  |
|--------------|---|--|
| <b>Alarm</b> | Alternately flashing:<br><b>ALRM</b> and #            | The word <b>ALRM</b> and the last entered alarm temperature will alternately flash on the display. The controller is ready to accept the alarm temperature. If no alarm is entered within 10 seconds, the display will return to <b>IdLE TC 2</b> and the current temperature. |
| <b>600</b>   | <b>600</b>  | Displays the selected temperature of 600°F. If you type a wrong number, press <b>0000</b> , then type the correct number.  |
| <b>ENTER</b> | <b>IdLE TC 2</b> flashes then the current temperature | The <b>IdLE, TC2</b> , and the current temperature then cycles in the display.   |

**4.1.4.4 Downramping, or Controlled Cooling with EASY-FIRE**

If your kiln is cooling too rapidly for good glaze results, or if the cooling is so rapid that cracking occurs on certain large pieces, it is recommended to cool under power. This is accomplished using the following instructions. A kiln with a light load or a large firing chamber will cool more quickly than a kiln with a heavy, dense load or a small firing chamber assuming the same thickness of the insulation. So you may want to test your kiln to see how quickly it cools at high temperatures and at low temperatures to see what type of cooling segment(s) you need.

The EASY-FIRE to VARY-FIRE feature allows you to fire an EASY-FIRE program and then automatically start a VARY-FIRE program at the end of the EASY-FIRE program.

**4.1.4.5 Step-By-Step: How To Control The Cooling**

- 1) First you enter the cooling segment. (NOTE: If your kiln is brand new this cooling segment is already entered in your DynaTrol. If you are not sure that it is in there, it will not hurt anything to re-enter it. Start by pressing the **ENTER PROG** button in the VARY-FIRE Section
- 2) Press **6** and then press **ENTER** to program **USER 6**.
- 3) Program **USER 6** with the desired cool down program. 150 degrees F per hour down to 1400 F is a good cooling program. Once we finish these steps, **USER 6** will start when your EASY-FIRE program reaches complete (**CPL T**). If you do not know how to program a VARY-FIRE program, see Section 4.2.



## DYNATROL REFERENCE MANUAL (Blue 700- Rev 5.0)

**NOTE:** Segment 1 of **USER 6** is utilized by the controller and cannot be used for the program. Therefore the number of segments you input for the program will need to be one greater than the number of segments that are really being used for the cooling. Once you begin programming **USER 6**; when the display asks for **RA 1** press **ENTER, ENTER, ENTER** and begin the cool-down part of the program with segment 2.

4) Press the desired EASY-FIRE program button (i.e. **Slow Bisque, Fast Bisque, Slow Glaze or Fast Glaze**).

5) Enter desired EASY-FIRE program. This will program the EASY-FIRE portion for the program. Do this just as you would for any EASY-FIRE program.

6) To tell it to join the cooling program to the EASY-FIRE program enter in the following: Press the **Other** button until **16-S** appears in the display. Press **ENTER**.

7) Press the **1** key until the desired condition is displayed. **On** will allow EASY-FIRE program to flow into VARY-FIRE **USER 6** program and **OFF** will disable this option.

8) Press the **ENTER** button. Programming is now complete. If 16-segment is **On** then the controller will complete the EASY-FIRE program and, upon finishing it, will run the VARY-FIRE **USER 6** program.

**NOTE:** **16-S** will appear in in the Program Review when you press the **Review Prog** button. Once the **USER 6** is programmed with the controlled cooling segment you do not need to enter it every time. In place of steps 1-3; do the following: 1) Press **Recall Prog**. 2) Press #6. 3) Press **ENTER**. Then follow with steps 4-8 above.

### 4.1.6 EASY-FIRE Example 3 with a controlled cooldown

Slow Glaze Firing Profile to Cone 6, 5 minute Hold, Controlled Cooldown.

| Press             | Display   | Comment   |
|-------------------|---|---|
| <b>Enter Prog</b> | Alternately flashing:<br><b>USER &amp; 6</b>                                  | This allows you to chose which program number to program. You <b>FIRST</b> have to program the cooldown program <b>BEFORE</b> you program the EASY-FIRE program. Otherwise the control thinks you are going to use VARY-FIRE program #6 as your main program. |
| <b>6</b>          | <b>6</b>  | You are going to program VARY-FIRE program No 6   |
| <b>ENTER</b>      | Alternately flashing:<br><b>SEGS &amp; 2</b><br>(or some other number<br>2-8) | This is the number of segments you will need. In most cases you will want 2 segments. The first segment <b>IS NOT USED</b> and it doesn't matter what it says.  |
| <b>2</b>          | <b>2</b>  | This tells the control you will be programming two segments   |
| <b>ENTER</b>      | Alternately flashing:<br><b>RA 1 &amp; 0500</b><br>(or some other number)     | This is the ramp of segment 1. It doesn't matter what the value is because it will be ignored.  |
| <b>ENTER</b>      | Alternately flashing:<br><b>OF 1 &amp; 0200</b><br>(or some other number)     | This is the temperature set point of segment 1. It doesn't matter what the value is because it will be ignored.   |
| <b>ENTER</b>      | Alternately flashing:<br><b>HLd1 &amp; 0200</b><br>(or some other number)     | This is hold value of segment 1. It doesn't matter what the value is because it will be ignored.  |

## DYNATROL REFERANCE MANUAL (Blue 700- Rev 5.0)

|                                   |   |  |
|-----------------------------------|---|--|
| <b>ENTER</b>                      | Alternately flashing:<br><b>RA 2 &amp; 0000</b><br>(or some other number) | This is asking you what ramp value to put in for segment 2. This will be our cooldown rate in degrees F (unless you are operating in deg C)  |
| <b>150</b>                        | <b>150</b>  | This means we will cool at a rate of 150 deg per hour.   |
| <b>ENTER</b>                      | Alternately flashing:<br><b>oF 2 &amp; 0000</b><br>(or some other number) | This is asking you what temperature value to put in for segment 2. This will be our cooldown setpoint, i.e. the target temperature to cool down to. After we reach this temperature the kiln will stop firing and it will cool down without any power. |
| <b>1400</b>                       | <b>1400</b>   | We will have a controlled cooldown to 1400 Deg F   |
| <b>ENTER</b>                      | Alternately flashing:<br><b>HLd2 &amp; 0000</b>                           | This is asking you for a hold time.  |
| <b>0000</b>                       | <b>00.00</b>  | Hold of zero   |
| <b>ENTER</b>                      | Alternately flashing:<br><b>ALRM &amp; 9999</b>                           | This is asking you for an alarm temperature. 9999 keeps it turned off.   |
| <b>ENTER</b>                      | <b>IdLE</b>   | The cooling segment is complete. Now we must enter the heating part of the program   |
| <b>Slow Glaze</b>                 | <b>S-GL</b>   | If you press the wrong button, before pressing <b>ENTER</b> , simply press the correct button.   |
| <b>ENTER</b>                      | Alternately flashing:<br><b>CONE &amp; #</b>                              | Fast Glaze is selected. The word <b>CONE</b> and the last entered cone number will alternately flash on the display.   |
| <b>6</b>                          | Alternately flashing:<br><b>CONE &amp; 6</b>                              | The word <b>CONE</b> and the entered cone number will alternately flash on the display. If you type a wrong number, press <b>0000</b> , <b>press ENTER</b> , then type the correct cone number.  |
| <b>ENTER</b>                      | Alternately flashing:<br><b>HOLD &amp; 0.00</b>                           | The cone number has been accepted and the hold time is entered now.  |
| <b>05</b>                         | <b>.05</b>  | The Hold time is displayed. Numbers to left of decimal point are hours, to the right of decimal point are minutes. If you type a wrong number, press zero 4 times, then type the correct number.   |
| <b>ENTER</b>                      | <b>IdLE</b> flashes, then the current temperature, etc                    | Accepts a hold time of 5 minutes and then <b>IdLE</b> indicates the heating part of the program is complete  |
| <b>Other, Other, Other, Other</b> | <b>16-S</b>   | This means "16 segment". This is how we add the two programs to each other.  |
| <b>ENTER</b>                      | <b>OFF</b>  | The 16 segment feature is turned off as the default setting.   |
| <b>1</b>                          | <b>On</b>   | Pressing 1 turns the 16 segment feature on. You can toggle between <b>OFF</b> and <b>On</b> by pressing <b>1</b> again.  |
| <b>ENTER</b>                      | <b>IdLE</b>   | You have now activated the 16 segment hfeature which will start VARY-FIRE Program No 6 when the EASY-FIRE program finishes   |
| <b>START/STOP</b>                 | <b>-On-</b>   | Starts the program..   |
| <b>Review Prog</b>                |   | You will see 16-S at the end of the displays that scroll. This tells you that VARY-FIRE Program #6 will start when your EASY-FIRE program ends.  |

## 4.2 VARY-FIRE

The VARY-FIRE mode allows you to program exactly how you want the kiln to fire. It provides a very broad range of programming possibilities designed to allow for the many different ways these kilns can be used. The Dynatrol allows you to permanently store 6 separate programs with up to 8 ramp/hold segments in each program. There is one cooling or heating ramp, a temperature setpoint, and an optional hold time at that setpoint, per segment. These programs are stored in a non-volatile memory bank, which means that they will stay in memory even when all power is turned off. The Dynatrol allows you to hold at a low temperature for a long time (i.e. you can have an automatic drying period similar to the Preheat option in the EASY-FIRE mode). Then it can automatically ramp up to your final temperature, switching to different heating or cooling rates along the way. You can ramp slowly through critical periods or soak at any temperature within, or at the end of a firing, for more consistent maturing of work. Your program can include a controlled cool down to avoid heat shock. Many of these options are permanently programmed into the EASY-FIRE programs to maximize their ability to properly fire your ceramics. However, with the VARY-FIRE programs you have complete control over nearly every aspect of the firing so you can adjust the kiln performance to your exact needs. **This can allow the kiln to be used for non-ceramic applications such as glass slumping, annealing, enameling, growing crystals, jewelry, heat treating, testing, and other industrial uses.**

In the VARY-FIRE mode your saved programs are called **USER1, USER2, ... USER6**. These are the names that will define your programs and make them easy to recall in order to use them to fire the kiln.

These six programs slots; **USER1, USER2, ... USER6** etc come with generic programs already in place. These programs can be replaced with your own custom programs, and at any time in the future the original programs can be recalled. If they are recalled however, they will replace any of your custom programs that you have saved under **USER1, USER2, ... USER6**.

The six pre-set programs in the VARY-FIRE's custom program slots are as follows:

**USER1** is a glass slumping program

**USER2** is a glass tack fuse program

**USER3** is a glass full fuse program

**USER4** is a glass bead annealing program

**USER5** is a lost-wax burnout program

**USER6** is a slow cooling cycle that can be added to a CONE 6 firing (or can be altered to add to any firing) but only when the 16-S option is selected



NOTE: See the Appendix I section in this manual for exactly what each of these programs will do.

VARY-FIRE programs in general are best thought of in the terms of a chart. For example: a three segment program with a maximum set point temperature of 1575°F, a one hour hold time, and a controlled cooldown. In segment 1, ramp rates are at first only 100°F per hour until the entire kiln's temperature reaches 200°F. Then, with no hold time in segment 1, the control automatically switches to segment 2, which will allow the kiln to rise at 500°F per hour until its maximum setpoint at 1575°F. Then it will hold for one hour at 1575°F. Then, in segment 3, it will cool from 1575°F to 1000°F at 143°F per our. Once the kiln temperature cools to 1000°F the firing is complete and the kiln heaters will turn off.

# DYNATROL REFERENCE MANUAL (Blue 700- Rev 5.0)

| Segment | Rate °F/hour | Temperature | Hold           |
|---------|--------------|-------------|----------------|
| 1       | 100°F/Hour   | 200°F       | 0              |
| 2       | 500°F/hour   | 1575°F      | 1 hour (01.00) |
| 3       | 143°F/hour   | 1000°F      | 0              |

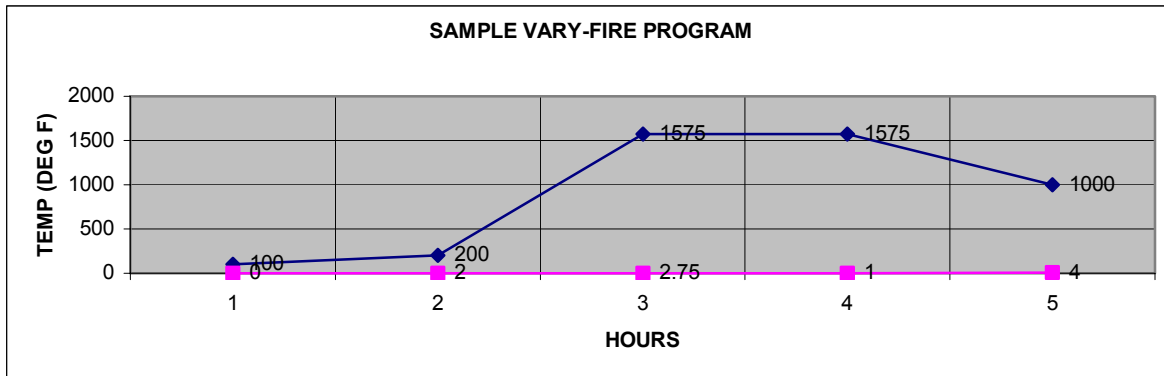

**NOTE:** The Appendix section has a blank form for writing your firing programs. Photo-copy this form as needed.

## 4.2.1 VARY-FIRE Example

The following steps are used to enter a program under **USER 1** for the firing profile in the above example.



**NOTE:** You can change the program's name (the USER number), change the number of segments, and change the ramping rates, segment setpoints and hold times within each of the segments. You can even add a DELAY time to ensure that you will be around for the end of the firing, all to fit the program to your own specific needs.

| Press             | Display   | Comment  |
|-------------------|---|--|
| <b>Enter Prog</b> | Alternately flashing:<br><b>USER &amp; #</b>    | The display alternates between <b>USER</b> and the last selected firing profile number.  |
| <b>1</b>          | <b>1</b>  | Selects user ( <b>USER</b> ) profile number <b>1</b> . Only choose USER 1 if you wish to program over the program that is already there. |
| <b>ENTER</b>      | Alternately flashing:<br><b>SEGS &amp; No.</b>  | The displays flashes between <b>SEGS</b> and the number of segments which were previously selected for this profile.                     |
| <b>3</b>          | <b>3</b>  | This is the number of segments needed for our example profile.   |
| <b>ENTER</b>      | Alternately flashing:<br><b>RA 1 &amp; No.</b>  | The display flashes between <b>RA 1</b> and the heating rate per hour of the previously selected for this profile.                       |
| <b>100</b>        | <b>100</b>                                      | Displays the selected rate/hour.   |
| <b>ENTER</b>      | Alternately flashing:<br><b>°F 1 &amp; No.</b>  | The display flashes between <b>°F 1</b> & the temperature which was previously selected for this profile.                                |
| <b>200</b>        | <b>200</b>                                      | Displays the selected temperature  |
| <b>ENTER</b>      | Alternately flashing:<br><b>HLd 1 &amp; No.</b> | The display flashes between <b>HLd 1</b> & the hours and minutes which were previously selected for this profile.                        |

## DYNATROL REFERENCE MANUAL (Blue 700- Rev 5.0)

|       |   |   |
|-------|---|---|
| 0     | . 0   | No hold time.   |
| ENTER | Alternately flashing:<br>RA 2 & No.                     | The display flashes between RA2 & the heating rate previously selected for this profile.  |
| 500   | 500   | Displays the selected rate/hour.  |
| ENTER | Alternately flashing:<br>°F 2 & No.                     | The display flashes between °F2 & the temperature which was previously selected for this profile  |
| 1575  | 1575  | Displays the selected temperature.  |
| ENTER | Alternately flashing:<br>HLd2 & No.                     | The displays flashes between HLd2 & the previously selected hold time.  |
| 0100  | 1.00  | One Hour hold time at 1575°F. (Normally with pottery you would rarely hold at the top temp/cone. Holding here adds heat work... an hour hold can make it 2-3 cones hotter. Type "0" for no Hold)) |
| ENTER | Alternately flashing:<br>RA 3 & No.                     | The display flashes between rA3 & the heating rate previously selected for this profile.  |
| 143   | 143   | Displays the selected rate/hour.  |
| ENTER | Alternately flashing:<br>°F 3 & No.                     | The display flashes between °F3 & the temperature which was previously selected for this profile  |
| 1000  | 1000  | Displays the selected temperature.  |
| ENTER | Alternately flashing:<br>HLd3 & No.                     | The displays flashes between HLd2 & the previously selected hold time.  |
| 0     | . 0   | No hold time.   |
| ENTER | Alternately flashing:<br>ALRM & No.                     | The display alternates between ALRM & the previously used alarm setting.  |
| 9999  | 9999  | Enters the temperature at which the alarm will sound. The alarm will be turned off with a setting of 9999.  |
| ENTER | CPL flashes then<br>IdLE and the<br>current temperature | CPL flashes indicating the program has been completed. IdLE then the current temperature flashes in the display.  |



### **NOTE: Preheating (Candling) with VARY-FIRE**

There is no actual **Preheat** option in the VARY-FIRE mode. You must include another segment in your program in order to "Preheat". To preheat in the VARY-FIRE mode you would make your first segment as follows:

**rA1 60**

**°F1 200 -**

**HLD1** (time you wish to preheat for)

### **4.2.2 Downramping, or Controlled Cooling with VARY-FIRE**

To have the kiln cool at a prescribed rate, slower than it's natural rate, within a program or at the end of a firing, first consider the following. A kiln with a light load or a large firing chamber will cool more quickly than a kiln with a heavy, dense load or a small firing chamber assuming the

## DYNATROL REFERANCE MANUAL (Blue 700- Rev 5.0)

same thickness of the insulation. So you may want to test your kiln to see how quickly it cools at high temperatures and at low temperatures to see what type of cooling segment(s) you need.

When using just VARY-FIRE programming, treat a cooling segment the same as a heating segment when programming the Dynatrol. While programming, you must initially add an extra segment. Then, when you input the **RA** number in this segment (ramp or rate of rise or fall in °F or °C per hour), this number will be the number of degrees per hour that you want the kiln to COOL. Next in that segment, when you input the **°F** (or **°C**) number (the segment's set point), this number will be the temperature *to which* the kiln will cool to, at the rate you have just programmed. You can then program a hold (if you need one here) at this temperature. The program can then end (this was your last segment) or it can continue on cooling or go back to heating in the next segment.

All that the Dynatrol knows, is that to be a cooling segment, the set point must be *LOWER* than the previous segment's set point. It will treat the ramp rate the same for either heating or cooling, just moving the temperature along at the prescribed rate. (See the previous example for the VARY-FIRE).



**NOTE:** When programming a firing with a controlled cooling, be sure to put at least one heating segment before the cooling segment as the kiln cannot cool first. It must heat first before cooling.

### 4.2.3 Using VARY-FIRE to fire to a CONE number

You can write a VARY-FIRE Program, and rather than have to set a *temperature* as the hottest point, you can set a *Cone Number* as the hottest point. This is very useful when you want your glazes fired to say "cone 6". The VARY-FIRE program will actually adjust the final temperature in the segment where you programmed a cone number as the set point. All subsequent set points in later segments must be lower in temp than the Cone segment.

In order to do this; while you are programming the VARY-FIRE program and you come to the point where you would normally enter the hottest *temperature*, press **Other** instead of entering a top temperature. Now enter in the appropriate cone number, then press **ENTER** and continue on with that segment's hold time and any later cooling segments etc...

If you change your mind, pressing **Other** before you enter a cone number will take you back to where you can input a temperature rather than a cone number for that segment.

**Example: (Same program as the earlier example, just going to a cone number instead of 1575)**

| Press             | Display  | Comment   |
|-------------------|--|---|
| <b>Enter Prog</b> | Alternately flashing:<br><b>USER &amp; #</b>   | The display alternates between <b>USER</b> and the last selected firing profile number.   |
| <b>1</b>          | <b>1</b>                                       | Selects user ( <b>USER</b> ) profile number <b>1</b> . Only choose <b>USER 1</b> if you wish to program over the program that is already there. |
| <b>ENTER</b>      | Alternately flashing:<br><b>SEGS &amp; No.</b> | The displays flashes between <b>SEGS</b> and the number of segments which were previously selected for this profile.                            |
| <b>3</b>          | <b>3</b>                                       | This is the number of segments needed for our example profile.  |
| <b>ENTER</b>      | Alternately flashing:<br><b>RA 1 &amp; No.</b> | The display flashes between <b>RA 1</b> and the heating rate per hour of the previously selected for this profile.                              |
| <b>100</b>        | <b>100</b>                                     | Displays the selected rate/hour.  |
| <b>ENTER</b>      | Alternately flashing:<br><b>°F 1 &amp; No.</b> | The display flashes between <b>°F 1</b> & the temperature which was previously selected for this profile.                                       |

## DYNATROL REFERANCE MANUAL (Blue 700- Rev 5.0)

|              |   |   |
|--------------|---|---|
| <b>200</b>   | <b>200</b>  | Displays the selected temperature   |
| <b>ENTER</b> | Alternately flashing:<br><b>HLd1 &amp; No.</b>                  | The display flashes between <b>HLd1</b> & the hours and minutes which were previously selected for this profile.  |
| <b>0</b>     | <b>. 0</b>  | No hold time.   |
| <b>ENTER</b> | Alternately flashing:<br><b>RA 2 &amp; No.</b>                  | The display flashes between <b>RA2</b> & the heating rate previously selected for this profile.   |
| <b>500</b>   | <b>500</b>  | Displays the selected rate/hour.  |
| <b>ENTER</b> | Alternately flashing:<br><b>°F 2 &amp; No.</b>                  | The display flashes between <b>°F2</b> & the temperature which was previously selected for this profile   |
| <b>Other</b> | <b>CONE &amp; No.</b>   | This is where we are entering a cone number for the max temp rather than a temperature  |
| <b>012</b>   | <b>012</b>  | Cone 012 is roughly equal to heating to 1575F at 108degrees F per hour. We are choosing to enter a cone number here because we really want to hit cone 012... not whatever 012 would look like at 1575. |
| <b>ENTER</b> | Alternately flashing:<br><b>HLd2 &amp; No.</b>                  | The displays flashes between <b>HLd2</b> & the previously selected hold time. Done with the cone part- back to the regular VARY-FIRE program  |
| <b>0100</b>  | <b>1.00</b>   | One Hour hold time at 1575°F (Normally with pottery you would rarely hold at the top temp/cone. Holding here adds heat work... an hour hold can make it 2-3 cones hotter. Type "0" for no hold)         |
| <b>ENTER</b> | Alternately flashing:<br><b>RA 3 &amp; No.</b>                  | The display flashes between <b>RA3</b> & the heating rate previously selected for this profile.   |
| <b>143</b>   | <b>143</b>  | Displays the selected rate/hour.  |
| <b>ENTER</b> | Alternately flashing:<br><b>°F 3 &amp; No.</b>                  | The display flashes between <b>°F3</b> & the temperature which was previously selected for this profile   |
| <b>1000</b>  | <b>1000</b>   | Displays the selected temperature.  |
| <b>ENTER</b> | Alternately flashing:<br><b>HLd3 &amp; No.</b>                  | The displays flashes between <b>HLd2</b> & the previously selected hold time.   |
| <b>0</b>     | <b>. 0</b>  | No hold time.   |
| <b>ENTER</b> | Alternately flashing:<br><b>ALRM &amp; No.</b>                  | The display alternates between <b>ALRM</b> & the previously used alarm setting.   |
| <b>9999</b>  | <b>9999</b>   | Enters the temperature at which the alarm will sound. The alarm will be turned off with a setting of <b>9999</b> .  |
| <b>ENTER</b> | <b>CPL</b> flashes then <b>IdLE</b> and the current temperature | <b>CPL</b> flashes indicating the program has been completed. <b>IdLE</b> then the current temperature flashes in the display.  |



### 4.2.4 Adding Two VARY-FIRE Programs Together

The USER 6 program can be added to any EASY-FIRE or to VARY-FIRE program USER 5. USER 6 comes pre-programmed as a slow cooldown from a Cone 6 firing. It can be adapted to be a slow cooldown from a different cone number or temperature, or with a few adjustments it can be it's own program, or it can be the second half of a sophisticated crystalline glaze program.

To add whatever is programmed in USER 6 to whatever you program in USER 5 you must check and be sure USER 5 is programmed the way you want it. Then be sure USER 6 is programmed the way you want it. Think of the first segment of USER 6 following right after the end of USER 5.

# DYNATROL REFERANCE MANUAL (Blue 700- Rev 5.0)

Then turn on the **16-S** feature- located under the **Other** key so the control knows to join those two programs together and run first USER 5, then immediately follow it with USER 6



## 4.2.5 The UNDO/GO-BACK Button

The **Review Prog** (Review Program) button acts as the Go-Back button during VARY-FIRE Programming only. If you are programming a segment of a VARY-FIRE program, you can go backwards to change something if you need to by pressing **Review Prog**. Once you reach the ALRM, 9999 part of the programming you can no longer go backwards. Likewise, while you are programming your USER # or number of segments you cannot go backwards either.

If you cannot go back, just continue on and finish programming like nothing was wrong. Then when you get back to **IdLE**, go back in and program it correctly.

You cannot go backwards in the EASY-FIRE programming at all. Just finish programming as if no mistake was made, then once you are back to **IdLE**, re-program it correctly.

## 4.2.6 The RECALL PROG (RECALL PROGRAM) Button

This button is used to call up one of your six previously programmed USER firing profiles in order to use that program to fire the kiln.

**Example:** To recall USER profile #4, do the following. First enter your program into User Profile #4, then:

| Press              | Display  | Comment  |
|--------------------|--|--|
| <b>Recall Prog</b> | Alternately flashing:<br><b>USER &amp; 1</b>     | The controller is ready to accept the desired user number.   |
| <b>4</b>           | <b>4</b>   | Indicates the user program selected.   |
| <b>ENTER</b>       | <b>IdLE</b> flashes then the current temperature | <b>IdLE</b> appears indicating the program has been selected. The current temperature then flashes in the display. |

## 4.2.7 The SKIP-STEP Feature

The Skip Step function is performed using the **Review Seg** (Review Segment) button. The Skip Step feature is only available in a VARY-FIRE firing profile. It is used when enough heat work has been done at the current segment and you want to immediately go the next segment. To skip to the next segment, press **Review Seg**, then within 2 seconds, press **ENTER**, and **ENTER** a second time. If you press **View Seg** and do not press **ENTER** within 2 seconds, the current segment (e. g., **rA1**) will continue to be displayed. Simply wait until the temperature is again displayed and press **Review Seg**, then **ENTER** within 2 seconds, and **ENTER** again. If you press **Review Seg**, then **ENTER**, then decide not to skip to the next ramp stage, simply do not press any key; after about 10 seconds the display will return to the current temperature.

If you are currently in the ramping part of the segment and you skip step you will jump over any hold time in that segment and go directly to the ramp in the next segment. If you are currently in the hold part of a segment and you skip a step you will just go to the ramp in the next segment.

## 4.2.8 Full Power Ramp

A full power ramp will be enabled if a ramp rate of 9999 degrees per hour is programmed. At the start of a full power up ramp the elements will continuously be on until the soak temperature is



## DYNATROL REFERANCE MANUAL (Blue 700- Rev 5.0)

reached. At temperatures 50 degrees less than the programmed soak temperature the elements will begin to cycle to minimize overshoot. A full power ramp is the quickest way to reach a specified temperature.

### 4.3 VIEW/ REVIEW AND SPECIAL OPTIONS

#### 4.3.1 Review Prog (Review Program)

This feature is useful to be sure that the program that you have just selected to fire the kiln, either one of the preprogrammed EASY-FIRE programs or one of your six USER programs, is the one that you think it is.

**Example** - If you have selected a Slow Bisque “EASY-FIRE” profile to cone 04 with a 20 minute hold, the following will be displayed, each for about 1/2 second when **Review Prog** is pressed:

| Display | Comment   |
|---------|---|
| S-bC    | Slow Bisque firing profile  |
| PRHT    | Indicates the next value will be the preheat hold time                            |
| 0.00    | No preheat hold time is selected  |
| CONE    | Next value will be the selected cone number                                       |
| 04      | Selected cone number  |
| °F      | next number will be the cone temperature  |
| 1926    | Dynatrol’s temperature for cone 04  |
| CNOS    | Indicates the next value will be the amount of offset applied to that cone number |
| 0       | There is no offset- Offset is degrees +/- you can add to a cone’s temp equivalent |
| HOLD    | Next number will be the hold or soak time at the end of the firing                |
| 0.20    | 20 minutes hold selected  |
| dELA    | next number will be the delay time before the start of firing                     |
| 0.00    | No delay, firing will start when <b>START/STOP</b> is pressed                     |
| ALRM    | Next number will be the high alarm limit setting                                  |
| 9999    | This is as high as the alarm can be set and assures the alarm will be off         |
| ERCd    | Next message will indicate if the error codes are ON or OFF                       |
| ON      | Error codes are <b>ON</b>   |
| FIRE    | Next number is the number of times the kiln has been fired                        |
| 25      | Kiln has been fired 25 times (yours may say a different number here)              |
| IdLE    | End of firing profile- it goes back to IdLE                                       |

## DYNATROL REFERANCE MANUAL (Blue 700- Rev 5.0)

### 4.3.2 Review Seg (Review Segment)

This feature is used while firing to see where the kiln is in the program, what the travelling set point is currently set for, and what the ambient temperature of the Dynatrol's electronics is.

Examples:

| If you press Review Seg, and the FIRST message that is displayed is...  | It Means   |
|---|--|
| <b>STOP</b>   | No firing is in progress, the controller is currently idling ( <b>IdLE</b> , <b>tC2</b> , temp.)   |
| <b>rA 4</b>   | Kiln firing, ramp stage in segment 4, 500 degrees per hour rate of rise  |
| <b>rA 3</b>   | Kiln firing, ramp stage in segment 3, 50 degrees per hour rate of rise   |
| <b>HLd2</b>   | Kiln firing, hold stage in segment 2   |
| <b>HLd6</b>   | Kiln firing, hold stage in segment 6   |
| <b>If you press Review Seg, the SECOND message that is displayed is...</b>  | <b>It Means:</b>   |
| The Travelling Set Point: in the form of a temperature number in whatever temperature scale you are using. i.e. <b>SETP 200</b> | This number is constantly changing based on how you have programmed the kiln. The Dynatrol looks at the entire program you have entered and then plots the course of the Travelling Set Point. Once the firing has started and the elements are heating, the thermocouples are registering the temperature in the kiln. These temperatures are constantly compared to the Travelling Set Point and their relationship is what determines whether or not the elements stay on or are turned off in each zone of the kiln. |
| <b>If you press Review Seg, the THIRD message that is displayed is...</b>   | <b>It Means:</b>   |
| The ambient temperature of the Dynatrol's electronics in the control panel.<br>i.e. <b>bd T 100</b>                             | This temperature can tell you if you are operating the kiln in a detrimental and possibly unsafe environment. The recommended maximum ambient temperature is 125°F. If your temperature reads hotter than that you could damage the Dynatrol over time. Something else to consider is the fire hazard issue (see the general kiln instructions for precautions on this)  |

### 4.3.3 The 'Other' Button

The **Other** button contains a menu which contains many of the different user-programmable settings. As you press **Other** again and again the menu will scroll by. You can press **Review Seg** to go backwards in the menu. NOTE: You can not access the **Other** menus while the control is firing a program.

#### The Other Menus:

- Reset feature **RSET**
- Cone Lookup Table **CONE**
- Controller ID **Id**
- 16 step program **16-S** (only comes up if you have VARY-FIRE Program #5 in active memory or if you have an EASY-FIRE program in active mememory)
- Cone temperature offsets **CNOS**
- Temperature scales °F or °C **CHG°**
- Error codes ON or OFF **ERCd**
- Thermocouple offset **TCOS**
- Board temperature **bd T**



**TO EXIT this menu without changing anything, cycle through by pressing Other until CONE appears, then press ENTER twice.**

#### 4.3.3.1 Reset

**RSET** - Choosing this function will re-assign the default value (**ON**) to the Error codes only. Press **Other** until **RSEt** is displayed. Then press **ENTER**. **IdLE** will be displayed indicating that the Error Checking to **ON**. It is also the screen where you can enter the “hidden other menu”.

#### 4.3.3.2 Cone Lookup Table

**CONE** - This option allows you to type in a cone number and see what the Dynatrol's programmed temperature is for that cone number at a temperature climb of 108°F per hour. This function is provided as a handy reference table to use while you are programming. There is a more complete cone table in “Logs, Cones, Tips” section of the Owners Manual. Remember, however, that there is no absolute equivalent between cones and temperature.

#### Cone Table Example:

| Press                  | Display  | Comment  |
|------------------------|--|--|
| <b>Other<br/>Other</b> | <b>CONE</b>  | The word <b>CONE</b> will appear on the display  |
| <b>ENTER</b>           | Alternately flashing: <b>CONE</b><br>& a cone number. This<br>example: <b>CONE, 07</b> | The word <b>CONE</b> and a cone number will alternately flash on the display.  |
| <b>04</b>              | <b>04</b>  | This is the cone we are looking up in this example   |
| <b>ENTER</b>           | <b>1945</b>  | The cone temperature is displayed for 2 seconds then <b>IdLE</b> is displayed followed by the flashing current temperature |

# DYNATROL REFERANCE MANUAL (Blue 700- Rev 5.0)

## 4.3.3.3 Identification

**Id** - Used by KISS (Kiln Interface Software System) to identify the kiln when hooked to a personal computer. This software is available from L&L. Normally this is set to 1. If you are not using the control in a KISS environment it doesn't matter what it says.

## 4.3.3.4 Sixteen Segment Program

**16-S** - This option allows VARY-FIRE profile #5 or any EASY-FIRE program to be combined with USER 6 to make one profile with up to 16 segments. It shows up in the **Other** menu only when VARY-FIRE #5 Profile or any EASY-FIRE program has been programmed . To use it, first, program VARY-FIRE Profile #5 or an EASY-FIRE program. Then program VARY-FIRE Profile #6. Note that the beginning segment of Profile #6 should be entered as if it was to start directly after the ending segment of the EASY-FIRE program or of VARY-FIRE profile #5.

To take advantage of this feature do the following:

| Press                 | Display        | Comment   |
|-----------------------|----------------|---|
|                       |                | First, program VARY-FIRE Profile #6<br>Then VARY-FIRE Profile #5. Then...   |
| <b>RECALL PROGRAM</b> | <b>USER, 1</b> | This is asking which program to recall, you can press 5.  |
| <b>5</b>              | <b>5</b>       | USER profile number 5 containing at least the first half of your program has been chosen, press <b>ENTER</b> .      |
| <b>ENTER</b>          | <b>IdLE</b>    | The program USER 5 has been recalled  |
| <b>Other (4x)</b>     | <b>16-S</b>    | Press <b>Other</b> until the <b>16-S</b> appears. Press <b>ENTER</b> to accept the option.                          |
| <b>ENTER</b>          | <b>OFF</b>     | This option is currently off. Use any number key to toggle between ON and OFF                                       |
| <b>1</b>              | <b>ON</b>      | This turns on the 16 segment programming – linking program #5 and program #6, press <b>ENTER</b> .                  |
| <b>ENTER</b>          | <b>IdLE</b>    | This activates and confirms the programming   |
| <b>START</b>          |                | The controller will fire VARY-FIRE Profile #5 until complete and then will fire VARY-FIRE Profile #6 until complete |



**NOTE:** If you just want **USER5** to fire without automatically being followed by whatever is programmed in **USER6** double-check that this option is set to **OFF** . It will show up in the Program Review. If you have activated the **16-S** feature and you press **Review Prog** it will only show you the first half of the program; USER 5 or the EASY-FIRE program. It will not show you the contents of USER 6 in the Review Program. It will show you “**16-S**” as it scrolls through the Review Program. This is your clue that whatever is in USER 6 is going to follow your current program.

## 4.3.3.5 Cone Offset

**CNOS (Cone Offset)** - Used to fine tune what the Dynatrol thinks the final cone temperature should be in EASY-FIRE programs. The final cone temperature can be raised or lowered a maximum of 99°F (or 55°C). When entering the offset temperature the following code is used: the left two digits designate whether to raise (**00**) or lower (**90**) the cone temperature, that is, “**00**” means plus (+) and “**90**” means minus (-). The right two digits are the number of degrees the cone temperature will be raised or lowered. This offset will remain programmed only for the specific cone number until you reprogram the cone offset differently

## DYNATROL REFERANCE MANUAL (Blue 700- Rev 5.0)

### Examples:

| Number | Meaning                                  |
|--------|--|
| 0020   | Raise the final cone temperature by 20°F |
| 0040   | Raise the final cone temperature by 40°F |
| 0015   | Raise the final cone temperature by 15°F |
| 9030   | Lower the final cone temperature by 30°F |
| 9005   | Lower the final cone temperature by 5°F  |
| 9045   | Lower the final cone temperature by 45°F |



**NOTE:** This option does not affect the **VARY-FIRE (Ramp-Hold)** mode but it will show up on the menu.

**NOTE ABOUT PREPROGRAMMED CONE OFFSETS:** The Cone Offsets come preprogrammed. From cone 022 to cone 017 the cone offsets are set at 9020. All other cones are preset at 0000. (Note on Blue DynaTrols made before Oct 1 2004 the cone offset was 9030 for cones 022 to 017 and 9020 for other cones. The offsets were changed when we switched to a more responsive thermocouple protection tube). You can always change this. The **RESET** option in **Other** menu will *NOT* reset these settings. This is part of the compensation necessary for the mullite thermocouple protection tubes.

**Cone Offset Example:** Adjust cone 07 to shut off the kiln at 20°F below Orton's prescribed cone temperature.

| Press                        | Display  | Comment  |
|------------------------------|--|--|
| <b>Other</b><br><b>Other</b> | <b>CN0S</b>                                      | If <b>CN0S</b> does not show on the display, press the <b>Other</b> key until <b>CN0S</b> displays.  |
| <b>ENTER</b>                 | Alternately flashing:<br><b>CONE &amp; #</b>     | Cone Offset has been selected; the word <b>CONE</b> and the last entered cone number will alternately flash on the display. Now enter the cone number which you want to adjust (in this example cone 07) |
| <b>07</b>                    | Alternately flashing:<br><b>CONE &amp; 07</b>    | The word <b>CONE</b> and the entered cone number ( <b>07</b> ) will alternately flash on the display. If you type a wrong number, press zero 3 times, press <b>ENTER</b> , then type the correct number. |
| <b>ENTER</b>                 | Alternately flashing:<br><b>°FOS &amp; 0</b>     | <b>°FOS</b> and the previous offset setting alternately flash. Enter the new offset temperature using the rules above, in this example, <b>9020</b>  |
| <b>9020</b>                  | <b>9020</b>                                      | The selected offset temperature is displayed. If you type a wrong number, press zero 4 times, then type the correct number.  |
| <b>ENTER</b>                 | <b>IdLE</b> flashes then the current temperature | <b>IdLE</b> appears indicating the offset temperature adjustment has been accepted. The current temperature then flashes in the display.   |

## DYNATROL REFERANCE MANUAL (Blue 700- Rev 5.0)

### 4.3.3.6 Change from Deg F to Deg C

**CHG°** - Used to select degrees Fahrenheit (°F) or degrees Celsius (°C).

**Example:** Change from °F to °C.

| Press              | Display  | Comment  |
|--------------------|--|--|
| <b>Other Other</b> | <b>CHG°</b>                                      | If <b>CHG°</b> does not show on the display, press the <b>Other</b> key until <b>CHG°</b> displays.  |
| <b>ENTER</b>       | <b>°F</b>  | Indicates that the Fahrenheit (°F) scale is being used. You can toggle back and forth between °F and °C by pressing the <b>1</b> key.  |
| <b>1</b>           | <b>°C .</b>                                      | Displays <b>°C .</b> <b>The decimal point in the lower right corner means that the Celsius (centigrade) scale has been selected.</b>   |
| <b>ENTER</b>       | <b>IdLE</b> flashes then the current temperature | <b>IdLE</b> appears indicating the temperature scale has been changed. The current temperature in °C then flashes in the display. There will be a decimal point in the lower right-hand corner of the display. |

### 4.3.3.7 Error Codes (On/Off)

**ERCd** - Used to turn ON or turn OFF the error codes. When you receive your Dynatrol the error codes are turned on. In most cases, you will want the error codes on. They can be turned off if you are doing special firings, such as jewelry or glass firing where the kiln is opened while hot. Turning the error codes off turns off the dynamic zone control feature that keeps the temperature in the kiln even top to bottom. It eliminates nuisance shut downs but side also eliminates built in fail-safe measures that help prevent mistakes.

**Example:** Turn the error codes off.

| Press              | Display   | Comment  |
|--------------------|---|--|
| <b>Other Other</b> | <b>ERCd</b>   | If <b>ERCd</b> does not show on the display, press the <b>Other</b> key until <b>ERCd</b> displays.  |
| <b>ENTER</b>       | <b>ON</b>   | Indicates that the error codes are turned on. You can toggle back and forth between on and off by pressing the <b>1</b> key.                   |
| <b>1</b>           | <b>OFF</b>  | Displays <b>OFF</b> indicating the error codes will be turned off.   |
| <b>ENTER</b>       | <b>IdLE</b> flashes indicating that the error codes have been turned off. | <b>IdLE</b> appears indicating that programming is complete. <b>IdLE</b> , <b>tC2</b> , and the current temperature then cycle in the display. |

### 4.3.3.8 Thermocouple Offsets

**TCOS** - This is used to raise or lower the temperature indicated by any of the thermocouples. The maximum offset is 99°F (or 54°C). A positive offset is entered with **00** preceding the amount of offset and a negative offset is preceded with **90**. This is similar to what is done for entering cone offsets. When **TCOS** is displayed, press **ENTER** and **TC1** will be displayed. Press **ENTER** and the current offset for the top thermocouple will be displayed. Press **ENTER** when the correct offset for the top thermocouples is displayed and then **TC2** will be displayed. Repeat the process for **TC2** and **TC3** only inputting the offset on the thermocouples that need it. **Raising the indicated temperature LOWERS the actual temperature in the kiln and therefore the amount of heat work. Lowering the indicated temperature RAISES the actual temperature in the kiln and therefore the amount of heat work.**

# DYNATROL REFERANCE MANUAL (Blue 700- Rev 5.0)

## Thermocouple Offset Example

Entering this sequence of steps will make the TOP zone of the kiln fire cooler by 15°F than the rest of the kiln. To do this, the offset is performed on the top (#1) thermocouple only, however the rest of the thermocouples must be programmed as well. The other one or two thermocouples (depending on model of kiln) would be programmed for a zero offset.



Reminder: **IdLE**, **tC2**, and the current temperature must be cycling before you begin programming

| Press                  | Display              | Comment  |
|------------------------|----------------------|--|
| <b>Other<br/>Other</b> | <b>tC0S</b>          | Represents thermocouple offset, press <b>ENTER</b>   |
| <b>ENTER</b>           | <b>tC1</b>           | Represents thermocouple #1. The top of the kiln contains <b>tC1</b> so this is the thermocouple that we want to offset. Press <b>ENTER</b> .   |
| <b>ENTER</b>           | <b>°F0S<br/>18</b>   | The Dynatrol is asking how many degrees you wish to add to or take from that thermocouple's displayed reading. NOTE: If this number reads something other than <b>0000</b> , you already have an offset programmed here. Note that the control comes with 18 degrees already preprogrammed in as a thermocouple offset to help compensate for the ceramic protection tube. Press <b>ENTER</b> if you wish to keep this offset, OR press <b>0000</b> and then press <b>ENTER</b> to have no offset on that thermocouple OR in this example we would press <b>33</b> |
| <b>33</b>              | <b>33</b>            | You have now programmed the top thermocouple to read 65°F hotter, therefore making the top of the kiln 65°F cooler, provided of course, that you program no offsets for thermocouples 2 or 3. Press <b>ENTER</b>   |
| <b>ENTER</b>           | <b>tC2</b>           | Press <b>ENTER</b> , you must now enter offsets for thermocouples 2 and 3. In this example we are keeping these offsets set for zero.  |
| <b>ENTER</b>           | <b>°F0S<br/>0050</b> | Keep at <b>0050</b> . If this number reads something other than <b>0050</b> , you already have an changed the default offset programmed here. Press <b>ENTER</b> if you wish to keep this offset.  |
| <b>ENTER</b>           | <b>tC3</b>           | Press <b>ENTER</b>   |
| <b>ENTER</b>           | <b>°F0S<br/>0050</b> | Keep at <b>0050</b> . If this number reads something other than <b>0050</b> , you already have an changed the default offset programmed here. Press <b>ENTER</b> if you wish to keep this offset.  |
| <b>ENTER</b>           | <b>CPL or StOP</b>   | Thermocouple offset programming is complete.   |



**NOTE:** The thermocouple offset will affect the final temperature in that zone only for all EASY-FIRE and VARY-FIRE profiles. It will remain programmed until you reprogram it.

**NOTE: The Thermocouple Offset comes already programmed into the control at 0018 (+ 18 Deg F) when it leaves the factory. Note the the room temperature will show 18 Deg F higher than it actually is. The RESET option in Other will NOT reset these settings. IF YOU DO NOT USE THE THERMOCOUPLE PROTECTION TUBES THEN YOU NEED TO CHANGE THERMOCOUPLE OFFSET TO 0000. (Note that on DynaTrols sent out before Oct 1, 2004 the thermocouple offset was set for 0050)**

### 4.3.3.9 Board Temperature

**bd t** - You may press **ENTER** here to see what the ambient temperature of the Dynatrol's electronics are. This temperature can also be seen while the kiln is firing by pressing **Review Seg** three times. (125°F is an acceptable ambient operating temperature)

## **4.4 HIDDEN “Other” MENU & Programming the Powered Bottom**

This menu contains the programmable settings for the rest of the features in the Dynatrol. To find this menu, first **IdLE**, **tC2**, and the current temperature must be cycling in the display.

|  |
|--|
| Press <b>Other</b> once to see <b>RSET</b> displayed   |
| Press <b>4, 4, 3</b> , and see <b>NOTC</b> (this is the first option in the hidden “Other” menu)   |
| To exit the menu press <b>ENTER</b> twice when you see <b>Pct</b> . You will then see <b>CPL</b> , and then <b>IdLE</b> , <b>tC2</b> , and the current temperature cycling in the display again. |



**WARNING:** ‘OPTION A’(ØPA), ‘OPTION B’(ØPB) DO NOT PRESS **ENTER** HERE. These options are currently programmed to operate with different equipment than our powered bottoms and are therefore not recommended as options for controlling them. If you accidentally press **ENTER** on ØPA or ØPB you must then re-enter the hidden **Other, 4, 4, 3** menu and press **Other, Other, Other** ( a total of three times to scroll to ØPC). If you have a powered bottom then press **ENTER** while you see ØPC. If you do NOT HAVE a powered bottom you must press **ENTER** on **PCT**, set it for all zeros, and press **ENTER** again.

When you press **Other, 4, 4, 3** The “Hidden Other Menu” is displayed as follows:

### **4.4.1 NOTC: Number of Thermocouples**

**NOTC** is used to change the number of zones in your kiln (essentially, the number of thermocouples used).

To run the kiln using only one thermocouple: When you see **notC** press **ENTER**, then **1**, then **ENTER**. If you choose to do this you must use only thermocouple number 2 in the kiln and we recommend putting it in the middle zone’s thermocouple hole. All the zones of the kiln will turn on and off simultaneously when you program the Dynatrol to use only one thermocouple.

If you wish to run the kiln using only two thermocouples: When you see **notC** press **ENTER**, then **2**, then **ENTER**. If you choose to do this you must have thermocouple #1 in the top zone of the kiln and thermocouple #2 in the middle zone or in the bottom zone. When you program the Dynatrol to run using only two thermocouples the bottom zone and the middle zone go on and off simultaneously.

To run the kiln using three thermocouples: When you see **notC** press **ENTER**, then **3**, then **ENTER**. If you choose to do this thermocouple #1 must be in the top zone, thermocouple #2 in the middle, and #3 in the bottom. All three zones will operate independently, tied to their respective thermocouples.

**NOTE:** Kilns with only one thermocouple can be *programmed* to run with two or three thermocouples but because they physically only have one thermocouple the **FAIL** message will be displayed referring to the non-existent thermocouple. You must then re-program for just one thermocouple. Likewise, two section L&L kilns come with only two thermocouples. If you physically add a section to a two section kiln, you be able to add a third thermocouple. But if you program a two section kiln for three thermocouples you will receive the **FAIL** message referencing the non-existent thermocouple. You must then re-program for two thermocouples.



## 4.4.2 OP A: Option A

DO NOT USE

## 4.4.3 OP B: Option B

DO NOT USE

## 4.4.4 OP C: Option C

When you press **ENTER** here all you will see is **CPL** (meaning 'Complete'). Now when you program in VARY-FIRE mode however, you will see an extra prompt in each segment called **FAN1, FAN2,...FAN8**. This will appear right before you see the **rA1, rA2,...rA8** prompt. **FAN**, in this application, is referring to the powered bottom. You can set the powered bottom to be either **ON** or **OFF** in each segment of programming in a VARY-FIRE program only. Toggle between **ON** and **OFF** using a number key.

## 4.4.5 PCT: Percent

When you press **ENTER** here you can either exit the menu by pressing **ENTER** again (you are essentially setting the percent to remain as is without changing it by doing this). Or else you can program this setting to turn your powered bottom on *a percent of the time that the bottom zone in the kiln is on*. To set this percent from 0% to 150% press the percent you want. i.e. Entering **100** here would turn the powered bottom on whenever the bottom zone came on. Entering **50** here would turn the powered bottom on for about eight seconds, then off for about eight seconds if the bottom zone of the kiln was on all the time. **150** is the maximum you can enter. This pretty much ensures the power bottom is on all the time. The bottom zone would have to be on less than about 66% of the time to have the power bottom cycle if **PCT** was set to **150**.

**NOTE:** Setting the **PCT** setting to **0000** will turn off all powered bottom options.

## 4.4.6 Pld: PID Setting

This setting is not part of the powered bottom settings, It is always "on". Pressing **ENTER** here allows you to set another percent setting that can help a slow, heavily loaded kiln fire faster. This setting comes pre-programmed at the factory for 65%. Basically you are determining how much help the middle zone of the kiln gives the bottom zone of the kiln when the bottom zone is lagging behind during heating. This function automatically activates to your pre-programmed setting when the bottom zone is on 100% of the time. Without this feature, heat from the bottom zone will rise up and help to heat the other zones so generally the bottom of the kiln is on more than the other zones to compensate for this. Sometimes the slow bottom zone will slow the whole kiln down. With this feature, the middle zone of the kiln will come on the programmed percent of the time that the TOP zone comes on, if the bottom zone is on all the time. What was found during tests was that if the bottom was on 100% of the time, the top zone was generally on 90% of the time, but the middle zone was on only about 40% of the time. By programming a higher percent you can greatly speed up your firings. (you will have to experiment, try the factory setting 65% then try maybe 85% and compare your results).

## 4.4.7 dIAG: Diagnostics

This is handy to use when your kiln is first delivered and set up to make sure it was done properly. It can also be useful in seeing if an element has burned out. Press **ENTER** when you see **dIAG** and open the lid of your kiln. When you are ready, press Enter again and each zone of the kiln will turn on for 10 seconds starting with zone #1, the top zone. If you have a powered bottom it will be

## DYNATROL REFERANCE MANUAL (Blue 700- Rev 5.0)

on last; when it says OUT4. **CAREFUL it can get hot and there is LIVE electricity – DO NOT TOUCH THE ELEMENTS!** This will tell you if all the power circuits are hooked up right and working; , or if kiln sections are plugged in to the wrong receptacles on the control panel(jupiter kilns only). If this is the case the zones will not turn on in the proper 1, 2, 3, order.

### 4.4.8 ShTO: Shut-Off Averaging

This option is used to shut off the automatic feature in the Dynatrol that holds the hottest part of the kiln at each segment's set point until the average of the three (or two) thermocouples reaches that set point. Pressing **1** here allows you to toggle between **ON** and **OFF**. **ON** meaning that as soon as the hottest zone gets to the segment's set point the entire kiln switches to either the "hold time" or the next segment. **OFF** meaning that the Dynatrol will not let the hottest zone's temperature rise until the average temperature of the three zones reaches that segment's set point. Then the kiln can begin the "hold time" or the next segment. You may want to turn this setting to **ON** if you fire with the "Lag" set for say 15 and the "Autolag" OFF. **ON** can also help to speed up a slow firing as well.

### 4.4.9 ALR4: Alarm For...

This feature is activated by pressing **ENTER** when **ALR4** is displayed. It energizes output #4 on the DynaTrol electronics board when the Alarm goes off. Since the alarm is a temperature alarm; can be set to go off at a specific temp, output 4 can be connected (for example) to a relay that governs the power for an auto-dialer to call your cell phone so you know it is time to come check the kiln. Or it could be connected to a really loud buzzer or light for the kiln room door. Contact the factory if you want to learn more.

**NOTE: On kilns with powered bottoms DO NOT CHOOSE THIS OPTION.** Your Powered Bottom is connected to output #4 and is best controlled by the 'PCT' option in the Hidden Other Menu. If this option is chosen, *and* you have a powered bottom, *and* you set the alarm, when the alarm goes off the powered bottom will come on- even if the program is off. The bottom of your kiln could get a bit hot if this happens. Just another reason why it is good to never leave a firing un-attended.

### 4.4.10 CYCL: Cycle Time

The cycle time is the length of time between an element turning on two consecutive times. Using a short cycle time may improve temperature control, while using a long cycle time may improve relay life. Cycle time can be programmed anywhere from 10 to 60 seconds. The default setting from the factory is 14 seconds

### 4.4.11 MAX: Maximum Temperature Setting

Maximum Temperature Setting controls how hot the kiln can be programmed to fire. It can be set as high as 2400°F, although on any L&L the max temp in the warranty literature is "2350°F or Cone 10". This is already set in the factory.

### 4.4.12 TYPE: Type of Thermocouple

The type of thermocouple can be either Type K or Type S. You must have the appropriate thermocouples and lead wire to switch from one to the other; either Type K thermocouples and wire or Type S. In addition you must switch the software setting from "K-TH" to "S-TH", or vise versa. Pressing any number key toggles you back and forth from K-TH to S-TH. For precaution, a small jumper must be moved on the circuit board when going from K to S. This jumper is located approximately in the center of the board under the marking "R97". If the jumper is on only one of

## DYNATROL REFERANCE MANUAL (Blue 700- Rev 5.0)

the prongs the control is set for Type K. If the jumper is on both of the two prongs the control is set for Type S. This precaution keeps you from accidentally having it set for K with S thermocouples or vice-versa. (A severe overfiring can occur if you have the control programmed for a Type S thermocouple and you are using a type K thermocouple). If there is a mismatch between the jumper setting and the software setting you will get an error code: **ERR9**.

### 4.4.13 2KEY: Two- Key Start

Two-Key Start is a safety feature that makes you press **ENTER** after pressing **START/STOP** to begin a program. It keeps you from turning the kiln on by accident. If Two-Key Start is activated, when you press **START/STOP** you will see “----“. Pressing **ENTER** now starts the program. By default we do not have this feature turned on.

### 4.4.14 E-bd: Error Board Temperature

This allows you to set how hot the room can be that the kiln is in before the DynaTrol shuts the elements off. A temp sensor right on the electronic board inside the control box senses temperature and can be used to trigger a power-off to the elements if the kiln room gets too hot. 250°F is the max. Remember it is a whole lot hotter that close to the kiln than it is in the rest of the room. Default setting is 200°F (93°C)

### 4.4.15 REST: Restore Default USER Programs

The DynaTrol comes preloaded with 6 special programs in the VARY-FIRE USER memory slots. VARY-FIRE has 6 memory slots for you to create and store your own custom programs. When it comes to you from the factory however, it already contains programs that as you create your own, you will program over. You may decide to keep these original programs or program over them with your own programs.

If you ever want to get all of the original programs back again, you can go to **REST** in the Hidden Other Menu and press **ENTER**. If you do this however, any custom programs you made up and saved in the VARY-FIRE USER memory slots will be unretrievable. If you want to just get some of the original programs but not others, you will have to manually enter them in. VARY-FIRE TEMPERATURE PROFILES section in the Appendixes contains the actual segment-by-segment program for each of the preset programs.

### 4.4.16 ERTF: Stores the Temp, Hours Past, and Rate of Rise when an Error Code occurs.

This feature stores the temp, number of hours that have passed in the program, and the rate of rise of the kiln when an error code occurs. If you come in to your kiln and see **E- 1** for example, it has shut off because it cannot climb faster than the slowest allowable temp: 12 degrees per hour. You can press **ENTER** and then go to **ERTF** in the Hidden Other Menu, press **ENTER** there and see, the temperature at which the error code happened, then the number of hours and minutes that have passed since the program began, then the actual rate of rise in degrees F/ hour (or degrees C/ hour if yours is set for Celcius) when the error code occurred. This is a great diagnostic tool.

### 4.4.17 COOL: Cone-Fire Cooling Segment

This feature allows the user to toggle **ON** or **OFF** a cooling segment for any EASY-FIRE Program. **OFF** means that the EASY-FIRE Program will fire to its maximum temperature, then shut off and cool naturally. **ON** means that once the max temp is reached the cooling segment will kick in. If **ON** is set, when a EASY-FIRE Program is chosen, like **Slow Bisque**, the control will prompt you

## DYNATROL REFERANCE MANUAL (Blue 700- Rev 5.0)

to enter the cool down segment you want after you are done programming the EASY-FIRE Program.

With this feature turned on, the prompt while you are programming an EASY-FIRE program will be **RA Δ**. When you see this enter a ramp rate. Then you will see **°F Δ** (or **°C Δ**). Enter a final set point temperature that you want the controlled cooldown to stop at. Then you will see **HLDΔ** for a hold time (typically not used). An example of a good cool-down segment would be: **Rate: 150 degF/hr, to: 1200F, hold: 0.**

### 4.4.18 VOLT: Voltage Measurement

This feature allows the line voltage to be tested by the DynaTrol safely, where the kiln is set up. This will help diagnose firing problems where the kiln cannot reach temperature. When you see **VOLT** in the Hidden Other Menu, press **ENTER** and the display will flash **NOLD**; meaning that the next number displayed will be the “No Load Voltage”. Press **ENTER** again and **FLLD** will flash meaning the next number to appear will be the “Full Load Voltage”. The kiln’s heating elements will be turned on for about 4 seconds while the full load voltage is displayed. After that, it will return to **IDLE**

To display voltage using the kiln controller a calibration must be done. Before calibration make sure the relays and elements are connected.

1. Press **Other** key one time. The message **RSET** will be displayed.
2. Type in key sequence **4, 4, 3**
3. **NΔTC** will be displayed. Press **Other** until **VOLT** is displayed.
4. Press **ENTER** key. **NOLD** for no load will be displayed for two seconds. After **NOLD**, a number will be displayed until either **ENTER** is pressed or the **443** calibration code is entered. This number is the no load voltage. However, until after calibration this number is meaningless.
5. Type in key sequence **4, 4, 3**.
6. **CAL1** will be displayed. Measure the line voltage and enter this number now using the keypad. This number will be used to calculate no load voltage
7. Press **ENTER** key.
8. **CAL2** will be displayed. Measure the line voltage and enter this number now using the keypad. This number will be used to calculate full load voltage.
9. Press **ENTER** key.
10. The voltage calibration routine is now complete. The controller will return to idle.

### 4.4.19 DTCT: Amperage Measurement Setting

This feature can only be used if your DynaTrol came with the optional current sensor. If equipped and properly installed, this sensor allows the DynaTrol to read the amperage of the kiln in real time. This setting here only controls the maximum amount that the current sensor will measure. It is set in the factory for the proper amount and should not have to be changed. The amperage reading requires a current sensor that clips around one of the power cord’s hot wires. The default range for the calibrated sensor is 50A. For larger kilns the controller can be adjusted for a higher range sensor.

# DYNATROL REFERANCE MANUAL (Blue 700- Rev 5.0)

## Installing the optional current sensor:

The current sensor has two wires that need to be connected to the circuit board. One wire is black. One wire is white. On the top left corner of the circuit board is a terminal with inputs marked black and white.

1. Insert the white wire in the terminal that has been marked white.
2. Insert the black wire in the terminal that has been marked black.
3. Use a screwdriver to tighten the two screws on the terminals so that the wires will not come lose.
4. The circuit sensor clips around one of the power cord's hot wires.

The control is now able to measure the amperage draw using the controller's diagnostic routines.

## 4.4.20 Amperage Measurement

Amperage measurement can only be done if your kiln is equipped with a current sensor. If there is no sensor (or no amperage), your amp readings will be 0 when you run try this feature.

To run this feature first enter the "Hidden Other Menu", then scroll through it until you come to **dIAG**. Press **ENTER** and see it say **OUTS**. Press "1", see it say **AMPS**. Press **ENTER** and see it say **AMP1** -meaning the next number displayed will be the amps of Zone 1. Then **AMP2** will be displayed- meaning the next number to appear will be the amps of Zone 2, and so on for Zone 3 if you have three zones.

## **APPENDIX A**

### **OVERVIEW OF FEATURES**

#### **A.1 Dynamic Zone Control**

The DYNATROL features Dynamic Zone Control. It measures temperatures in the bottom, middle and top of the kiln and automatically adjusts the heat output of three separate heating zones even as the kiln is heating up and during the final approach to maturing temperatures. Kiln temperatures are automatically evened out to within 1/2 cone or better top to bottom! There is no manual intervention with input switches to even out temperatures. There are separate thermocouples (heat sensors) and contactors (power controls) for each of the three zones. Dynamic Zone Control suspends firing on one or more zones if the other zones are lagging behind the faster zone(s). **TC1** (as displayed on the kiln) is the Top Zone, **TC2** is the Middle Zone, **TC3** is the Bottom Zone.

**NOTE: It is absolutely necessary to match the proper section with the proper control box outlet and proper thermocouple** (Thermocouples, cords and receptacles are all marked for identification. If these are mismatched the kiln will not operate properly and you will get the **Ed** display showing that one of the zones is way off set point.

#### **A.2 Programmable Number of Zones**

The latest version of the DynaTrol allows you to program the number of zones. Typically there are three zones in a kiln. However, on our two section kilns the control will come programmed to operate as a two zone control. On GS1714 kilns we have the control programmed to be a single zone control. If you change the number of sections in a kiln (for instance, if you take one section off a three section kiln) you can reprogram the control to suit your needs. Another benefit of this new feature is that you can program the control to be a single zone control and avoid the complications of three zone control (i.e. LAG issues). When the control is programmed to be a single zone control outputs 1, 2 and 3 all work together. When programmed as a two zone control outputs 2 and 3 work together and output 1 is separate.

## A.3 Four Easy Preset Programs

There are four preset “EASY-FIRE” programs that have been designed to do most typical ceramic firing cycles. They are **Fast Bisque**, **Slow Bisque**, **Fast Glaze** and **Slow Glaze**. These preset programs have specific ramps and speeds built into them (see Appendix A for details of what these ramps are). You can enter any cone number up to cone 10\* as a final temperature, a hold time, a delay time and even a time as options. This allows a great deal of customization while still keeping the programming simple and easy. We recommend you start with these programs until you get some experience with the control and your kiln.

The EASY-FIRE mode uses Orton’s patented method to achieve correct heat work so it is ideal for firing ceramics. The advantage of using the EASY-FIRE method is that a very complicated firing profile may be chosen with just a few key strokes. The EASY-FIRE method helps protect against over and under firing by carefully tracking and controlling the temperature at the end of the firing as the cone temperature is approached. The program is based on a 108°F temperature rise for a large self supporting cone (rather than the small Orton cones or regular large cones).



\***Note:** Some L&L Kilns are not designed to go to cone 10. Consult your kiln’s label for the maximum operating temperature.

TIP

## A.4 Six User Defined Programs

If your needs are more sophisticated or involved there is a separate VARY-FIRE programmer mode. This allows you to have 6 separate, repeatable, storable programs with up to 8 segments. There is one cooling or heating ramp, a temperature setpoint and an optional hold time per segment. The programs are stored in non-volatile memory which means that they will stay in memory even when all power is turned off. The DYNATROL allows you to soak at a low temperature for a long time (i.e. you can have an automatic drying period) and then automatically ramp up to your high fire at different rates. You can ramp slowly through critical periods or soak at end point temperatures for more consistent maturing of work. It also allows a controlled cool down to avoid heat shock. Of course many of these valuable uses are available in the preset EASY-FIRE programs. However, with the VARY-FIRE programs you have complete control over ramp times and rates and so you can adjust the kiln performance to your exact needs. It also allows the control to be used for non-ceramic applications such as glass, enameling, heat treating and other industrial uses.



**Note:** VARY-FIRE programs fire the kiln to your specifically programmed temperature. EASY-FIRE programs will fire the kiln to your specifically programmed cone number.

TIP

## A.5 Linkable Programs

You can link VARY-FIRE Program #5 and #6 to get a 16 segment program. You can also use this system to link VARY-FIRE Program #6 to the end of an EASY-FIRE Program.

## A.6 Delay Start

You can delay the start of the program by up to 99 hours, 99 minutes. This allows you to plan end of firing conveniently. This is also very useful for saving energy costs by firing kiln with night electric rates. If you want the kiln to mature at 2:00 PM the next day and you know your program will take 12 hours and you are starting your program at 4:00 PM today you would program in an 8 hour delay. **NOTE:** The delay start remains on or set for all programs (both VARY-FIRE and EASY-FIRE) until you turn it off.

## A.7 Preheat (Candling)

You can “candle” the kiln for up to 99 hours, 99 minutes to dry ware thoroughly. “Candling” is a specific hold at 200°F which boils off the water in the clay slowly so that your work does not explode as the water expands rapidly to steam. This is highly recommended to do for most ceramics. We recommend overnight or for at least several hours depending on how dry your work

## DYNATROL REFERANCE MANUAL (Blue 700- Rev 5.0)

it. NOTE: This is available as an optional step in the EASY-FIRE mode only. You can do the same thing with an added first segment in the VARY-FIRE mode.

### A.8 Soak

The control will soak at Final Set Point for up to 99 hours, 99 minutes, and can be programmed to hold a temperature as long as 66 days before needing to be reset. This is a very useful feature and one of the great advantages of an automatic control. Most ceramics achieve their characteristics not so much by what temperature they reach but by how much “heat-work” is put into them. A long soak at a lower cone can often develop the bisque or glaze better. In addition a soak period almost always will improve the uniformity of the firing throughout the kiln. A soak period gives the entire load of ware time to absorb the radiant heat that is projected from the elements. If you simply rise to a certain temperature and then shut the kiln off (as is typical of a manual kiln sitter operation) then the center or the bottom of the kiln may not have had a chance to absorb as much heat as the ware around the perimeter. You may have experienced the fact that an older kiln with slow firing elements may in fact have given you better results. This is because the entire kiln has had a chance to even itself out as it approached final cone. We suggest experimenting with this feature. Try a soak of 10 to 20 minutes. The Dynatrol will automatically adjust the final temperature to compensate for the programmed Hold Time in the EASY-FIRE mode only. Be warned that element life is lessened by the amount of time the elements spend up at a higher temperature.

### A.9 Audible Temperature Alarm

There is an easily settable audible temperature alarm. This can alert you at any point in program. For instance the control can alert you that the kiln is close to maturity so you can watch it reach final set point. You can use it to alert you when to close the lid if you are manually venting the kiln. You can disable this alarm by programming in 9999. Press **ENTER** to turn off alarm when it is sounding. You can tie this into a relay output to ring an external alarm. (See section 4.4.9).

### A.10 Program Review

Press this button to see the entire program before or while running it. It will scroll through the programmed steps. We suggest hitting **Review Prog** at the beginning of your firing to see if the control is set up to do what you want it to. If the control shows error codes “OFF” when they should be “On” or no “Hold” where one should be, you must first stop the program that is running in order to change anything. Most settings cannot be changed while running a program.

### A.11 Segment Review

Press **Review Seg** once while you are firing to see which segment’s ramp or hold you are currently in, what the current set point is, and what the actual temperature of the Dynatrol’s electronics are.

### A.12 Skip Segment

In the VARY-FIRE mode you can skip a segment to advance to a higher segment and speed the program along.

### A.13 Set Point Indication

If you press **Review Seg** twice while the kiln is firing, the control will show you what your current set point is during the program as it is changing. This is useful to confirm that the temperatures of the thermocouples are where they are supposed to be.

### A.14 Change of Program During Firing

When firing you can alter the program anytime. You must press **START/STOP**, then reprogram, then press “Start”. The Dynatrol will automatically take the current temperature into consideration and start back up at that point in the program. If you attempt to do this right at the end of a firing, the amount of time it takes to reprogram is not accounted for by the Dynatrol. If more than a few

## DYNATROL REFERANCE MANUAL (Blue 700- Rev 5.0)

minutes go by, the temperature displayed may not accurately represent the amount of heat work taking place in the kiln. Another reason to fire with witness cones.

### A.15 Cone Offset

This is one tool you have to help you match the control to your real firing experience. It is important to fire the kiln with witness cones to find out what is really happening inside the kiln. Using these you can fine tune the overall performance of the kiln to match what is really happening to your ware. The cone offset is just one of the ways you have of making this adjustment. Keep in mind however that your firing speed and soak time will also have an effect on how the witness cones and ware perform. When you are making an adjustment try changing one variable at a time. For instance if you are firing to Cone 05 and your witness cones don't mature you could do a number of things. One is to use the cone offset to raise what the Dynatrol thinks is the temperature of cone 05 in an EASY-FIRE program. Another thing you could do is put in a soak/hold time at the end of the program in a VARY-FIRE program. Another thing would be to slow the kiln down towards the end of its firing cycle with a slower, longer final segment in a VARY-FIRE program. Try one thing at a time to find out what works best for you. The cone table that the Dynatrol uses are based on a 108°F temperature rise for a large self-supporting cone (not the small Orton cones or the regular large cones).

### A.16 Thermocouple Offset

This allows you to individually change what the Dynatrol thinks the thermocouples are reading. Use this to adjust for thermocouple drift or kiln uniformity adjustments. It allows you to influence how the kiln "sees" the temperature in the kiln. For instance, if the center zone is consistently firing higher (as measured by witness cones) then you would change that thermocouple to read higher. This would trick the control into thinking that the center zone was hotter and it would keep the temperatures down. The difference between Cone Offset and Thermocouple Offset is that Cone Offset works in EASY-FIRE programs only and changes a specific cone's temperature for the whole kiln. Thermocouple Offset will affect temperatures in both VARY-FIRE programs and in EASY-FIRE programs. Basically it changes just that particular thermocouple's reading up or down to even out temperatures in an unevenly heating kiln no matter what cone number or temperature you are firing to.



**NOTE:** Thermocouples drift in their accuracy over time. The hotter you fire the quicker this will occur. This is another reason why it is important to check each firing (or at least every 5 or 10 firings) with witness cones. This is particularly important if you are firing at high temperatures like cone 6 or cone 10.

### A.17 Last Temperature Reached Indication

When an EASY-FIRE program is complete it will tell you what the last temperature reached was. You press **Review Prog** at the end of the cycle to see this temperature. This is useful for logging and comparing to what happened with your ware. Compare this temperature to witness cones and make adjustments in your firing cycle or cone offsets to adjust the performance of the kiln.

### A.18 Cone/Temperature Equivalent Look Up Table

Convert cone numbers to temperatures in degrees. The look up table is based on a ramp rate of 108°F. This table is provided as a handy reference table to use while you are programming. There is a more complete table in the Appendix J.

### A.19 Dust Sealed Keypad

The keypad is dust tight so you don't need to worry if you have dirty hands that might get dust into the electronics.



## **DYNATROL REFERANCE MANUAL (Blue 700- Rev 5.0)**

### **A.20 Easy to Follow Graphic Design**

It is graphically designed to be user friendly. EASY-FIRE, VARY-FIRE, OPTIONS and VIEW functions are grouped separately. The numeric keypad makes entering parameters like temperatures and cone numbers easy.

### **A.21 Error Checking Can Be Turned Off**

There are various error codes in the control. These can be important diagnostic tools. They can also be somewhat confusing and alarming if you don't understand them. One of the most common ones is **E 1** which will stop the program if the kiln's temperature is rising too slowly. **ErrP** flashing or **PF** indicates a power outage to the control. **E d** indicates that one zone is 100°F off set point. All these and more are explained in greater detail in Appendix G.

### **A.22 Reset Defaults Function**

This function (available under "Options, Other" - see Section 4.3.3) resets most settings back to factory defaults. It does not affect the thermocouple or cone offsets. Turns Error Checking On.

### **A.23 Reads Control Board Temperature**

This is a diagnostic tool. The control should not be operated when it is above 125°F ( 52°C) or below 32°F (0°C). This should not normally be a problem with the way L&L mounts these controls away from the heat. However, if you do get a reading that is higher than this temperature (for instance if you are operating in a particularly hot room) we recommend that you direct some cooling air at the control. This board temperature is displayed as follows: When you press the View Segment Button while firing, first the current segment is displayed, then the set point temperature and then the Dynatrol's board temperature. Ambient temperatures that are out of the suggested range can lead to either control failure or control inaccuracy.

### **A.24 Automatic Restart after Brief Power Interruption with Flashing Alert**

This is the **ErrP** indication. If the power outage was brief the program will continue to fire and the **ErrP** message will flash with the temperature indication. By hitting the "1" button you can clear this alarm message. See Appendix G for all error code explanations

### **A.25 PID Tuning Control**

PID stands for Proportional - Integral - Derivative. It is a sophisticated calculus algorithm that minimizes temperature overshoot. The control is able to anticipate the temperature set point and start to cut back power before it reaches actual setpoint. In standard On/Off control the power does not turn off until the actual set point is reached. Because of the inertia of the kiln this could result in temperature overshoot without the PID control. The values for the PID are hard programmed into the control and can not be changed. They are optimized for ceramics. If you are using the control for another application and you find that the control gives you some overshoot try a step in your VARY-FIRE program that is a very slow ramp for the last few degrees of the program. For instance if you wanted to get to 1800°F without overshoot, have the program go to 1775°F and then take 15 minutes to ramp to 1800°F. NOTE: As of April 2000 a second set of PID settings was added for temperatures below 500°F. This improved overshoot in the lower temperature range.

### **A.26 Thermocouple Burnout Protection**

The kiln will shut down automatically if all thermocouples burn out. The kiln continues to fire if only one or two thermocouples burn out. This protects your firing in the event of failed thermocouples. Of course, if all three thermocouples fail then the control stops firing.

### **A.27 Digital Indication of Temperature in either Degrees F or C**

You can switch between temperature readings in degrees Fahrenheit or degrees Centigrade.

## **DYNATROL REFERANCE MANUAL (Blue 700- Rev 5.0)**

### **A.28 See All the Zone Temperatures**

You can scroll through all three thermocouple readings by pressing **1** to see **TC1** (top zone), **2** to see **TC2** (middle zone) and **3** to see **TC3** (bottom zone). The default view is of **TC2**. You must specifically hit **1** or **3** to see the top and bottom zone temperatures. The reading will stay on the thermocouple that you last pressed.

### **A.29 See Which Zones are Firing**

Press Number Key **8** while the kiln is firing. This toggles the LED display to show you which zones are firing. See the section under **DESCRIPTION OF KEY FUNCTIONS AND DISPLAY**, Appendix C for details. This is a great diagnostic tool to allow you to see which zones are firing. For instance if one zone is firing constantly and the other zones are not then you know that the constantly firing zone is the slow zone.

### **A.30 See the current rate of rise in degrees per hour:**

Press Number Key **5**. See the section under **DESCRIPTION OF KEY FUNCTIONS AND DISPLAY**, Appendix C for details

### **A.31 See the elapsed time since the firing began**

Press Number Key **0**. See the section under **DESCRIPTION OF KEY FUNCTIONS AND DISPLAY**, Appendix C for details

### **A.32 Cold Junction Compensation**

The control automatically compensates for varying ambient temperatures. It can operate in ambient temperatures of 32°F to 125°F (0°C to 50°C). The **Review Seg** button lets you see ambient board temperature (press **Review Seg** three times). This is an electronic compensation.

### **A.33 Matches Pyrometric Cone Performance in EASY-FIRE Mode**

This feature is licensed from Orton. (Patent #4,461,616 and 4,730,101). This feature is not controlled by the user. Basically it adjusts how the firing takes place towards the end so that the control approximates how cones work. The control sees how fast the kiln is rising and adjusts the final end point temperature higher or lower to achieve the proper amount of “heat-work”. For instance, to mature your ware at the same cone number, a the kiln rising at 100°F per hour will require a lower set point temperature than a kiln rising at 200°F per hour. This feature is only used in the EASY-FIRE mode. Note: The control emulates the self supporting cones. (see Appendix J, Pyrometric Cones)

### **A.35 Computer Interface System**

The new DynaTrol is capable of being hooked up to a computer using special KISS Software. See separate instructions for details on this feature. Up to 10 separate kilns can be hooked up to one computer. This is available from L&L.

## **DYNATROL REFERANCE MANUAL (Blue 700- Rev 5.0)**

### **A.36 PID algorithm**

The PID algorithm (in industrial, mathematical terms this is the proportional, integral, and derivative functions of the control) is how the controller decides what percentage of the kiln's total power is required to keep the temperature at the desired set point. The DynaTrol 700 board has a cycle time of 14 seconds (as the default setting) and will turn the relays on for a calculated number seconds to give the correct percent of power needed to keep the temperature near the traveling set point. For example, if the controller calculates that 25% of the power is required, the relays will be on for 3.5 seconds and off for 10.5 seconds.

Each part of the P (Proportional band), I (Integral) and D (Derivative) are calculated separately and added together to determine the correct percentage (control value) of power required. The proportional part of the control value is based on how far the temperature is away from the desired set point. It is the difference between the set point and the current temperature (also called the error) multiplied by the proportional gain.

The integral part of the control value is based on how long the temperature is taking to get to the set point. It is calculated by multiplying the error by the integral gain and summing this value over time. The integral value compensates for any long term error not taken care of by the proportional part.

The derivative part of the control value is based on how fast the temperature is moving towards or away from the set point. If the temperature is moving quickly towards the set point the derivative portion reduces the control value to prevent overshoot. If the temperature is moving away from the set point then the derivative portion increases the control value to get the temperature to start moving back towards the set point.

The constants for calculating the control value are fixed within the controller and can not be changed by the user. They do vary throughout the firing depending on the current temperature in the kiln. To prevent over and undershoot, the controller also has "approach control" to smooth the transition from a fast ramp to a hold.

### **A.37 Automatic Lag Function**

With a zone control kiln there is always a trade off between speed and tightness of control. The series 700 automatic control LAG feature uses the programmed ramp rate to automatically set its "LAG" temperature setting to balance these two opposing needs. Sometimes the temperature of one or more kiln's sections "lags" behind one or more of the other sections. This is because the traveling set point of the control (based on the programmed ramp rate) is faster than one or more of those sections' can rise and have the temperature in the sections stay even. To effectively deal with this the 700 DynaTrol will automatically slow the ramp rate when a section of the kiln lags. The amount of "lagging" that is allowed before the firing rate will slow is determined by the ramp rate. Fast ramp rates (greater than 500 °F/hour) will allow the greatest temperature difference between sections. Slow ramp rates (below 70 °F/hour) will have the smallest temperature difference between sections. Therefore, when the controller is programmed to go fast it will sacrifice evenness to obtain speed. Likewise, when the controller is programmed to go slow, the controller will maintain tighter control. The controller will try to balance speed and tight control when a medium speed is programmed.

## **DYNATROL REFERANCE MANUAL (Blue 700- Rev 5.0)**

Here is the actual algorithm for those of you who are interested in knowing what is taking place (note that this is all transparent to the user and is included in here to let you know how this works):

- 1. If the programmed rate of rise is between 1°F/hour and 70°F/hour and -**
  1. all thermocouple readings are less than 3 degrees behind the traveling set point, the traveling set point moves at the programmed rate.
  2. the lowest thermocouple reading is between 3 and 6 °F behind, the traveling set point moves at 75% of the programmed rate.
  3. the lowest thermocouple reading is between 6 and 9 °F behind, the traveling set point moves at 50% of the programmed rate.
  4. the lowest thermocouple reading is between 9 and 12 °F behind, the traveling set point moves at 25% of the programmed rate.
  5. the lowest thermocouple reading is more than 12 °F behind, the traveling set point moves at 1 degree F per hour.
  
- 2. If the rate of rise is between 71°F/hour and 500°F/hour and -**
  1. all thermocouple readings are less than 7 degrees behind the traveling set point, the traveling set point moves at the programmed rate.
  2. the lowest thermocouple reading is between 7 and 14 °F behind, the traveling set point moves at 75% of the programmed rate.
  3. the lowest thermocouple reading is between 14 and 21 °F behind, the traveling set point moves at 50% of the programmed rate.
  4. the lowest thermocouple reading is between 21 and 28 °F behind, the traveling set point moves at 25% of the programmed rate.
  5. the lowest thermocouple reading is more than 28 °F behind, the traveling set point moves at 1 degree F per hour.
  
- 3. If the rate of rise is greater than 500°F/hour and -**
  1. all thermocouple readings are less than 10 degrees behind the traveling set point, the traveling set point moves at the programmed rate.
  2. the lowest thermocouple reading is between 10 and 20 °F behind, the traveling set point moves at 75% of the programmed rate.
  3. the lowest thermocouple reading is between 20 and 30 °F behind, the traveling set point moves at 50% of the programmed rate.
  4. the lowest thermocouple reading is between 40 and 50 °F behind, the traveling set point moves at 25% of the programmed rate.
  5. the lowest thermocouple reading is more than 50 °F behind, the traveling set point moves at 1 degree F per hour.

**APPENDIX B**

**DESCRIPTION OF KEY FUNCTIONS AND DISPLAY**

The front panel of the controller has seven distinct parts:

- **START/STOP** Key
- **LED** Display
- **VARY-FIRE PROGRAMMER** Section
- **REVIEW AND SPECIAL OPTIONS** Section
- **NUMBER KEYS** Section
- **EASY-FIRE** Section
- **EASY OPTIONS** Section

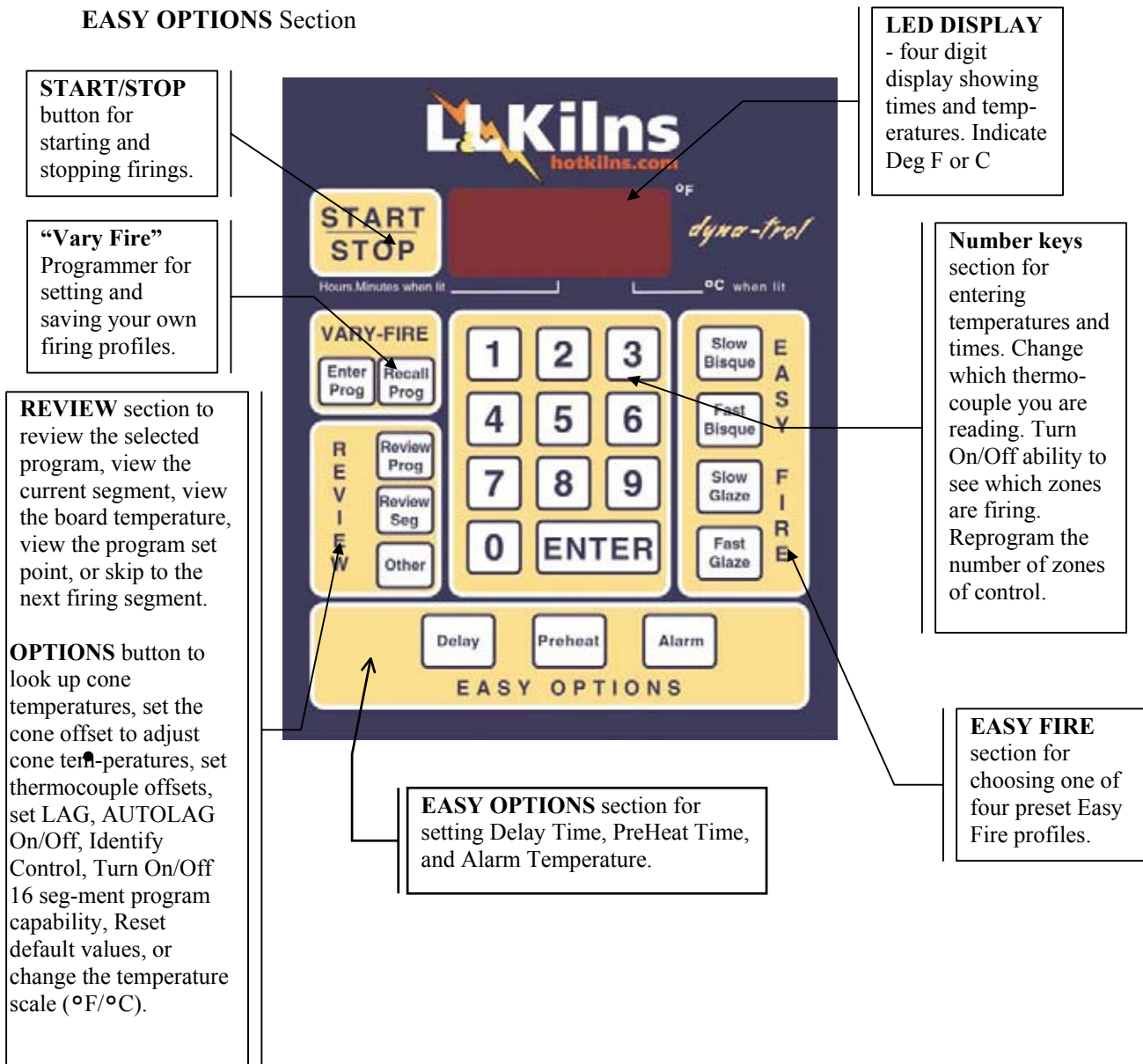

# DYNATROL REFERANCE MANUAL (Blue 700- Rev 5.0)

## B.1 START/STOP Key



Starts the firing or, if there is a firing in progress, stops the firing.

**NOTE: This key has no function during programming.**

## B.2 VARY-FIRE PROGRAMMING Section

Program your own firing profiles and recall them for use.



**Enter Prog** - This button allows you to initiate programming. Up to 6 profiles (programs) may be programmed and saved.

**Recall Prog** - Allows one step recall of one of the programmed profiles (programs).

## B. 3 LED DISPLAY- Displays temperatures, times, and messages.

The LED (Light Emitting Diode) has room for four digits or letters in the display.

When the decimal point is displayed between the middle 2 digits, a time is being displayed.

If there is a decimal to the right of the last digit, the temperature is being displayed in degrees Celsius (Centigrade). By pressing #8 on the numerical Keypad while you are firing a profile you can turn on and off the ability to see which zones are firing. The little LED lights under the numerals in the display act as indicators of the zones firing. There are three of these little indicators and all three will blink on and off even if your kiln only has two or one heating zone

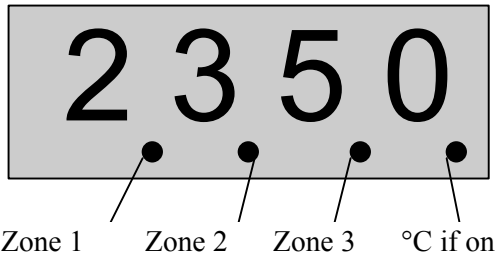

# DYNATROL REFERANCE MANUAL (Blue 700- Rev 5.0)

## B.4 REVIEW & SPECIAL OPTIONS

Cone Offset, Thermocouple Offset, Identify Control for KISS software, Set 16 Segment Program, View Cone Table, and change between °F and °C.

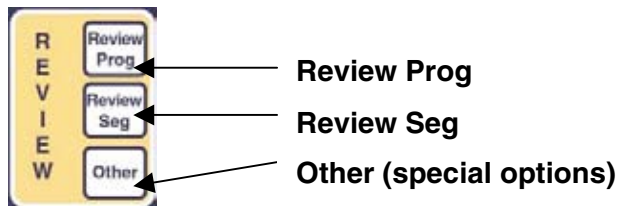

**Review Program** - The information displayed when Review Program is pressed varies depending on whether you are using EASY-FIRE or VARY-FIRE. When Review Program is pressed, each of the steps in the current firing profile is displayed one after another.

When a firing is complete, Review Program is used to see the final temperature reached during the firing.

**Review Segment** - It is used to view the current firing segment or to skip from the current segment to the next segment. When Review Segment is pressed during a firing the current stage of the firing is displayed. If it is pressed in between firings, **STOP** will flash and then the current temperature will be displayed. When you press **REVIEW SEG** twice you will see the program set point temperature. When you press it three times you will see the control board temperature.

**Other** - There are several “Other” options

- Reset feature **RSET**
- Cone Lookup Table **CONE**
- Controller ID **Id**
- 16 step program **16-S** (only comes up if you have VARY-FIRE Program #5 in active memory or if you have an EASY-FIRE program in active mememory)
- Cone temperature offsets **CNOS**
- Temperature scales **°F** or **°C** **CHG°**
- Error codes **ON** or **OFF** **ERCd**
- Thermocouple offset **TCOS**
- Board temperature **bd T**

# DYNATROL REFERENCE MANUAL (Blue 700- Rev 5.0)

## B.5 NUMBER KEYS Section

Contains the ENTER key and the number keys.



**Numeric keys** - Used for entering times, temperatures and other numbers. The number “1” is also used to acknowledge the **ErrP** error signal when you first turn the kiln on. Press “1”, “2” or “3” while firing to change which thermocouple reading you see in the LED display.

-Press **5** while firing and see the current rate of climbing in degrees per hour. This is useful to look at near the end of the program so you can look on a cone chart to accurately see what temperature your kiln will shut off.

-Pressing the **7** key will run the amperage diagnostic routine displaying the amperage rating for each section of the kiln. If the kiln is not equipped with the optional current sensor all amperage readings will be zero.

-Press **8** while firing to turn On/Off the ability to see which zones are firing by the LED display dots. Dot on the left is the top zone, dot in the center is the center zone, and the dot on the right is the bottom zone. Don’t forget that the dot on the very far right is only on if you are running in Celcius temp scale.

-Press **0** while firing to see how much time has elapsed since the program began

**Enter Key** – Used to enter or acknowledge numbers and programs

## B.6 EASY-FIRE Section

Choose the EASY-FIRE mode you want to use.

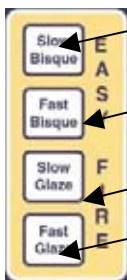

**Slow Bisque** - Used for setting a slow bisque firing profile.  
\*\* ~13 hours to fire to cone 04.\*\*

**Fast Bisque** - Used for setting a fast bisque firing profile.  
\*\* ~10 hours to fire to cone 04.\*\*

**Slow Glaze** - Used for setting a slow glaze firing profile.  
\*\* ~7 hours to fire to cone 04.\*\*

**Fast Glaze** - Used for setting a fast glaze firing profile.  
\*\* ~4 hours to fire to cone 04.\*\*



# DYNATROL REFERANCE MANUAL (Blue 700- Rev 5.0)

## B.7 EASY-OPTIONS Section

Choose the EASY options (Delay Time, Preheat Time, Alarm)



**Alarm** – Used to sound an audible alarm at a temperature that you specify. Pressing the **Alarm** key while firing will allow the reprogramming of the alarm to either a low or high temperature alarm.

**Preheat** – Used to put in a preheat time at 200F to allow the ceramic work to dry out completely.

**Delay** – Used to delay firing until you want the program to start

## **APPENDIX C**

### **TERMS AND ABBREVIATIONS**

**Celsius** - a temperature scale in which 0° is the freezing point and 100° the boiling point of water. Also called centigrade.

**centigrade** - a temperature scale in which 0° is the freezing point and 100° the boiling point of water. Also called Celsius.

**cone** - a pyramid shaped ceramic composite which bends and melts in the kiln to indicate the amount of heat work which has taken place in the kiln.

**default** – (or default settings) These are the settings that the Dynatrol comes programmed with from the factory. Using the Reset feature will return the Dynatrol to it's default settings.

**final set point** – in an all heating program with no cooling segments this would be the maximum temperature the kiln was programmed to reach. If there are programmed cooling or holding segments then the last segment's programmed set point is the final set point.

**profile** - A series of segments which define how the kiln temperature is to proceed through the firing. This is sometimes referred to as a program.

**ramp-hold** - A firing profile in which the temperature is programmed to increase to a specific temperature, hold for a period of time then repeat this sequence until a final temperature is reached.

**segment** - One unit of programming. Each segment on this control has a ramp (Deg per hour), a final set point temperature and a hold time.

**set point** – the target temperature within a programmed segment.

**T/C or t/c** - Abbreviation for thermocouple.

**thermocouple** (abbreviated T/C or t/c) - Temperature measurement sensor made of two dissimilar metals which are joined at one end; the end where they are joined is the temperature measuring end. The RED wire is always the negative lead in a thermocouple.

## **DYNATROL REFERENCE MANUAL (Blue 700- Rev 5.0)**

**witness cone** - a ceramic cone which bends to indicate the heat work which has been done.

## **APPENDIX D**

### **DISPLAY MESSAGES (in alphabetical order)**

**ALRM - Alarm.** When **ALRM** flashes in the display, an alarm temperature between 0° and 9999° may be entered. When the alarm is set to 9999°, it is turned off.

**bd T - Board Temperature.** Indicates the temperature of the Dynatrol's electronics (see Control Precautions).

**°C 1, °C 1, °C 1, through °C 8,** Degrees Celsius temperature. In the VARY-FIRE Mode with the Celsius temperature scale selected, the controller is waiting for an end temperature to be entered for the segment. The numbers stand for the segment which is being programmed.

**CHG° - Change degrees -** When **CHG°** is displayed, press **ENTER** to select the temperature scale you would like to use, either Fahrenheit (°F) or Celsius (°C). The **1** key will toggle between °F and °C. When the scale you want to use is displayed, press **ENTER**.

**CNOS - Cone offset.** Press **ENTER** to adjust an individual cone shut off temperature plus or minus 50°F.

**CONE - Cone number.** When **CONE** is displayed, a cone number between 022 and 10 must be entered. This will be found in the Cone Table or the "EASY-FIRE" Mode.

**°CS-Degrees Centigrade offset –** seen when a Cone Offset or a Thermocouple offset is being programmed.

**CPL - Complete.** Indicates programming or some programming function is complete.

**CPLT - Complete.** Indicates a firing has been completed.

**Decimal Point displayed in lower right-hand corner of display** The temperature is displayed in degrees Celsius (°C).

**Decimal Point displayed in center of display between 10's and 100's.** A time in hours and minutes is being displayed.

**dELA - Delay.** Indicates the time in hours and minutes before the start of firing.

**DIAG - Diagnostics.** Located in the Hidden "Other" Menu. Pressing **ENTER** here turns zone 1's elements on for a few seconds followed by zone 2's elements, then zone 3's elements. A powered bottom will stay on during all three zone's test. If the kiln is improperly put together it will become apparent now.

**ERCd. Error Codes.** When **ErCd** is displayed, press enter to turn the Error Code function on or off. This function is located by pressing **Other** in the OPTIONS Section.

**E A Error.** Indicates a software error has occurred. The error codes are listed in **APPENDIX**.

**E E.** Software Error. Indicates a software error has occurred. Contact L&L Service. The error codes are listed in **APPENDIX**.

**E 0, E 1, E 2 through E 8** means **Error**. An error has occurred; the error codes are listed in **APPENDIX**.

**ErrP (flashing)- Power Outage Error.** This is displayed during a firing if power to the kiln has been interrupted for less than a couple minutes, depending how far along in the firing you are. The error codes are listed in **APPENDIX**.

## DYNATROL REFERANCE MANUAL (Blue 700- Rev 5.0)

**°F1, °F2, °F3** through **°F8** In the VARY-FIRE Mode with the Fahrenheit temperature scale selected, the controller is waiting for an end temperature to be entered for the segment. The numbers stand for the segment which is being programmed.

**°F0S - Degrees Fahrenheit Offset** – seen when a Cone Offset or a Thermocouple offset is being programmed.

**FAIL - Thermocouple Failure.** The thermocouple is not connected to the controller or there may be a break in one of the thermocouple lead wires. If the thermocouple wire is broken, it must be replaced. When connecting the thermocouple, SEE THE COLOR CODING INFORMATION in Section 1.0 (Control Cautions).

**FAN1, FAN2, FAN3,** through **FAN8** - This message will appear during programming in the VARY-FIRE mode only after OP C (option C in the hidden “other” menu) has been chosen. “FAN” refers to your powered bottom (if you have one), and the number is the number of the segment you are currently programming. The powered bottom (FAN) can be programmed to be **ON** or **OFF** in each segment of the VARY-FIRE program.

**F-bC Fast Bisque,** One of the EASY-FIRE programs

**F-GL Fast Glaze,** One of the EASY-FIRE programs

**H0Ld** or **HLd** - **Hold.** Indicates the holding time in hours and minutes at the end of a “EASY-FIRE” program. OR it may mean that you have just chosen the Preheat option and now the Dynatrol is asking how much hold time in the preheat setting you want to have.

**HLd1, HLd2, HLd3** through **HLd8** In the VARY-FIRE Mode the controller is waiting for a soak or hold time in hours and minutes to be entered for the segment. The numbers stand for the segment which is being programmed.

**Id – Identification.** Allows you to identify a particular control for use with KISS computer software.

**IdLE and Temperature – Flashing** The kiln is off, and the current temperature in the kiln is displayed. The Dynatrol is programmed to run using only one thermocouple.

**IdLE, TC2, and the current temperature flashing-** The kiln is off, and the current temperature in the kiln at thermocouple #2 is displayed. The Dynatrol is programmed to run using either two or three thermocouples.

**NOtC - Number of thermocouples.** Located in the Hidden “Other” Menu. Pressing **ENTER** here allows you to choose how many thermocouples (essentially how many zones) are in the kiln.

**OFF.** Press **ENTER** when displayed to turn the Error Codes, the Autolag, a Powered Bottom, or the “shut off” feature Off. Pressing the **1** key toggles between **On** and **OFF**.

**ON** (no dashes). Press **ENTER** when displayed to turn the function you are programming on. Pressing the **1** key toggles between **On** and **OFF**.

**-On-** (displayed with dashes). Displayed for about 10 to 15 seconds when the **START/STOP** button is pressed to begin a firing. The heating elements of the kiln will not begin heating until **-On-** disappears and the current kiln temperature is displayed. NOTE: Pressing any key besides **START/STOP** while **-On-** is displayed, will stop the firing. Pressing **START/STOP** after **-ON-** goes away will stop the firing.

**OPA. Option A.** DO NOT PRESS ENTER HERE. This option is not used with L&L’s kiln systems.

## DYNATROL REFERANCE MANUAL (Blue 700- Rev 5.0)

**ØPB. Option B.** DO NOT PRESS ENTER HERE. This option is not used with L&L's kiln systems.

**ØPC. Option C.** Located in the Hidden "Other" Menu. Allows you to turn the powered bottom on or off in each segment of the VARY-FIRE mode.

**PCT. Percent.** Located in the Hidden "Other" Menu. You can set how often your powered bottom comes on based on a percent of when the bottom zone comes on.

**PF. Power Failure.** PF indicates the power to the kiln has been interrupted for a long enough time to effect the current firing. The kiln has shut down and the firing must be restarted.

**PIØ.** Located in the Hidden "Other" Menu. Pressing **ENTER** when you see this allows you to program a setting to help a heavily or unevenly loaded kiln fire faster.

**RA1, RA2, RA3 through rA8** In the VARY-FIRE Mode the controller is waiting for an ramp temperature rise per hour to be entered for the segment. The numbers stand for the segment which is being programmed. The temperature is in °F/hr or °C/hr whichever has been selected. If °C has been selected, there will be a decimal point in the lower right-hand corner of the display.

**RSET Reset.** Press **Other** until **rSEt** is displayed. Then press **ENTER**. **IDLE** will be displayed indicating that the the Error Checking is **ØN**. This is the Default settings.

**16-S. Sixteen step program option.** VARY-FIRE profile #5 must have been chosen, and now the Dynatrol must be told whether to automatically fire VARY-FIRE profile #6 immediately after the ending of #5 (16-S set to ON) or not (16-S set to OFF).

**SAFT. Saftey option.** DO NOT PRESS ENTER HERE. This option is not used with L&L's kiln systems

**S-bC Slow Bisque.** One of the EASY-FIRE programs

**S-GL Slow Glaze,** One of the EASY-FIRE programs

**SEG. Segment.** When **SEG** is displayed, the number of desired segments for a VARY-FIRE program should be entered.

**SHTØ.** Located In the Hidden "Other" Menu. Set to either **ØN** or **ØFF**. Lets you choose between firing styles where: **ØN** means that as soon as the hottest zone gets to the segment's set point the entire kiln switches to either the "hold time" or the next segment. **ØFF** means that the Dynatrol will not let the hottest zone's temperature rise until the average temperature of the three zones reaches that segment's set point. Then the kiln can begin the "hold time" or the next segment.

**STOP - Stop.** Indicates firing has been stopped. Also may be displayed when the controller is first turned on. Also used like **CPL** with some functions.

**USER.** When **USER** is displayed, one of the 6 user programs may be selected or programmed.

**SSTP. Skip Step.** Press **Review Seg, ENTER, ENTER** to skip to the next ramp segment in a VARY-FIRE program. Skip Step is not available with a EASY-FIRE program.

**TCØS Thermocouple offsets.** This is used to raise or lower the temperature indicated by any of the thermocouples. The maximum offset is 50°F. A positive offset is entered with 00 preceding the amount of offset and a negative offset is preceded with 90. This is the same as is done for entering cone offsets. When **TCØS** is displayed, press **ENTER** and **TC1** will be displayed. Press enter and the current offset for the top thermocouple will be displayed. Press **ENTER** when the correct offset for the top thermocouples is displayed and then **TC2** will be displayed. Repeat the process for **TC2** and **TC3**.

## **DYNATROL REFERANCE MANUAL (Blue 700- Rev 5.0)**

**Temperature - Continuously displayed** The kiln is on (in either a VARY-FIRE or a EASY-FIRE program), and the current temperature in the kiln is displayed. The Dynatrol is programmed to run using only one thermocouple.

**TC2 and the current temperature flashing-** The kiln is on (in either a VARY-FIRE or a “EASY-FIRE” program), and the current temperature in the kiln at thermocouple #2 is displayed. The Dynatrol is programmed to run using either two or three thermocouples.

**Time - Decreasing** A delay start is in effect for a VARY-FIRE or a EASY-FIRE program. The time remaining before the kiln starts to heat is displayed.

**Time - Temperature alternately flashing.** The kiln is in either a hold phase of a VARY-FIRE segment or a hold phase at the end of an EASY-FIRE Profile. The numbers displayed are the remaining time and the current kiln temperature.

**APPENDIX E**

**EASY-FIRE TEMPERATURE PROFILES**

These charts tell what the EASY-FIRE programs do to your kiln when you choose one of them. These charts will also be good reference points for writing your own programs in the VARY-FIRE mode. These charts are for cones 07 through 04 and cones 5, 6, 7, and 10. Other cone numbers will work as well in your own programs.



**NOTE:** No delays, preheats, or final soaks are shown. When these programs are fired the actual final temperatures will vary as the Dynatrol adjusts itself based on how quickly it is climbing to that final temperature. This would not be the case for VARY-FIRE programs that you develop and input yourself. Also note that all these programs end on segment 7 rather than start on segment 1. This is due to the way the Orton feature works in the EASY-FIRE mode and is not relevant to your own programming in the VARY-FIRE mode. (Segment #7 in the EASY-FIRE mode is a special segment that incorporates the Orton software and so it must be the last segment of every “EASY-FIRE” profile). Start your VARY-FIRE profiles on segment 1.

**CONE 07**

| Slow Bisque Firing Profile for cone |            |                |       |               | 07                               | 1787°F     | Slow Glaze Firing Profile |       |            |  |
|-------------------------------------|------------|----------------|-------|---------------|----------------------------------|------------|---------------------------|-------|------------|--|
| Segment                             | Rate°F /hr | Temperature °F | Hold  | Time in Hours | Segment                          | Rate°F /hr | Temperature °F            | Hold  | Time Hours |  |
| 3                                   | 80         | 250            |       | 2.25          | 5                                | 150        | 250                       |       | 1.20       |  |
| 4                                   | 200        | 1000           |       | 3.75          | 6                                | 400        | 1537                      |       | 3.22       |  |
| 5                                   | 100        | 1100           |       | 1             | 7                                | 120        | 1787                      |       | 2.08       |  |
| 6                                   | 180        | 1537           |       | 2.43          |                                  |            |                           |       |            |  |
| 7                                   | 80         | 1787           | 0     | 3.13          |                                  |            |                           | 0     |            |  |
|                                     |            |                | Total | 12.55         |                                  |            |                           | Total | 6.50       |  |
| <b>Fast Bisque Firing Profile</b>   |            |                |       |               | <b>Fast Glaze Firing Profile</b> |            |                           |       |            |  |
| Segment                             | Rate°F /hr | Temperature °F | Hold  | Time in Hours | Segment                          | Rate°F /hr | Temperature °F            | Hold  | Time Hours |  |
| 3                                   | 120        | 250            |       | 1.50          | 6                                | 570        | 1537                      |       | 2.57       |  |
| 4                                   | 300        | 1000           |       | 2.50          | 7                                | 200        | 1787                      |       | 1.25       |  |
| 5                                   | 150        | 1100           |       | 0.67          |                                  |            |                           |       |            |  |
| 6                                   | 180        | 1537           |       | 2.43          |                                  |            |                           |       |            |  |
| 7                                   | 108        | 1787           | 0     | 2.31          |                                  |            |                           | 0     |            |  |
|                                     |            |                | Total | 9.41          |                                  |            |                           | Total | 3.82       |  |

**NOTE: All the programs shown are written to accommodate the fastest possible empty kilns. THE NUMBERS DO NOT REPRESENT TYPICAL KILN FIRING TIMES WITH A LOAD. Your kiln can take considerably longer (as much as 4 times) to fire than the times shown here.**

## DYNATROL REFERANCE MANUAL (Blue 700- Rev 5.0)

### CONE 06

| Slow Bisque Firing Profile for cone |            |                |       | 06 1819 °F    |                                  | Slow Glaze Firing Profile |                |       |            |
|-------------------------------------|------------|----------------|-------|---------------|----------------------------------|---------------------------|----------------|-------|------------|
| Segment                             | Rate°F /hr | Temperature °F | Hold  | Time in Hours | Segment                          | Rate°F /hr                | Temperature °F | Hold  | Time Hours |
| 3                                   | 80         | 250            |       | 2.25          | 5                                | 150                       | 250            |       | 1.20       |
| 4                                   | 200        | 1000           |       | 3.75          | 6                                | 400                       | 1569           |       | 3.30       |
| 5                                   | 100        | 1100           |       | 1             | 7                                | 120                       | 1819           |       | 2.08       |
| 6                                   | 180        | 1569           |       | 2.61          |                                  |                           |                |       |            |
| 7                                   | 80         | 1819           | 0     | 3.13          |                                  |                           |                | 0     |            |
|                                     |            |                | Total | 12.73         |                                  |                           |                | Total | 6.58       |
| <b>Fast Bisque Firing Profile</b>   |            |                |       |               | <b>Fast Glaze Firing Profile</b> |                           |                |       |            |
| Segment                             | Rate°F /hr | Temperature °F | Hold  | Time in Hours | Segment                          | Rate°F /hr                | Temperature °F | Hold  | Time Hours |
| 3                                   | 120        | 250            |       | 1.50          | 6                                | 570                       | 1569           |       | 2.63       |
| 4                                   | 300        | 1000           |       | 2.50          | 7                                | 200                       | 1819           |       | 1.25       |
| 5                                   | 150        | 1100           |       | 0.67          |                                  |                           |                |       |            |
| 6                                   | 180        | 1569           |       | 2.61          |                                  |                           |                |       |            |
| 7                                   | 108        | 1819           | 0     | 2.31          |                                  |                           |                | 0     |            |
|                                     |            |                | Total | 9.59          |                                  |                           |                | Total | 3.88       |

### CONE 05

| Slow Bisque Firing Profile for cone |            |                |       | 05 1891 °F    |                                  | Slow Glaze Firing Profile |                |       |            |
|-------------------------------------|------------|----------------|-------|---------------|----------------------------------|---------------------------|----------------|-------|------------|
| Segment                             | Rate°F /hr | Temperature °F | Hold  | Time in Hours | Segment                          | Rate°F /hr                | Temperature °F | Hold  | Time Hours |
| 3                                   | 80         | 250            |       | 2.25          | 5                                | 150                       | 250            |       | 1.20       |
| 4                                   | 200        | 1000           |       | 3.75          | 6                                | 400                       | 1641           |       | 3.48       |
| 5                                   | 100        | 1100           |       | 1             | 7                                | 120                       | 1891           |       | 2.08       |
| 6                                   | 180        | 1641           |       | 3.01          |                                  |                           |                |       |            |
| 7                                   | 80         | 1891           | 0     | 3.13          |                                  |                           |                | 0     |            |
|                                     |            |                | Total | 13.13         |                                  |                           |                | Total | 6.76       |
| <b>Fast Bisque Firing Profile</b>   |            |                |       |               | <b>Fast Glaze Firing Profile</b> |                           |                |       |            |
| Segment                             | Rate°F /hr | Temperature °F | Hold  | Time in Hours | Segment                          | Rate°F /hr                | Temperature °F | Hold  | Time Hours |
| 3                                   | 120        | 250            |       | 1.50          | 6                                | 570                       | 1641           |       | 2.75       |
| 4                                   | 300        | 1000           |       | 2.50          | 7                                | 200                       | 1891           |       | 1.25       |
| 5                                   | 150        | 1100           |       | 0.67          |                                  |                           |                |       |            |
| 6                                   | 180        | 1641           |       | 3.01          |                                  |                           |                |       |            |
| 7                                   | 108        | 1891           | 0     | 3.13          |                                  |                           |                | 0     |            |
|                                     |            |                | Total | 10.81         |                                  |                           |                | Total | 4          |

**NOTE: All the programs shown are written to accommodate the fastest possible empty kilns. THE NUMBERS DO NOT REPRESENT TYPICAL KILN FIRING TIMES WITH A LOAD. Your kiln can take considerably longer (as much as 4 times) to fire than the times shown here.**



## DYNATROL REFERANCE MANUAL (Blue 700- Rev 5.0)

### CONE 04

| Slow Bisque Firing Profile for cone |            |                |       | 04            | 1926°F  | Slow Glaze Firing Profile        |                |       |            |
|-------------------------------------|------------|----------------|-------|---------------|---------|----------------------------------|----------------|-------|------------|
| Segment                             | Rate°F /hr | Temperature °F | Hold  | Time in Hours | Segment | Rate°F /hr                       | Temperature °F | Hold  | Time Hours |
| 3                                   | 80         | 250            |       | 2             | 5       | 150                              | 250            |       | 1          |
| 4                                   | 200        | 1000           |       | 4             | 6       | 400                              | 1676           |       | 4          |
| 5                                   | 100        | 1100           |       | 1             | 7       | 120                              | 1926           |       | 2          |
| 6                                   | 180        | 1676           |       | 3             |         |                                  |                |       |            |
| 7                                   | 80         | 1926           | 0     | 3             |         |                                  |                | 0     |            |
|                                     |            |                | Total | 13            |         |                                  |                | Total | 7          |
| <b>Fast Bisque Firing Profile</b>   |            |                |       |               |         | <b>Fast Glaze Firing Profile</b> |                |       |            |
| Segment                             | Rate°F /hr | Temperature °F | Hold  | Time in Hours | Segment | Rate°F /hr                       | Temperature °F | Hold  | Time Hours |
| 3                                   | 120        | 250            |       | 2             | 6       | 570                              | 1676           |       | 3          |
| 4                                   | 300        | 1000           |       | 3             | 7       | 200                              | 1926           |       | 1          |
| 5                                   | 150        | 1100           |       | 1             |         |                                  |                |       |            |
| 6                                   | 180        | 1676           |       | 3             |         |                                  |                |       |            |
| 7                                   | 108        | 1926           | 0     | 2             |         |                                  |                | 0     |            |
|                                     |            |                | Total | 11            |         |                                  |                | Total | 4          |

### CONE 5

| Slow Bisque Firing Profile for cone |            |                |       | 5             | 2165°F  | Slow Glaze Firing Profile        |                |       |            |
|-------------------------------------|------------|----------------|-------|---------------|---------|----------------------------------|----------------|-------|------------|
| Segment                             | Rate°F /hr | Temperature °F | Hold  | Time in Hours | Segment | Rate°F /hr                       | Temperature °F | Hold  | Time Hours |
| 3                                   | 80         | 250            |       | 2.25          | 5       | 150                              | 250            |       | 1.20       |
| 4                                   | 200        | 1000           |       | 3.75          | 6       | 400                              | 1915           |       | 4.16       |
| 5                                   | 100        | 1100           |       | 1             | 7       | 120                              | 2165           |       | 2.08       |
| 6                                   | 180        | 1915           |       | 4.43          |         |                                  |                |       |            |
| 7                                   | 80         | 2165           | 0     | 3.13          |         |                                  |                | 0     |            |
|                                     |            |                | Total | 14.66         |         |                                  |                | Total | 7.44       |
| <b>Fast Bisque Firing Profile</b>   |            |                |       |               |         | <b>Fast Glaze Firing Profile</b> |                |       |            |
| Segment                             | Rate°F /hr | Temperature °F | Hold  | Time in Hours | Segment | Rate°F /hr                       | Temperature °F | Hold  | Time Hours |
| 3                                   | 120        | 250            |       | 1.50          | 6       | 570                              | 1915           |       | 3.24       |
| 4                                   | 300        | 1000           |       | 2.50          | 7       | 200                              | 2165           |       | 1.25       |
| 5                                   | 150        | 1100           |       | 0.67          |         |                                  |                |       |            |
| 6                                   | 180        | 1915           |       | 4.53          |         |                                  |                |       |            |
| 7                                   | 108        | 2165           | 0     | 2.31          |         |                                  |                | 0     |            |
|                                     |            |                | Total | 11.51         |         |                                  |                | Total | 4.49       |

**NOTE: All the programs shown are written to accommodate the fastest possible empty kilns. THE NUMBERS DO NOT REPRESENT TYPICAL KILN FIRING TIMES WITH A LOAD. Your kiln can take considerably longer (as much as 4 times) to fire than the times shown here.**

## DYNATROL REFERANCE MANUAL (Blue 700- Rev 5.0)

### CONE 6

| Slow Bisque Firing Profile for cone |             |                |       | 6 2199 °F                        |         | Slow Glaze Firing Profile |                |       |            |
|-------------------------------------|-------------|----------------|-------|----------------------------------|---------|---------------------------|----------------|-------|------------|
| Segment                             | Rate °F /hr | Temperature °F | Hold  | Time in Hours                    | Segment | Rate °F /hr               | Temperature °F | Hold  | Time Hours |
| 3                                   | 80          | 250            |       | 2.25                             | 5       | 150                       | 250            |       | 1.20       |
| 4                                   | 200         | 1000           |       | 3.75                             | 6       | 400                       | 1949           |       | 4.25       |
| 5                                   | 100         | 1100           |       | 1                                | 7       | 120                       | 2199           |       | 2.08       |
| 6                                   | 180         | 1949           |       | 4.72                             |         |                           |                |       |            |
| 7                                   | 80          | 2199           | 0     | 3.13                             |         |                           |                | 0     |            |
|                                     |             |                | Total | 14.85                            |         |                           |                | Total | 7.53       |
| <b>Fast Bisque Firing Profile</b>   |             |                |       | <b>Fast Glaze Firing Profile</b> |         |                           |                |       |            |
| Segment                             | Rate °F /hr | Temperature °F | Hold  | Time in Hours                    | Segment | Rate °F /hr               | Temperature °F | Hold  | Time Hours |
| 3                                   | 120         | 250            |       | 1.50                             | 6       | 570                       | 1949           |       | 3.30       |
| 4                                   | 300         | 1000           |       | 2.50                             | 7       | 200                       | 2199           |       | 1.25       |
| 5                                   | 150         | 1100           |       | 0.67                             |         |                           |                |       |            |
| 6                                   | 180         | 1949           |       | 4.72                             |         |                           |                |       |            |
| 7                                   | 108         | 2199           | 0     | 2.31                             |         |                           |                | 0     |            |
|                                     |             |                | Total | 11.70                            |         |                           |                | Total | 4.55       |

### CONE 7

| Slow Bisque Firing Profile for cone |             |                |       | 7 2228 °F                        |         | Slow Glaze Firing Profile |                |       |            |
|-------------------------------------|-------------|----------------|-------|----------------------------------|---------|---------------------------|----------------|-------|------------|
| Segment                             | Rate °F /hr | Temperature °F | Hold  | Time in Hours                    | Segment | Rate °F /hr               | Temperature °F | Hold  | Time Hours |
| 3                                   | 80          | 250            |       | 2.25                             | 5       | 150                       | 250            |       | 1.20       |
| 4                                   | 200         | 1000           |       | 3.75                             | 6       | 400                       | 1978           |       | 4.32       |
| 5                                   | 100         | 1100           |       | 1                                | 7       | 120                       | 2228           |       | 2.08       |
| 6                                   | 180         | 1978           |       | 4.88                             |         |                           |                |       |            |
| 7                                   | 80          | 2228           | 0     | 3.13                             |         |                           |                | 0     |            |
|                                     |             |                | Total | 15                               |         |                           |                | Total | 7.60       |
| <b>Fast Bisque Firing Profile</b>   |             |                |       | <b>Fast Glaze Firing Profile</b> |         |                           |                |       |            |
| Segment                             | Rate °F /hr | Temperature °F | Hold  | Time in Hours                    | Segment | Rate °F /hr               | Temperature °F | Hold  | Time Hours |
| 3                                   | 120         | 250            |       | 1.50                             | 6       | 570                       | 1978           |       | 3.35       |
| 4                                   | 300         | 1000           |       | 2.50                             | 7       | 200                       | 2228           |       | 1.25       |
| 5                                   | 150         | 1100           |       | 0.67                             |         |                           |                |       |            |
| 6                                   | 180         | 1978           |       | 4.88                             |         |                           |                |       |            |
| 7                                   | 108         | 2228           | 0     | 2.31                             |         |                           |                | 0     |            |
|                                     |             |                | Total | 11.86                            |         |                           |                | Total | 4.60       |

**NOTE: All the programs shown are written to accommodate the fastest possible empty kilns. THE NUMBERS DO NOT REPRESENT TYPICAL KILN FIRING TIMES WITH A LOAD. Your kiln can take considerably longer (as much as 4 times) to fire than the times shown here.**

## DYNATROL REFERANCE MANUAL (Blue 700- Rev 5.0)

### CONE 10

| Slow Bisque Firing Profile for cone |             |                |       | 10 2345 °F    |                                  | Slow Glaze Firing Profile |                |       |            |
|-------------------------------------|-------------|----------------|-------|---------------|----------------------------------|---------------------------|----------------|-------|------------|
| Segment                             | Rate °F /hr | Temperature °F | Hold  | Time in Hours | Segment                          | Rate °F /hr               | Temperature °F | Hold  | Time Hours |
| 3                                   | 80          | 250            |       | 2             | 5                                | 150                       | 250            |       | 1          |
| 4                                   | 200         | 1000           |       | 4             | 6                                | 400                       | 2095           |       | 5          |
| 5                                   | 100         | 1100           |       | 1             | 7                                | 120                       | 2345           |       | 2          |
| 6                                   | 180         | 2095           |       | 6             |                                  |                           |                |       |            |
| 7                                   | 80          | 2345           | 0     | 3             |                                  |                           |                | 0     |            |
|                                     |             |                | Total | 16            |                                  |                           |                | Total | 8          |
| <b>Fast Bisque Firing Profile</b>   |             |                |       |               | <b>Fast Glaze Firing Profile</b> |                           |                |       |            |
| Segment                             | Rate °F /hr | Temperature °F | Hold  | Time in Hours | Segment                          | Rate °F /hr               | Temperature °F | Hold  | Time Hours |
| 3                                   | 120         | 250            |       | 2             | 6                                | 570                       | 2095           |       | 4          |
| 4                                   | 300         | 1000           |       | 3             | 7                                | 200                       | 2345           |       | 1          |
| 5                                   | 150         | 1100           |       | 1             |                                  |                           |                |       |            |
| 6                                   | 180         | 2095           |       | 6             |                                  |                           |                |       |            |
| 7                                   | 108         | 2345           | 0     | 2             |                                  |                           |                | 0     |            |
|                                     |             |                | Total | 13            |                                  |                           |                | Total | 5          |

**NOTE: All the programs shown are written to accommodate the fastest possible empty kilns. THE NUMBERS DO NOT REPRESENT TYPICAL KILN FIRING TIMES WITH A LOAD. Your kiln can take considerably longer (as much as 4 times) to fire than the times shown here.**

**APPENDIX G**

**ERROR CODES**

| <b>Error Code</b>   | <b>Description</b>   | <b>Quick View</b><br>NOTE: ">" means greater than, "<" means less than           |
|---------------------|--|--|
| <b>E 0<br/>RPCN</b> | Software Error. Recheck the selected program, and reprogram if necessary. You may have to contact the L&L for new software.  |  |
| <b>E 1</b>          | The temperature is increasing less than 12 degrees per hour during a ramp segment, where the temperature is programmed to increase. This slow rate must persist for 22.5 minutes before the error is displayed. This can be caused by low power to the kiln, aged elements, etc. See the kiln Troubleshooting Guide to check for all the things that could cause slow heat up. It is one of the most common error codes. Try running the kiln with the error codes turned off. Note that Err1 is only a possibility during a ramp. | Ramp segment<br>Temp. increase < 12°F/hr<br>Persists > 22.5 min.                 |
| <b>E 2</b>          | During a hold segment the temperature rises to greater than 50 degrees above the hold temperature which was set. The temperature must stay 50 degrees above this set temperature for 18 seconds before the error is displayed.   | Hold segment<br>50°F above set temp.<br>Persists > 18 sec.                       |
| <b>E 3</b>          | During a hold segment the temperature is more than 50 degrees below the hold temperature which was set. The temperature must stay 50 degrees below this set temperature for 18 seconds before the error is displayed.  | Hold segment<br>50°F below set temp.<br>Persists > 18 sec.                       |
| <b>E 4</b>          | The temperature is more than 50 degrees above the previous hold temperature during a ramp segment where the temperature is programmed to decrease. The temperature must stay 50 degrees above this set temperature for 18 seconds before the error is displayed.   | Decreasing Ramp segment<br>50°F above last hold temp.<br>Persists > 18 sec.      |
| <b>E 5</b>          | The temperature is more than 50 degrees below the local setpoint temperature during a ramp segment where the temperature is programmed to decrease. The temperature must stay 50 degrees below this set temperature for 18 seconds before the error is displayed.  | Decreasing Ramp segment<br>50°F below local setpoint temp.<br>Persists > 18 sec. |
| <b>E 6</b>          | A Negative temperature is displayed. This generally indicates the thermocouple is connected incorrectly. To correct this situation, ensure the red and yellow wires are connected correctly to the controller and at all junctions. You can identify the red lead on an unmarked thermocouple with a magnet because a magnet will be attracted to the red lead.  | (-) displayed  |
| <b>E 7</b>          | The temperature is more than 50 degrees above the local setpoint temperature during a ramp segment where the temperature is programmed to increase. The temperature must stay 50 degrees above this set temperature for 18 seconds before the error is displayed.  | Increasing Ramp segment<br>50°F above local setpoint temp.<br>Persists > 18 sec. |
| <b>E 8</b>          | When using the EASY-FIRE Mode, the temperature is decreasing during the last ramp segment. This could indicate that (if provided on your kiln) that a kiln sitter has turned the kiln off or that the lid was up or the peepholes open or some other physical thing is causing the kiln to decrease in temperature.  | Cone fire mode only<br>Temp. decreasing during last ramp segment                 |
| <b>E 9</b>          | There is amismatch between the thermocouple type selected in the software and the jumper for the thermocouple type. See section 4.4.12 to correct. (Also see section 1.0 about thermocouple extension wire).   |  |

## DYNATROL REFERANCE MANUAL (Blue 700- Rev 5.0)

|             |   |                |
|-------------|---|----------------|
| <b>PF</b>   | Continuous <b>PF</b> in display. Indicates a long term power outage. The kiln has been shut down. Press <b>1</b> to clear the display.  |                |
| <b>ERRP</b> | <b>ErrP</b> and the current temperature are alternately flashing. To clear the display, press the <b>1</b> key. If a firing was in progress, the kiln will continue to fire even though this message is flashing. This error can also happen as a result of RF noise that resets the microprocessor. If this is suspected, the control panel should be returned to L&L for testing and possible modification.   |                |
| <b>E d</b>  | This is “Error Difference.” <b>Errd</b> indicates that a difference of more than a 100 degrees has been detected between any of the thermocouples and the set point. When <b>Errd</b> is displayed the firing will be terminated. <b>Errd</b> will not be detected if the error codes ( <b>ErCd</b> ) have been turned off. The reason for having <b>Errd</b> is to insure against a case where, for instance, the top ( <b>tC1</b> ) and bottom ( <b>tC3</b> ) thermocouples have been inadvertently switched. In such a case the top thermocouple ( <b>tC1</b> ), while placed in the bottom section, could be calling for heat and the heat will be delivered to the bottom of the kiln causing a grossly uneven firing. The first thing to test, if you have this error code, is that the thermocouples are placed in the proper sections. To do this take each thermocouple out (while the kiln is cold) and heat it with a match while pressing the 1, 2, or 3 button on the control to read the appropriate thermocouple. Top should be #1, Middle should be #2 and Bottom should be #3. Another potential cause of this error code could be the sections stacked in the wrong order, or plugged into the control’s receptacles in the wrong order. If not this, a bad element in one of the sections. Check to see if the elements are firing. Check resistance on the elements (see the troubleshooting guide or the general kiln instructions or contact L&L for information on this). Another possibility is a bad contactor or bad receptacle or loose wire. Using a digital multi-meter that allows you to test voltage in an outlet and resistance in a circuit (available from any good electronics or hardware store) you, your electrician, or your local kiln distributor can see whether a circuit is actually delivering power to the receptacles on the control box, and exactly what the resistance of your elements are. |                |
| <b>E E</b>  | A hardware error has been detected by the controller software. The controller must be returned for service.   | Hardware error |

## **APPENDIX G**

### **HOW THREE ZONE CONTROL IS USED ON A TWO, FOUR AND FIVE SECTION KILN AND WITH A POWERED BOTTOM**

On kilns with four heating sections the center two heating sections are tied together as one center zone. On kilns with five heating sections the center three heating sections are tied together as one center zone. Each section still has its own separate contactor, but the center zone control output controls one contactor on a three section kiln, two contactors on a four section kiln and three contactors on a five section kiln. We suggest placing the center zone thermocouple (**TC2**) in either of the two middle sections on a four section kiln and in the center section on a five section kiln. You can of course experiment to achieve optimal results.

Kilns with two zones typically use inputs (thermocouples) and outputs (receptacles) 1 and 2 even though we usually have a third unused circuit on the control. If you add a section you may want to enable the three zone control (see the section on programming) and possibly add a thermocouple. On kilns with powered bottoms the powered bottom is controlled off the bottom zone control output. This would be the case of a kiln with three or more sections. In the case of a two section kiln with a powered bottom the powered bottom is controlled off the center zone control (**TC2**). This acts as a two zone kiln.

## **APPENDIX H**

### **FREQUENTLY ASKED QUESTIONS**

#### **H.1 During programming of a firing, I typed a wrong number. How do I correct this?**

Before pressing **ENTER**, enter zero until all zeros are displayed, then enter the correct number. If you have already pressed **ENTER**, you must continue to enter the rest of the program as you would have, then you must start over again to program properly, fixing your mistake this time around..

#### **H.2 How do I clear the ERRP/ PF from the display?**

Press the "1" key. After several seconds the current temperature will be displayed. The amount of time the last firing took or **STOP** may be displayed before the current temperature. If the **ERRP/ PF** message is flashing with the alternate display being the temperature then it means that the kiln is still firing after a brief power interruption.

#### **H.3 I am getting the E d message. What is wrong?**

More than likely the kiln was set up improperly. NOTE: It is absolutely necessary to match the proper ring with the proper control box outlet and proper thermocouple. If these are mismatched the kiln will not operate properly and you will get the **E d** display showing that one of the zones is way off set point. Thermocouples, cords and receptacles are all marked for identification. The top zone ring, outlet and thermocouple are all marked #1. In three ring kilns the middle zone is #2 and the bottom is #3. In four ring kilns the middle zone is #2 and #3; the bottom is #4. In five ring kilns the middle is #2, #3 and #4 and the bottom is #5. You can easily test to make sure the thermocouples are properly located by putting a match to one at a time and checking the temperature rise on the control for that thermocouple.

#### **H.4 I am getting the E 1 message. What is wrong?**

This is the most common error message. It means the kiln is rising in temperature too slowly and can be caused by a variety of things. In older kilns it is probably a result of elements being aged or one or more elements not firing for some reason. The first thing to check is element resistance and continuity. See our troubleshooting guide for details. If this happens in a newer kiln it is still a good

## DYNATROL REFERANCE MANUAL (Blue 700- Rev 5.0)

idea to check the elements. One problem we have found is that the thermocouple lead wire was pinched and was creating a short circuit (meaning that the controls was reading whatever temperature was at the pinched point and so, as far as the control was concerned, the kiln wasn't heating up. The way to test for such a condition is first of all to observe that the control is showing a temperature that is greatly different than what you can tell is in the kiln. The other better way is to disconnect the thermocouple and see if the display says **FAIL**. If it does then it means there is no short circuit in the thermocouple circuit. This could also happen with a burned thermocouple connection wire (say if the yellow wire touched the kiln case and the wire insulation burned off). Note that Err1 is only a possibility during a ramp. A common problem is that one of the sections is lagging. Try to find out which section is lagging. If it is the bottom (fairly typical) you could try a 2" layer of calcium silicate under the kiln bottom (this is very inexpensive insulation that is quite hard and non-compressible) or even another brick bottom. If you are using a vent try turning it off towards the high end of the firing cycle. (NOTE: This is OK to do on an L&L Vent-Torr but with some bottom mounted vents you are not supposed to do this or you will burn up the motor). Make sure your peepholes are closed at high fire.. Make sure kiln is loaded evenly, more in the bottom of the kiln than the top will make it fire very slowly also. One last thing to consider is the voltage available to the kiln when it is on and running. Get an electrician to check this at the kiln and be sure it comes pretty close to the kiln's label. Low voltage can cause slow heat ups and voltage lower than 208VAC can also cause problems with the microprocessor in the Dynatrol as well.

### **H.5 My kiln takes longer to fire than I think it should.**

See suggestions above in **E 1** troubleshooting.

### **H.6 My program takes longer to complete than I expected. What is happening?**

The controller actually accomplishes the temperature rise by establishing what's called a traveling set point. The traveling set point is set by the controller at the initial kiln temperature, and it is increased (or decreased) at a rate equal to the ramp rate you have chosen. Anytime the kiln temperature is below this traveling set point the heating elements of the kiln are turned on. If the temperature is above the traveling set point the heating elements are turned off. When both the traveling set point and the average of the measured temperatures reach the first soak temperature, the hold phase begins or the next ramp rate begins. (That is called a guaranteed soak). It means that a program might take longer than the theoretical time you have programmed into it.

### **H.7 My kiln seems to be much hotter than the thermocouples indicate. Or the kiln seems to be going to slow (by the readings on the controller).**

This could be serious. Check to see that the thermocouples are inserted at least 1 to 1-1/2" into the kiln. If the tips of the thermocouples are buried in the kiln wall insulation they will obviously read at a lower temperature than the inside of the kiln. **THIS COULD LEAD TO AN OVERFIRING OF THE KILN!** Another possibility is that there is a short circuit in the thermocouple lead wire. See the above **Err1** question to check the thermocouple circuit.

### **H.8 Is there a guaranteed soak?**

Yes. This means that if the kiln does not reach temperature in the time you assign in a ramp it will not start the hold portion of that segment until the kiln reaches the set point temperature. This also means that the actual time to fire may take longer than you have programmed into the kiln (if it takes longer to get to a particular temperature than you think it ought to take).

### **H.9 I turned on the controller and FAIL is displayed. What does this mean?**

One or more of the thermocouples are not connected to the controller. When connecting the thermocouple, connect the negative wire (on Type K in non-European kilns this is RED) to the connector with the negative (minus) sign under it. Connect the positive wire (on Type K non-European kilns this is YELLOW) to the connector with the positive (plus) sign under it. (See Section 1.0 for information on Type S and European kilns). Also there may be a break in one of the thermocouple lead wires, if so, the thermocouple lead wire must be replaced. Make sure all

## **DYNATROL REFERANCE MANUAL (Blue 700- Rev 5.0)**

thermocouple connections are very secure and tight and that there is a direct touching of the thermocouple lead wire with the actual wire inside the thermocouple. (See I.21)

### **H.10 I keep burning out thermocouples. What is wrong?**

Thermocouples, like elements are a consumable item. They will burn out over time. If you are firing to high temperatures (Cone 5 and above) you should consider either an 8 gauge thermocouple with a ceramic protection tube or Type S thermocouples. A reduction atmosphere (the lack of enough oxygen in the kiln to thoroughly burn off all impurities) attacks elements and thermocouples. Speedy firings especially as the kiln climbs to 1100°F, will not give enough time to burn out these impurities. This is made worse if there is no ventilation to the kiln. An open peephole or three may be enough, or a downdraft venting system like L&L's Vent Sure system may be what you need for a good, clean, oxidizing atmosphere.

### **H.11 How can I find out the final temperature which was reached during a cone firing?**

At the end of an EASY-FIRE firing, the current kiln temperature and **CPLT** will be alternately flashing in the display. Press **ENTER** or **START/STOP**. Then press **Review Program**, the final temperature will display. This final temperature will be retained until the next firing or until the controller is reprogrammed. In a VARY-FIRE program the Dynatrol will fire to the temperature programmed.

### **H.12 My kiln underfires, turns off before the DynaTrol reaches its set point .**

If you have a Dawson Kiln Sitter as a back up safety device be sure that the cone in it is at least two to three cones higher than your final set point temperature. Remember that, when using the DynaTrol control, the optional kiln sitter is only safety back up controls. You do not want it to actually actuate. If you have a Dawson Kiln Sitter/Timer, be sure the time is set higher than the expected length of your program. See above answer about the kiln sitter safety control. Also you may need to calibrate; to adjust the cone settings with the cone offset. Note that it is common for thermocouples to "drift" in their readings. As this happens the cone offset or the thermocouple offset can compensate for this. Sometimes fire with witness cones so you can compare what the control did to the actual performance of cones.

### **H.13 Why use a soak time or make the kiln go slow?**

Most ceramics achieves its characteristics not so much by what temperature it reaches but by how much "heat-work" is put into it. A long soak at a lower cone can often develop the bisque or glaze better. In addition a soak period almost always will improve the uniformity of the firing throughout the kiln. A soak period gives the entire load of ware time to absorb the radiant heat that is projected from the elements. If you simply rise to a certain temperature and then shut the kiln off (as is typical of a manual kiln sitter operation) then the center of the kiln may not have had a chance to absorb as much heat as the ware around the perimeter. The same would be true for a thick piece of pottery if it was just heated to a temperature and then cooled. The middle of the piece would never get to the same temperature as the outside of the piece, and in extreme situations, if it was heated very quickly, could cause the piece to explode. You may have experienced the fact that an older kiln, with slow firing elements may in fact have given you better results. This is because the entire kiln has had a chance to even itself out as it approached final cone. A slow heat up will result in "cleaner" bisque. It will give the kiln time to burn out impurities like sulfur and carbon out of the clay. These impurities can cause pitting and other problems when you subsequently glaze the ware if they have not been given sufficient time to burn off during the bisque.

### **H.14 Can you change a program segment while running a program?**

No. You must first Stop the program by hitting **START/STOP**. Then change the program. Then re-start the program. The control will automatically start from where you were previously. For instance if the kiln temperature is at 1200°F and this is segment No 2 it will restart from that point



## DYNATROL REFERANCE MANUAL (Blue 700- Rev 5.0)

in the program. You can advance to the next segment (in a VARY-FIRE Program). See the directions in under Skip Step in the View Section.

### **H.15 When the control flashes TC2 alternating with a temperature does it read that until you toggle to a different thermocouple?**

The control is continually reading the temperatures in all three zones. However it only displays one temperature at a time. It does not scroll automatically. To manually scroll to the different thermocouples hit either 1, 2 or 3. The default display is thermocouple #2.

### **H.16 Is there a lead zone?**

No. Each zone is controlled independently with a separate input (each thermocouple), and a separate output (the signal from the Dynatrol to one of the contactors to send or not to send power to the elements. The output of the zones can be quite different. For instance the top zone (#1) may be calling for 75% output while the middle zone (#2) is calling for 35% output while the bottom zone (#3) is calling for 90% output. This percentage is the percent of time that a zone is on, out of the total time elapsed. This is a time proportioning control.

### **H.17 Is this a time proportioning control?**

Yes. The control determines what the percent of output (0-100%) is required to properly heat the kiln. It then converts this into amount of time on and time off that the contactor should be firing. This is different than current proportioning which would send a proportional current to adjust an continually adjustable SCR power control for instance.

### **H.18 What happens when I turn off the Error Codes?**

It is O.K. to do this. However, you will not get certain operator protections which might prevent you from getting a poorly fired kiln. They can be turned off if you are doing special firings, such as jewelry or glass firing where the kiln is left open. This will also turn off the Dynamic Zone Control, and the **E d** function when the Error Codes are turned off. This turns off most error functions so that kiln is not affected by these built in checks. It eliminates nuisance shut downs but side steps built in "fool proofing". The only Error codes that this does not turn off are **E 6**, **FAIL**, and **ErrP/ PF** in both the EASY-FIRE and VARY-FIRE modes. In addition **E 1** (indicating slow temperature rise) and **E 8** (temperature falling) is not turned off in the last segment of an "EASY-FIRE" program. This is because the built in calculations would make no sense if the kiln were firing too slowly.

### **H.19 What happens when a thermocouple fails?**

If the top (**TC1**) thermocouple fails then the top (**TC1**) and middle (**TC2**) work together from the **TC2** thermocouple. If the bottom (**TC3**) fails then the bottom (**TC3**) and middle (**TC2**) work together from the **TC2** thermocouple. If the middle (**TC2**) fails then the top (**TC1**) and middle (**TC2**) work together from the **TC1** thermocouple.

### **I.20 One or more of the thermocouples reads FAIL. What is wrong?**

One or more of the thermocouple circuits has failed. Chances are this is a bad thermocouple. Even if the thermocouple looks OK there might be a microscopic crack that could fail intermittently. A simple test to see if the problem is in the thermocouple itself or in the thermocouple wire is to do the following: Disconnect the thermocouple from the yellow lead/extension wire that attaches at the cold end of the thermocouple. Touch together the red and yellow leads coming out of the yellow lead/extension wire (note: this is very low milli-voltage and is not dangerous). This will complete the thermocouple circuit and eliminate the actual thermocouple from consideration. Now press the #1 button, If the **FAIL** message goes away then you know it is a bad thermocouple. If the **FAIL** message does not go away then the next thing to check is make sure that the thermocouple is properly attached to the connection board on the control. If this looks OK then the yellow extension wire should be replaced or the Dynatrol might have a problem. (See I.9)

## **H.21 What is PID and can the PID settings be changed?**

PID stands for “Proportional, Integral, Derivative” This is a mathematical calculus function built into the control that proportions the amount of power going to the output device (contactor) as the kiln approaches set point temperature. It is used to prevent overshoot which you would get if the control did not turn off until it reached the set point. The values are fixed and based on average kiln conditions. Because most kiln conditions are fairly similar and the ramps are very slow by most industrial standards not much flexibility needs to be built into the PID constants. There is no “adaptive tuning.” The values for the PID are hard programmed into the control and can not be changed. They are optimized for ceramics. If you are using the control for another application and you find that the control gives you some overshoot try a step in your program that is a very slow ramp for the last few degrees of the program. For instance if you wanted to get to 1800°F without overshoot have the program go to 1775°F and then take 15 minutes to ramp to 1800°F .

NOTE: Do not confuse the PID talked about here with the “PID” setting in the Hidden Other Menu.

## **H.22 Is there any way to know what the set point actually is?**

Yes. Press Review Segment twice while the kiln is firing and the set point will appear.

## **H.23 What happens if there is a power outage?**

If the power outage lasts for less than ½ hour the control should pick up where it left off unless the kiln temperature has dropped more than 250°F or, if it is within 100°F of the end of the firing then only a 100°F drop off is allowed. If the program automatically aborts based on the above logic then it must be manually restarted. If you restart the program, the control will find out where the temperature is and will start from there. If you get a power outage you will see an **ErrP** or **PF** error code. This must be reset by hitting any button on the key pad.

## **H.24 The display is jumpy. What about Thermocouple noise?**

The negative lead of the thermocouples are automatically grounded to the safety ground. This typically is able to remove thermocouple noise from the system. Thermocouple noise is typically caused by stray electrical currents induced into the low voltage thermocouple circuits by the kiln elements. It shows up as “jumpy” temperature readings on the control. A little of this is OK but if the readings are very jumpy it can confuse the control. If you see this sort of “jumpiness” check all ground connections involved for tightness and continuity. If the ground is OK and the thermocouples are in the factory provided holes, in your kiln about one and one half inches, then contact L&L or a certified repairman for assistance. NOTE: thermocouples in homemade holes that may be positioned too close to the elements, could receive more of the inductive current generated by the elements, therefore receive more noise (NOTE: In extreme cases L&L can retrofit your control box with a noise suppresser and even wire the box so that the control voltage is feed through a separate 120 volt cord).

## **H.25 Do thermocouples need to be grounded or ungrounded?**

They must be ungrounded thermocouples. Grounded thermocouples will cause problems with this control. The negative leads of the thermocouples are connected to the kiln ground. (See above). Be sure there is only one ground to your kiln. This is normally through the plug or main power connection all the way to the “earth ground”. The control is grounded and RF noise generated in the thermocouples (from the elements and other sources) is drawn into the sheath ground and into the negative lead of the thermocouple and then ultimately out to earth ground.

## **H.26 Can I override the end of a firing to gain temperature?**

Lets say you just fired a load and you can see through your peephole (looking at a witness cone) that your load did not fire to full maturity. Restart the program with a higher cone value and then manually shut off kiln when the witness cone starts to mature. Use the cone offset feature next time to eliminate this problem before it happens again.

## **DYNATROL REFERANCE MANUAL (Blue 700- Rev 5.0)**

### **H.27 I hear the contactors clicking on and off when the kiln is at a low temperature and even though my set point is way above the temperature readings. Why?**

The control only allows power for about 1/3 of the time when the kiln temperature is below 500°F. This is because kilns are generally overpowered for these low temperatures and the control would constantly be overshooting any lower temperature set points without this feature.

### **H.28 What does it mean when the display flashes?**

The Dynatrol is trying to give more information than can fit on just one displayed message. Either the message cycles over and over again, like **IdLE**, **TC2**, current temperature, or the messages continue to flash by quickly, as in the case of what happens when you press the Review Program button.

### **H.29 What does CPL mean?**

“CPL” means that programming an option or a sequence of steps has been completed.

### **H.30 How do you turn off the audible alarm?**

The alarm is an audible signal. You can turn it off (after it turns on) by pressing **ENTER**. Set it for **9999** to disable it.

### **H.31 How do I get information about my firing?**

When the program has completed it will flash **CPLT** and the time it took to get to temperature. After pressing **STOP** you can press **REVIEW PROGRAM** to get more information about the firing. The display will scroll through the following: the Cone you set it at, the actual temperature that the kiln achieved, what speed you had it set for, and hold time etc. This only works in the EASY-FIRE mode. In the VARY-FIRE mode, if you press **REVIEW PROGRAM** you see what you programmed only. This information will be retained in memory until the control is reprogrammed.

### **H.32 What ambient temperature conditions do I need for the control?**

Do not operate the controller in temperatures above 125°F or below 0°F or 0°C. Actually a little hotter or colder will still be within tolerance of the components. The real component rating is near 160°F. If you are using the Celsius temperature scale 0°C is the lowest operating temperature possible as the Dynatrol thinks a negative temperature displayed is because of a thermocouple installed backwards, not because it could be cold outside. and . (NOTE: The board components are rated for 50°C below zero so the control (and kiln) can be stored outside in a covered area).

### **H.33 The kiln did not begin soaking when it should have.**

The fact that the kiln did not start to soak when it seems like it should could be due to the fact that an average of all the process variables (TC readings) and the traveling set point have to reach set point temperature before the hold begins. Or the dynatrol has computed a higher temp (than you expected it to) to equate to the cone # fired to and the rate of climb... Once it gets to where it determines the cone is , it will begin the hold.

### **H. 34 The thermocouples seem to be off according to the cones.**

If you had an **ErrP** or **PF** message while firing, and the kiln temperature went down briefly, the cones may have misrepresented actual temperature for the following reason: If the temperature decreases in the kiln temporarily after the cone begins to form a glass (starts to mature even though it may not be visible) the decrease in temperature could "freeze" the cone and prevent it from operating properly. Cone temperatures also vary according to how quickly the kiln climbs in temperature. Thermocouples do age, sometimes rapidly, and may not read like they used to. Try a cone offset to raise or lower the entire kiln's final temperature for the cone you have programmed. Or try a thermocouple offset if it is just one or two zones that are consistently hotter or cooler than they should be.

## DYNATROL REFERANCE MANUAL (Blue 700- Rev 5.0)

### H.35 How do I ramp down?

You must use the VARY-FIRE Mode. The control will change the path of the firing profile in the direction of the next segment's set point. In other words if the current segment has a set point of 500°F and the following segment has a set point of 1000°F then the control will ramp the set point in the "up" direction. Conversely if the current segment has a set point of 1000°F and the next segment has a setpoint of 500°F then the control will ramp the set point in the "down" direction. See the specific instructions in the Programming section under VARY-FIRE.

### H.36 Does the control work on 50 HZ?

Yes. The control will work on either 50 Hz or 60 Hz. The electrical cycle does not affect any timing circuits in the control.

### H.37 TEMPERATURE READINGS VS CONES

Automatic controls are great tools. *They are not complete tools, however.* They base what they do on electrical signals generated by the thermocouples that get interpreted by the electronic control as specific temperatures. There are four inherent problems with this. First, the thermocouples are only measuring temperature at the very tip of the thermocouple. Typically this is placed an inch or two in from the inside surface of the kiln. The thermocouple is usually not measuring the temperature in the middle of the kiln. Second, there is an inherent error in the thermocouple of a few degrees either way. Third, thermocouples drift in their accuracy over time. Fourth, and perhaps most important, thermocouples only measure temperature. For ceramics you are really interested in "heat-work" or the amount of heat that is absorbed by your ware over time. It is like baking a cake. Absolute temperature is only one factor in the successful baking. For all these reasons we highly recommend the use of witness cones in every firing. These will tell you what really happened in the kiln. We suggest using a set of three witness cones in each zone for the kiln. At the absolute minimum use one witness cone per firing to check basic performance of the kiln and control. Then using this accurate information you can use the many features of the DynaTrol to conform the performance of the control to your exact needs. You may want to try firing the kiln with all the preset programs with witness cones to see just how the type of program affects the cones you will be using. Keep good records and get to know your kiln, the Dynatrol and how the combination of these two things with the kind of ware that you fire all work together. **There is no substitute for experimentation and personal individualized documentation.**

**APPENDIX I**

**VARY-FIRE DEFAULT PROGRAM'S TEMPERATURE PROFILES**

| USER 1: Medium Speed Glass Slumping ProfileSegment | Rate | degF | Hold  |
|--|------|------|-------|
| 1  | 500  | 250  | 00:12 |
| 2  | 500  | 500  | 00:12 |
| 3  | 500  | 750  | 00:12 |
| 4  | 600  | 1100 | 00:05 |
| 5  | 600  | 1220 | 00:05 |
| 6  | 9999 | 1000 | 01:00 |
| 7  | 90   | 970  | 01:00 |
| 8  | 120  | 750  | 00:01 |

USER 2: Medium Speed Glass Tack Fuse Profile

| Segment | Rate | degF | Hold  |
|---------|------|------|-------|
| 1       | 500  | 250  | 00:12 |
| 2       | 500  | 500  | 00:12 |
| 3       | 500  | 750  | 00:12 |
| 4       | 600  | 1250 | 00:20 |
| 5       | 600  | 1350 | 00:10 |
| 6       | 9999 | 1000 | 01:00 |
| 7       | 90   | 970  | 01:00 |
| 8       | 120  | 750  | 00:01 |

USER 3: Medium Speed Full Fuse Profile

| Segment | Rate | degF | Hold  |
|---------|------|------|-------|
| 1       | 500  | 250  | 00:12 |
| 2       | 500  | 500  | 00:12 |
| 3       | 500  | 750  | 00:12 |
| 4       | 600  | 1250 | 00:20 |
| 5       | 600  | 1480 | 00:15 |

## DYNATROL REFERANCE MANUAL (Blue 700- Rev 5.0)

|   |      |      |       |
|---|------|------|-------|
| 6 | 9999 | 1000 | 01:00 |
| 7 | 90   | 970  | 01:00 |
| 8 | 120  | 750  | 00:01 |

### USER 4: Glass Bead Annealing Profile

| Segment | Rate | degF | Hold  |
|---------|------|------|-------|
| 1       | 9999 | 960  | 08:00 |
| 2       | 9999 | 960  | 00:40 |

### USER 5: Lost Wax Burnout Profile

| Segment | Rate | degF | Hold  |
|---------|------|------|-------|
| 1       | 9999 | 300  | 01:00 |
| 2       | 100  | 350  | 00:30 |
| 3       | 350  | 1350 | 01:30 |
| 4       | 300  | 900  | 99:99 |

### USER 6: Slow Cooling Cycle for Cone 6 Glazes

| Segment | Rate | degF | Hold  |
|---------|------|------|-------|
| 1       | 9999 | 2232 | 00:00 |
| 2       | 9999 | 1900 | 00:00 |
| 3       | 150  | 1500 | 00:00 |

**APPENDIX J**  
***FIRING PROGRAM BLANK***

Firing Program Number: \_\_\_\_\_

| <b>Segment</b> | <b>Rate</b> | <b>Temperature</b> | <b>Hold</b> |
|----------------|-------------|--------------------|-------------|
| 1              |             |                    |             |
| 2              |             |                    |             |
| 3              |             |                    |             |
| 4              |             |                    |             |
| 5              |             |                    |             |
| 6              |             |                    |             |
| 7              |             |                    |             |
| 8              |             |                    |             |

Firing Program Number: \_\_\_\_\_

| <b>Segment</b> | <b>Rate</b> | <b>Temperature</b> | <b>Hold</b> |
|----------------|-------------|--------------------|-------------|
| 1              |             |                    |             |
| 2              |             |                    |             |
| 3              |             |                    |             |
| 4              |             |                    |             |
| 5              |             |                    |             |
| 6              |             |                    |             |
| 7              |             |                    |             |
| 8              |             |                    |             |



CONES, LOGS, TIPS

*The Low Fire 70  
Litre (2.5 cu ft) kiln  
that plugs into a  
230 volt 13 amp  
home circuit.*

**The ROBIN**



# Temperature Equivalent Chart for Orton Pyrometric Cones (° F) Cone Numbers 022-14



| Cone | Self Supporting Cones |      |           |      |   |      | Large Cones |           |         | Small     |         |           |
|------|-----------------------|------|-----------|------|---|------|-------------|-----------|---------|-----------|---------|-----------|
|      | Regular               |      | Iron Free |      | Heating Rate ° F/hour (last 180° F of firing) |      | Regular     | Iron Free | Regular | Iron Free | Regular | Iron Free |
|      | 27                    | 108  | 270       | 108  | 270   | 108  | 270         | 108       | 270     | 540       | 540     |           |
| 022  |                       | 1087 | 1094      |      |   |      | N/A         | N/A       |         |           | 1166    |           |
| 021  |                       | 1112 | 1143      |      |   |      | N/A         | N/A       |         |           | 1189    |           |
| 020  |                       | 1159 | 1180      |      |   |      | N/A         | N/A       |         |           | 1231    |           |
| 019  | 1213                  | 1252 | 1283      |      |   |      | 1249        | 1279      |         |           | 1333    |           |
| 018  | 1267                  | 1319 | 1353      |      |   |      | 1314        | 1350      |         |           | 1386    |           |
| 017  | 1301                  | 1360 | 1405      |      |   |      | 1357        | 1402      |         |           | 1443    |           |
| 016  | 1368                  | 1422 | 1465      |      |   |      | 1416        | 1461      |         |           | 1517    |           |
| 015  | 1382                  | 1456 | 1504      |      |   |      | 1450        | 1501      |         |           | 1549    |           |
| 014  | 1395                  | 1485 | 1540      |      |   |      | 1485        | 1537      |         |           | 1598    |           |
| 013  | 1485                  | 1539 | 1582      |      |   |      | 1539        | 1578      |         |           | 1616    |           |
| 012  | 1549                  | 1582 | 1620      |      |   |      | 1576        | 1616      |         |           | 1652    |           |
| 011  | 1575                  | 1607 | 1641      |      |   |      | 1603        | 1638      |         |           | 1679    |           |
| 010  | 1636                  | 1657 | 1679      | 1600 | 1627  | 1639 | 1648        | 1675      | 1623    | 1636      | 1686    |           |
| 09   | 1665                  | 1688 | 1706      | 1650 | 1686  | 1702 | 1683        | 1702      | 1683    | 1699      | 1751    |           |
| 08   | 1692                  | 1728 | 1753      | 1695 | 1735  | 1755 | 1728        | 1749      | 1733    | 1751      | 1801    |           |
| 07   | 1764                  | 1789 | 1809      | 1747 | 1780  | 1800 | 1783        | 1805      | 1778    | 1796      | 1846    |           |
| 06   | 1798                  | 1828 | 1855      | 1776 | 1816  | 1828 | 1823        | 1852      | 1816    | 1825      | 1873    |           |
| 05½  | 1839                  | 1859 | 1877      | 1814 | 1854  | 1870 | 1854        | 1873      | 1852    | 1868      | 1909    |           |
| 05   | 1870                  | 1888 | 1911      | 1855 | 1899  | 1915 | 1886        | 1915      | 1890    | 1911      | 1944    |           |
| 04   | 1915                  | 1945 | 1971      | 1909 | 1942  | 1956 | 1940        | 1958      | 1940    | 1953      | 2008    |           |
| 03   | 1960                  | 1987 | 2019      | 1951 | 1990  | 1999 | 1987        | 2014      | 1989    | 1996      | 2068    |           |
| 02   | 1972                  | 2016 | 2052      | 1983 | 2021  | 2039 | 2014        | 2048      | 2016    | 2035      | 2098    |           |
| 01   | 1999                  | 2046 | 2080      | 2014 | 2053  | 2073 | 2043        | 2079      | 2052    | 2070      | 2152    |           |
| 1    | 2028                  | 2079 | 2109      | 2046 | 2082  | 2098 | 2077        | 2109      | 2079    | 2095      | 2163    |           |
| 2    | 2034                  | 2088 | 2127      |      |   |      | 2088        | 2124      |         |           | 2174    |           |
| 3    | 2039                  | 2106 | 2138      | 2066 | 2109  | 2124 | 2106        | 2134      | 2104    | 2120      | 2185    |           |
| 4    | 2086                  | 2124 | 2161      |      |   |      | 2120        | 2158      |         |           | 2208    |           |
| 5    | 2118                  | 2167 | 2205      |      |   |      | 2163        | 2201      |         |           | 2230    |           |
| 5½   | 2133                  | 2197 | 2237      |      |   |      | 2194        | 2233      |         |           | N/A     |           |
| 6    | 2165                  | 2232 | 2269      |      |   |      | 2228        | 2266      |         |           | 2291    |           |
| 7    | 2194                  | 2262 | 2295      |      |   |      | 2259        | 2291      |         |           | 2307    |           |
| 8    | 2212                  | 2280 | 2320      |      |   |      | 2277        | 2316      |         |           | 2372    |           |
| 9    | 2235                  | 2300 | 2336      |      |   |      | 2295        | 2332      |         |           | 2403    |           |
| 10   | 2284                  | 2345 | 2381      |      |   |      | 2340        | 2377      |         |           | 2426    |           |
| 11   | 2322                  | 2361 | 2399      |      |   |      | 2359        | 2394      |         |           | 2437    |           |
| 12   | 2345                  | 2383 | 2419      |      |   |      | 2379        | 2415      |         |           | 2471    |           |
| 13   | 2389                  | 2428 | 2458      |      |   |      | 2410*       | 2455*     |         |           | N/A     |           |
| 14   | 2464                  | 2489 | 2523      |      |   |      | 2491*       | 2530*     |         |           | N/A     |           |

Pyrometric cones have been used to monitor ceramic firings for more than 100 years. They are useful in determining when a firing is complete, if the kiln provided enough heat, if there was a temperature difference in the kiln or if a problem occurred during the firing.

Cones are made from carefully controlled compositions. They bend in a repeatable manner (over a relatively small temperature range - usually less than 40° F). The final bending position is an indication of how much heat was absorbed.

### Behavior of Pyrometric Cones

Typically, it takes 15 to 25 minutes for a cone to bend once it starts. This depends on the cone number. The cone bends slowly at first but once it reaches the half way point (3 o'clock), it bends quickly. When the cone tip reaches a point level with the base, it is considered properly fired. This is the point for which temperature equivalents are determined. Differences between a cone touching the shelf and a cone at the 4 o'clock position are small, usually 1 or 2 degrees.

Temperatures shown on the charts were determined under controlled firing conditions in electric kilns and an air atmosphere. Temperatures are shown for specific heating rates. These heating rates are for the last 100° C or 180° F of the firing. Different heating rates will change the equivalent

temperature. The temperature will be higher for faster heating rates and lower for slower heating rates.

Cone bending may also be affected by reducing atmospheres or those containing sulfur oxides. Orton recommends the use of Iron-Free cones for all reduction firings (cones 010-3). If a cone is heated too fast, the cone surface fuses and binders used to make cones form gases that bloat the cone. If cones are to be fired rapidly, they should be calcined (pre-fired) before use. Cones should be calcined to about 850° F (455° C) in an air atmosphere.

If a cone is soaked at a temperature near its equivalent temperature, it will continue to mature, form glass and bend. The time for the cone to bend depends on several factors and as a general rule, a 1 to 2 hour soak is sufficient to deform the next higher cone number. A soak of 4 to 6 hours will be required to deform two higher (hotter) cones.

for more information on pyrometric cones, contact Orton or visit us at [www.ortonceramic.com](http://www.ortonceramic.com)



The Edward Orton Jr. Ceramic Foundation  
 P.O. Box 2760 • Westerville, OH 43086-2760  
 (614) 895-2663 • (614) 895-5610 fax  
[info@ortonceramic.com](mailto:info@ortonceramic.com)  
[www.ortonceramic.com](http://www.ortonceramic.com)

These tables provide a guide for the selection of cones. The actual bending temperature depends on firing conditions. Once the appropriate cones are selected, excellent, reproducible results can be expected. Temperatures shown are for specific mounted height above base. For Self Supporting - 1 3/4"; for Large - 2"; for Small - 1 5/16". For Large Cones mounted at 1 3/4" height, use Self Supporting temperatures. \* These Large Cones have different compositions and different temperature equivalents.

# Temperature Equivalent Chart for Orton Pyrometric Cones (°C) Cone Numbers 022-14



| Cone | Self Supporting Cones                        |      |      |           |      |      | Large Cones |       |      | Small     |      |
|------|--|------|------|-----------|------|------|-------------|-------|------|-----------|------|
|      | Regular                                      |      |      | Iron Free |      |      | Regular     |       |      | Iron Free |      |
|      | Heating Rate °C/hour (last 100° C of firing) |      |      |           |      |      |             |       |      |           |      |
|      | 15   | 60   | 150  | 15        | 60   | 150  | 60          | 150   | 60   | 150       | 300  |
| 022  |  | 586  | 590  |           |      | N/A  | N/A         | N/A   |      |           | 630  |
| 021  |  | 600  | 617  |           |      | N/A  | N/A         | N/A   |      |           | 643  |
| 020  |  | 626  | 638  |           |      | N/A  | N/A         | N/A   |      |           | 666  |
| 019  | 656  | 678  | 695  |           |      | 676  | 693         |       |      |           | 723  |
| 018  | 686  | 715  | 734  |           |      | 712  | 732         |       |      |           | 752  |
| 017  | 705  | 738  | 763  |           |      | 736  | 761         |       |      |           | 784  |
| 016  | 742  | 772  | 796  |           |      | 769  | 794         |       |      |           | 825  |
| 015  | 750  | 791  | 818  |           |      | 788  | 816         |       |      |           | 843  |
| 014  | 757  | 807  | 838  |           |      | 807  | 836         |       |      |           | 870  |
| 013  | 807  | 837  | 861  |           |      | 837  | 859         |       |      |           | 880  |
| 012  | 843  | 861  | 882  |           |      | 858  | 880         |       |      |           | 900  |
| 011  | 857  | 875  | 894  |           |      | 873  | 892         |       |      |           | 915  |
| 010  | 891  | 903  | 915  | 871       | 886  | 893  | 898         | 913   | 884  | 891       | 919  |
| 009  | 907  | 920  | 930  | 899       | 919  | 928  | 917         | 928   | 917  | 926       | 955  |
| 008  | 922  | 942  | 956  | 924       | 946  | 957  | 942         | 954   | 945  | 955       | 983  |
| 007  | 962  | 976  | 987  | 953       | 971  | 982  | 973         | 985   | 970  | 980       | 1008 |
| 006  | 981  | 998  | 1013 | 969       | 991  | 998  | 995         | 1011  | 991  | 996       | 1023 |
| 05½  | 1004   | 1015 | 1025 | 990       | 1012 | 1021 | 1012        | 1023  | 1011 | 1020      | 1043 |
| 005  | 1021   | 1031 | 1044 | 1013      | 1037 | 1046 | 1030        | 1046  | 1032 | 1044      | 1062 |
| 004  | 1046   | 1063 | 1077 | 1043      | 1061 | 1069 | 1060        | 1070  | 1060 | 1067      | 1098 |
| 003  | 1071   | 1086 | 1104 | 1066      | 1088 | 1093 | 1086        | 1101  | 1087 | 1091      | 1131 |
| 002  | 1078   | 1102 | 1122 | 1084      | 1105 | 1115 | 1101        | 1120  | 1102 | 1113      | 1148 |
| 001  | 1093   | 1119 | 1138 | 1101      | 1123 | 1134 | 1117        | 1137  | 1122 | 1132      | 1178 |
| 1    | 1109   | 1137 | 1154 | 1119      | 1139 | 1148 | 1136        | 1154  | 1137 | 1146      | 1184 |
| 2    | 1112   | 1142 | 1164 |           |      |      | 1142        | 1162  |      |           | 1190 |
| 3    | 1115   | 1152 | 1170 | 1130      | 1154 | 1162 | 1152        | 1168  | 1151 | 1160      | 1196 |
| 4    | 1141   | 1162 | 1183 |           |      |      | 1160        | 1181  |      |           | 1209 |
| 5    | 1159   | 1186 | 1207 |           |      |      | 1184        | 1205  |      |           | 1221 |
| 5½   | 1167   | 1203 | 1225 |           |      |      | 1201        | 1223  |      |           | N/A  |
| 6    | 1185   | 1222 | 1243 |           |      |      | 1220        | 1241  |      |           | 1255 |
| 7    | 1201   | 1239 | 1257 |           |      |      | 1237        | 1255  |      |           | 1264 |
| 8    | 1211   | 1249 | 1271 |           |      |      | 1247        | 1269  |      |           | 1300 |
| 9    | 1224   | 1260 | 1280 |           |      |      | 1257        | 1278  |      |           | 1317 |
| 10   | 1251   | 1285 | 1305 |           |      |      | 1282        | 1303  |      |           | 1330 |
| 11   | 1272   | 1294 | 1315 |           |      |      | 1293        | 1312  |      |           | 1336 |
| 12   | 1285   | 1306 | 1326 |           |      |      | 1304        | 1324  |      |           | 1355 |
| 13   | 1310   | 1331 | 1348 |           |      |      | 1321*       | 1346* |      |           | N/A  |
| 14   | 1351   | 1365 | 1384 |           |      |      | 1366*       | 1388* |      |           | N/A  |

Pyrometric cones have been used to monitor ceramic firings for more than 100 years. They are useful in determining when a firing is complete, if the kiln provided enough heat, if there was a temperature difference in the kiln or if a problem occurred during the firing.

Cones are made from carefully controlled compositions. They bend in a repeatable manner (over a relatively small temperature range - usually less than 40° F). The final bending position is an indication of how much heat was absorbed.

### Behavior of Pyrometric Cones

Typically, it takes 15 to 25 minutes for a cone to bend once it starts. This depends on the cone number. The cone bends slowly at first but once it reaches the half way point (3 o'clock), it bends quickly. When the cone tip reaches a point level with the base, it is considered properly fired. This is the point for which temperature equivalents are determined. Differences between a cone touching the shelf and a cone at the 4 o'clock position are small, usually 1 or 2 degrees.

Temperatures shown on the charts were determined under controlled firing conditions in electric kilns and an air atmosphere. Temperatures are shown for specific heating rates. These heating rates are for the last 100° C or 180° F of the firing. Different heating rates will change the equivalent

temperature. The temperature will be higher for faster heating rates and lower for slower heating rates.

Cone bending may also be affected by reducing atmospheres or those containing sulfur oxides. Orton recommends the use of Iron-Free cones for all reduction firings (cones 010-3). If a cone is heated too fast, the cone surface fuses and binders used to make cones form gases that bloat the cone. If cones are to be fired rapidly, they should be calcined (pre-fired) before use. Cones should be calcined to about 850° F (455° C) in an air atmosphere.

If a cone is soaked at a temperature near its equivalent temperature, it will continue to mature, form glass and bend. The time for the cone to bend depends on several factors and as a general rule, a 1 to 2 hour soak is sufficient to deform the next higher cone number. A soak of 4 to 6 hours will be required to deform two higher (hotter) cones.

For more information on pyrometric cones, contact Orton or visit us at [www.ortonceramic.com](http://www.ortonceramic.com)



The Edward Orton Jr. Ceramic Foundation  
 P.O. Box 2760 • Westerville, OH 43086-2760  
 (614) 895-2663 • (614) 895-5610 fax  
 info@ortonceramic.com  
 www.ortonceramic.com

These tables provide a guide for the selection of cones. The actual bending temperature depends on firing conditions. Once the appropriate cones are selected, excellent, reproducible results can be expected. Temperatures shown are for specific mounted height above base. For Self Supporting - 1 3/4"; for Large - 2"; for Small - 1 5/16". For Large Cones mounted at 1 3/4" height, use Self Supporting temperatures. \* These Large Cones have different compositions and different temperature equivalents.

## What Cone Numbers Mean: Why You Should Care

The pyrometric cones used today by ceramic artists and industrial manufacturers were developed in the late 1800's by Edward Orton Jr. Dr. Orton recognized that ceramists needed a way to determine when their ware was fired correctly to develop the properties they required in their finished products. Thus all ceramic products were assigned a cone number to which they were to be fired to assure maturity of the ware during the firing process such as Cone 06 glazes, Cone 04 bodies, etc. Later, the development of electronic temperature controllers simplified the control of the firing process, but they could not replace the cones as a measure of the accumulative effect of time and temperature on the ceramic ware. An interesting parallel to this principle would be the cooking of a turkey in your electric oven. You can set the oven temperature to 350 degrees Fahrenheit and place the turkey in the oven and estimate how long to cook it to attain an internal temperature of 180 degrees Fahrenheit. However if you want to be assured the turkey reaches the desired internal temperature you can place a meat thermometer into the turkey and it will tell when you have reached the desired internal temperature. Changing the oven temperature will surely effect the time required to reach the desired internal temperature. Cones serve a similar purpose in the firing of ceramics.

Both the Orton and the Bartlett electronic temperature controllers' cone-fire programs were developed based on the actual firing behavior of Orton cones and would not work without the information on cone behavior provided by the Orton Ceramic Foundation. These controllers automatically adjust the final firing temperature based on the actual heating rate of the kiln so that the kiln delivers the correct amount of heat work specified by the cone number program selected. Therefore the most efficient and reliable way to fire your kiln is to utilize the cone-fire programs built into your controller.

However, the electronic controller is not the ultimate answer for assurance that your ware has been fired correctly. The electronic controller measures the temperature inside the kiln via the thermocouple that is usually mounted in the side wall of the kiln and extending into the kiln 1 to 1½ inches. The thermocouple is great for measurement of temperature at a point in space and a point in time and provides the controller feedback needed to control the firing cycle. But heat work is a function of both temperature and time as measured by the bending of pyrometric cones.

Why is it so important to know if you have attained the correct cone firing? Look at the label on your glaze jar. The odds are that the glaze is specified as a "Cone X" glaze. The unstated instruction for firing such a glaze is to "apply heat work equal to the cone number specified and the glaze will be properly matured". The glaze manufacturer has developed the glaze formula to mature at a certain cone number. The glaze manufacturer has conducted sufficient testing to know the fired characteristics of the mature glaze as related to glaze fit to the body, color development, the chemical resistance of the glaze surface, food-safe, etc. Under-firing or over-firing can prevent the glaze from attaining the appearance and properties you expect.

Since the thermocouple and the controller do not measure heat work how do you know if you actually matured the glaze in every firing? The thermocouple measures the temperature near the wall of the kiln where the heating elements are located and unfortunately has no means of measuring the temperature within the setting of the ware in the kiln and therefore cannot confirm if the distribution of heat work was uniform throughout the kiln. Remember the turkey story? One could fire the kiln with such a long firing cycle that all areas within the kiln received the desired

amount of heat work, but this practice could require additional kilns to meet firing needs and the energy consumption would be wasteful. A definite overkill approach without merit. The programmable controller, coupled with the use of pyrometric cones, allows for the development of firing profiles to meet all your firing conditions. Since most shop operators want to have their kiln fully utilized during each firing, we will consider a fully loaded kiln of glazed ware to be fired to cone 06. The load placed in the kiln has a direct bearing on the firing profile required to successfully fire your ware. Select the cone-fire program consistent with the recommendation of the glaze manufacturer, in this case cone 06. Remember that selecting a cone-fire program alone does not insure that you will obtain uniform heat distribution throughout your ware. The controller is designed to compensate if the kiln is heating slower than the expected rate, but only at the tip of the thermocouple, it has no information about what is occurring in the interior of the ware setting. Place a series of three cones, 07, 06, 05 (self-supporting cones are the most convenient to use) one series located on the outside perimeter of the ware setting, and the second series located in the center of the ware setting on each shelf in the kiln (commonly referred to as "witness cones"). Fire the kiln. Once cool, remove the cones marking their location in the kiln. If the cone 06 is bent so that the tip is at the same level as the top of the foot of the cone in all locations, congratulations, you have just achieved a successful firing to cone 06. **See Figure 1.**

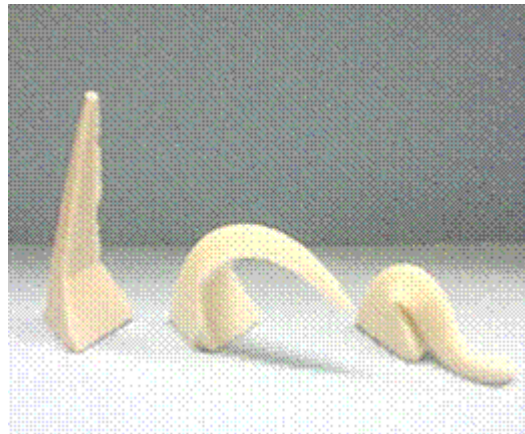

*Cone 05    Cone 06    Cone 07*  
**Figure 1.** Cone 07 is over-fired and cone 06 indicates a successful cone 06 firing.

If some of the locations indicate that you did not reach cone 06, the tip of cone 06 is not bent enough, you will need to modify your firing cycle on your controller. By having cone 07 along side cone 06 you can determine by how much you failed to reach a cone 06 firing. Cone 07 measures a lesser amount of heat work than cone 06, therefore if cone 07 is bent so that the tip is at the same level as the top of the foot of the cone you are only one cone away from the desired heat work. **See Figure 2.** There are two simple ways to correct poor heat distribution within your kiln. First, for your cone-fire program if you selected either *fast*(#1) or *standard*(#2) heating speeds try *slow*(#3), which will allow more time during the firing cycle for the heat to equalize in the ware setting, or you can add additional *hold time* (soak) at the final cone temperature. A combination of both may be necessary depending on how heavily the kiln is loaded. Your kiln manufacturer or your controller manufacturer can be a good resource for suggestions to improve your firing program. The first question you will likely be asked is "what do your witness cones show". Repeat the procedure above once the change(s) to the firing cycle have been made.

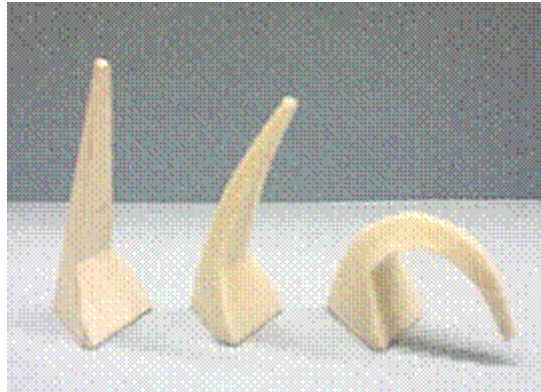

*Cone 05   Cone 06   Cone 07*

**Figure 2.** Cone 06 has not reached the proper bending angle, indicating an under-fired condition.

Since minor under-firing may not be obvious to the eye, the use of cones in every firing will alert you if there is a potential problem with the correct amount of heat work being delivered uniformly to your ware. And, when the cones confirm a successful firing, you can sleep a little better knowing you have taken a proactive, safe approach to providing your customers a high quality firing process. Retaining the cones constitutes physical proof that the ware was fired according to the glaze manufacturer's specification.

For more information on the use of pyrometric cones and the firing of ceramics please visit the Edward Orton Jr. Ceramic Foundation on the internet at [www.Ortonceramic.com](http://www.Ortonceramic.com).



# TROUBLESHOOTING KILN FIRING WITH CONE PACKS

## **BASIC CONE INFORMATION**

### **PYROMETRIC CONES**

Pyrometric cones are made of clay and other minerals and are precisely formulated to soften when fired in a kiln. They will bend over when they have absorbed a certain amount of heat. The amount of heat is related to both time and temperature. They mirror fairly accurately what goes on in ceramic body and so can be a more reliable guide to firing than a thermocouple instrument. Differing materials in the cones result in different firing temperatures. The cones you are likely to use in an L&L kiln are numbered from Cone 022 to Cone 10 (coldest to hottest). The number is imprinted on the cone. Usually clay and glaze comes with a recommended cone to fire to. A cone is a tall (about 2-1/2") pyramid made from specific damp-pressed ceramic materials. Each cone has a slight lean to it when placed on a flat surface. Be careful not to drop or expose to moisture your cones.

### **CONES MEASURE HEAT-WORK**

Cones are not temperature measuring devices. They measure how much heat has been absorbed by the ware in the kiln, which is the result of the combination of time and temperature. A particular piece of clay needs a certain amount of time at a specific temperature to properly fire it, lower temperature if the time is longer, higher temperature if the time is shorter. An example of this would be if you added about a 20 minute hold to the maximum temperature of a cone 6 firing, you would be able to lower that final temperature by about 20°F. An hour hold time would mean a final temperature of about 40°F lower. A two hour hold time, about 60°F lower.

### **LARGE SELF SUPPORTING CONES**

Although there are various types of cones available we recommend using the "self-supporting large cones". They have a built-in base that allows the cone to sit flat while always placing the pyramid part of it at the proper angle. The angle is there to ensure that the cone bends in the direction you want it to, and doesn't just slump and puddle.

### **CONES FOR DAWSON KILN SITTERS**

There are "small cones" and "bars" available for use in kiln-sitters and in automatic shut-off devices. Small cones are shaped like standard cones but are only about 1" long. They are meant to melt in the kiln-sitter mechanism and activate the shut-off device. The "bars" make it easier for them to be placed properly in the mechanism, as the cones are tapered, and improper placement can result in a slight over-fire or under-fire of the ware. These cones should never be expected to mimic the results of standard or self-supporting cones unless they are used in the kiln-sitter. Gravity works differently on them because their physical size is smaller, and therefore they will melt at a considerably higher temperature than a large cone of the same cone number when they are placed side-by-side.

### **CONE PACKS**

The best way to use the cones, especially if they are all you have to tell how hot your kiln is getting, is to use 'cone packs', or the three cone system. The three cones are placed in a line, aimed so that when they fall, they will fall in a line. The first cone to fall should be in the front of the three cone line. This cone should be one cone number lower than the one you wish to fire to. The target cone (the cone you wish to fire to) should be the next one to fall and should be in the middle. The last cone should be one cone number higher than the target cone. The first cone is to warn you that the firing is almost done. The target cone tells you when to turn off the kiln, and the last cone tells you if the kiln got hotter than you thought it did.

*Picture of a "cone pack" (Courtesy of Orton). The ones in the back are before the firing and the ones in the front are after a perfect firing/ These are Self-Supporting Large Cones.*



# TROUBLESHOOTING KILN FIRING WITH CONE PACKS

## USE CONES TO CONTROL ACCURACY IN AN AUTOMATIC KILN

We recommend checking the accuracy of your control and thermocouples every so often by placing at least one large cone (the target cone or cone number you are firing to) in the top, middle and bottom. Thermocouples will drift in their accuracy, but you can adjust the cone offset or thermocouple offset (or both) to compensate for this. You know how many degrees off the thermocouple reads at the end of the firing. Using a cone near the thermocouple and a “cone to temperature chart” will help to calibrate a thermocouple accurately. Remember though, cone temperatures are affected by their location in the kiln, the angle at which they are held, and the rate at which they are heated. Slight variations throughout the kiln should be expected.

### CONE CHART

You can see a “cone to temperature” chart in the LOG, CONES, TIPS, CERAMIC PROCESS section of your manual. There is far more detailed information on this on the Orton web site ([ortonceramics.com](http://ortonceramics.com)).

## TROUBLESHOOTING FIRING PROBLEMS

### Seems like the kiln is under-firing or over-firing slightly

1) On the next firing make up “cone packs”, one for each thermocouple. A cone pack is a set of three cones, standing in a line. The cone the firing should go to is called the target cone, and is in the middle. The one in front of it is one cone number lower, and the one behind it is one cone number higher. Pay attention to how you position the cones as they are designed to only fall in one particular direction if placed on a level surface. You do not want a lower-numbered cone stuck in the cone pack behind a higher-numbered cone because the lower-numbered one will fall first and might lean against or knock over the higher-numbered cone, which will compromise the accuracy of both cones.

2) Once the cone packs are positioned on shelves (or on a post lying on its side) and are visible through the peepholes, fire the kiln to the middle cone's number.

3) Near the end of the firing start watching the cone packs. Look for the first cone to fall over in each pack, not necessarily at the same time, but pretty close, probably in the middle zone first.

4) Now watch for the middle cone in each pack. Keep checking the DynaTrol display to be sure it does not say **CPLt**. The middle cone in each pack should start to fall at pretty much the same time in the top, middle and bottom of the kiln. When the tip of the cone touches the melted cone in front of it note the temperature readout on the display for that zone's thermocouple.

a) If the middle cones did not go down together then immediately note the differences in each thermocouple reading from the one thermocouple in the same zone as the first cone that went down. Later on, use the “thermocouple offset” feature to add or subtract degrees from each thermocouple accordingly. Use the differences between the thermocouple readings as a guide to know how much to offset each thermocouple.

b) If the three thermocouple temperatures are close enough to be reading the same thing (the middle cones did all go over at the same time), then the kiln should say **CPLt** right when the cone tips bend over and touch or just before it. If the kiln is still firing after this point, note how many degrees higher it goes before shutting itself off. Then use the “cone offset” feature to change the temperature equivalent of that cone. Subtract the same amount of degrees from the temperature equivalent that the kiln over-fired the cone by.

c) If the kiln shut itself off before bending the cones properly, you want to reprogram it and then re-start it as quickly as possible. Note the temperature at which the kiln shut down. Get from **CPLt** to **IdLE**, **tC 2**, current temperature by pressing either **START/STOP** or **ENTER**. Reprogram the same program to one cone number higher, then re-start the firing. Do these steps quickly. Now watch the middle

# TROUBLESHOOTING KILN FIRING WITH CONE PACKS

cones again and note at what temperature the cones properly bend. If they bent while you were programming then just offset the temperature by 5 or 6 degrees. Shut the kiln off once you note that temperature. Using the “cone offset” feature, add the difference of the two readings to that cone's temperature equivalent.

Note: From the factory, the settings that interpret temperature signals in the DynaTrol are hard-programmed; they will not change unless part of the microprocessor has been affected. There is a range of acceptability for the accuracy however and the cone offset feature exists to allow you to fine tune the kiln to particular sized loads. It is best to use all new thermocouples to properly tune the cone offset before individual thermocouples begin to drift. Even keeping one new thermocouple solely for calibrating the individual thermocouples will help to keep the kiln accurate.

## **CALIBRATING YOUR DYNATROL**

This is also covered in the instruction sheet called *dynatrol-basic-operation.pdf* in the OPERATION section of your manual (if you have an automatic kiln).

## **MORE INFORMATION**

### **Orton Ceramic Institute**

See [ortonceramics.com](http://ortonceramics.com) for lots of very helpful information on how to use cones and for many firing tips and great information on firing kilns. ([ortonceramics.com](http://ortonceramics.com))

You can see a “cone to temperature” chart in the LOG, CONES, TIPS, CERAMIC PROCESS section of your manual.



# THE CERAMIC FIRING PROCESS IN AN L&L KILN

## TABLE OF CONTENTS

|  |   |
|--|---|
| <b>AUTOMATIC VS MANUAL</b> .....                                 | 1 |
| <b>LOADING AND FIRING ISSUES</b> .....                           | 1 |
| LOADING KILN WITH GREENWARE .....                                | 1 |
| VENTING .....  | 1 |
| LOADING KILN WITH GLAZE WARE .....                               | 2 |
| OVERGLAZE FIRING .....   | 2 |
| SPEED OF FIRING .....  | 2 |
| SOAKING .....  | 2 |
| FIRING LOG .....   | 2 |
| APPLYING KILN WASH .....   | 2 |
| <b>WHAT HAPPENS WHEN YOU BISQUE AND GLAZE IN YOUR KILN</b> ..... | 3 |
| COMPLETE DRYING .....  | 3 |
| THE "CERAMIC CHANGE" .....                                       | 3 |
| QUARTZ INVERSION .....   | 4 |
| BURNOUT .....  | 4 |
| SINTERING .....  | 4 |
| DECOMPOSITION .....  | 4 |
| VITRIFICATION .....  | 4 |
| GLAZE SET, COOL & FREEZE .....                                   | 4 |
| <b>FOR MORE INFORMATION ABOUT FIRING CERAMICS</b> .....          | 5 |
| CERAMIC BOOKS .....  | 5 |
| MAGAZINES .....  | 5 |
| WEB RESOURCES .....  | 5 |
| ORTON TIPS .....   | 5 |

## AUTOMATIC VS MANUAL

These instructions refer to the use of our DynaTrol control "Easy-Fire" programs. If you have a manual kiln you will need to adjust the switches to achieve various cycles. See our instruction sheet on "Firing Instructions for a Manual Kiln" (*fire-manual.pdf*).

## LOADING AND FIRING ISSUES

### LOADING KILN WITH GREENWARE

When placing greenware in kiln, all pieces may touch each other. Place lids on the pieces they go with when firing to bisque, this will prevent possible distortion. It is important to place tallest pieces on the center of the shelf and work outward to the shortest pieces. This will give you complete heat circulation. Be sure the ware is totally dry before firing (unless you use a very long drying cycle). Moisture in the work can cause cracking or even an explosion. We suggest using either the **SLOW BISQUE** program for heavy loads with a Preheat time of between two to three hours or the **FAST BISQUE** program for lighter loads (again with a Preheat time of two to three hours). If you want

to make up your own program use the preset program as a guide (see Appendix F in the DynaTrol instructions (*dynatrol-instruct-blue.pdf*) for a description of the segments in the preset programs). It is not a bad idea to Preheat the kiln overnight. Its only purpose is to thoroughly dry the ware and to start the expansion of the ware to take place, so that the higher heat will not affect the ware.



Note that water turning to steam expands 1170 times and if water that is in the clay expands too fast you can explode your ware. Even though your ware may seem dry there is probably moisture in the ware that needs to be force dried. By preheating and then using a fairly slow program during heat up the danger of cracking or distortion is reduced.

### VENTING

If you are using the **Vent-Sure** automatic vent system you can turn it on and leave it on during the entire firing. If you use an automatic vent you do not normally need to prop the lid open or remove peephole plugs. If manually venting (with out a powered vent) fire in the beginning with all the peepholes out. Then put bottom peephole plugs into peepholes after the low firing is over (you will know it is over when you start to see red heat through the peepholes). You typically want to leave the top peephole out during the entire firing if you not have an automatic downdraft vent. NOTE: HEAVY GREENWARE MAY TAKE LONGER TO DRY. Be sure to use the Preheat feature in the DynaTrol for ensuring dry work. NOTE: If you have a lot of moisture in your work you may want to prop open the lid for the first hour of preheat even if you have an automatic vent system. (CAUTION: Keep in mind that propping open a lid in this way can cause the lid to crack if you are not careful and that is not covered in our warranty).

# THE CERAMIC FIRING PROCESS IN AN L&L KILN

## LOADING KILN WITH GLAZE WARE

When placing ware into the kiln to be glaze fired, we suggest that the pieces should be placed 1/2" apart, so that when they are heated and expanded (which all pieces do when being fired) there is no danger of them touching each other. If pieces are placed too close together, they may touch and stick to each other, thereby ruining both pieces of ware.

Except for placing ware the proper distance from each other and placing the ware for good heat circulation, follow the instructions for the firing of greenware. Be certain when placing ware in the kiln, that no piece while expanding, can touch the thermocouples. Use either the **FAST GLAZE** or **SLOW GLAZE** program depending on your glaze needs (experiment if you are not sure) or make up your own program. Ask the supplier of your glaze if you use a commercial glaze. There are some good firing recipes in various glaze books (including Mastering Cone 6 Glazes available from us (see the ACCESSORIES section). Your clay and glaze supplier will know the cone number that you should fire your work to.

## OVERGLAZE FIRING

When firing overglazes such as Gold, Palladium, Mother of Pearl, China Paints, etc. the kiln must be vented during the firing up to 1100°F. If you are manually venting leave the peepholes open during the venting period. (NOTE: this is if you are not using a vent system such as an L&L VENT-SURE vent system which automates the venting process). Check with your clay and glaze supplier for recommended cycles.

## SPEED OF FIRING

Although the kiln may be capable of firing relatively fast this does not mean you should fire it as fast as it is capable of firing. The speed of firing will depend on what you are trying to accomplish. Check with the glaze or clay manufacturer or supplier as to a recommended firing cycle.

## SOAKING

Soaking is holding the kiln at any given temperature for a set amount of time. The purpose is typically to get the inside of the pieces the same temperature as the outsides of the pieces. Other benefits to soaking

include smoothing out of glazed surfaces, getting rid of pin holes, or craters in the glazed surface. During the bisque firing people often hold at different points to allow the clay body to outgas more of its organic material than it would if the firing had otherwise proceeded too quickly. Holding is useful at a low temperature like 200°F (actually 150°F with thermocouple offsets that are programmed into the DynaTrol) to dry out pottery or kilnwash on shelves.

The down side to holding only happens at high temperatures, there is almost no downside to holding at low temperatures except increased firing time and slight element and thermocouple degradation from the extra firing time. At high temperatures the amount of the degradation happening to the elements and thermocouples is exponentially greater. Therefore leaving the kiln holding at a high temperature will affect the element and thermocouple life significantly.

Try soak times in the range of 5 or 10 minutes at the most. Any more and care should be exercised as the kiln may over fire. Compensating by reducing the cone's temperature in the cone offset setting, or raising the thermocouple offset can help account for a longer hold. Use witness cones that you can see through your peephole (and be sure to use dark safety glasses when doing so). If you see the cones bending (which would indicate proper heat-work achieved) then you can always turn off the control at that point manually. The Orton website has a great program available for free which helps you calculate how different temperature ramps and hold times will affect the "heat-work" and cone bending in a kiln.

## FIRING LOG

We recommend keeping a firing log. Keep track of firing times, approximate load weight, firing temperatures and notes on results of the firing. There is a sample log in the LOG, CONES, TIPS & CERAMIC PROCESS section of your manual (*log.pdf*).

## APPLYING KILN WASH

Kiln wash the floor of the kiln and the upper sides of the shelves only. Apply the kiln wash to the thickness of a post card. The only purpose of kiln wash is to prevent any glaze that drips from a piece from sticking to the floor or shelves. This saves both the

# THE CERAMIC FIRING PROCESS IN AN L&L KILN

piece and the floor or shelves. If dripping should occur, simply remove dripping and cover the spot with new kiln wash. Kiln wash is a powder mixed with water to a light creamy consistency. L&L sells kiln wash: see the included Parts List.

For the kilnwash to really protect the kiln shelves it is best to apply three separate coats. If you brush one coat on, let it dry and then brush on another, you could actually be brushing off the first in the process, so ideally each coat should be fired on. The shelf can be used while firing the kiln wash on, so theoretically you would put one coat on, load the shelves and do your test firing of the kiln. The second coat would be fired on in the first bisque and the third coat in the second bisque or first glaze (whichever comes next). Fire at least to cone 018 - hot enough to give the kiln wash enough adherence to the shelf to prevent it from coming off in the second coating. Note that some people get away fine without three firings of the kiln wash. However, we include this recommendation as a "best practice".

Here is a program that will dry the kiln wash in a hurry:

In the Vary-Fire section:

Press **Enter Prog**, Press '1'

Press **Enter**, Press '1'

Press **Enter**, Press '60'

Press **Enter**, Press '200'

Press **Enter**, Press '600' (for 6 hours, 400 for 4 hours, 800 for 8 hours etc of hold time at 200 degrees)

Press **Enter**, Press **9999**

Press **Enter**, Press **START**

## **WHAT HAPPENS WHEN YOU BISQUE AND GLAZE IN YOUR KILN**

When you fire a kiln you chemically and physically alter clay and glaze compounds in a way that, to some degree, can be anticipated and accounted for. There is quite a bit more going on during firing than meets the eye. It is useful to divide up the processing cycle into separate distinct stages or segments. The stages that clay and glaze go through in a typical firing can be divided as follows:

## **COMPLETE DRYING**

Even after you room-dry your work there will be some moisture left in the seemingly dry ware. Your ware will pick up moisture from the air, even if it is left for weeks on a warm, dry shelf. Bisque ware can also absorb moisture during glazing, and the newly applied glaze is really a very fine-grained clay coating at this point; it will retain the water it was mixed with and the water in the air until it is completely dry.

When you put this piece in the kiln it will first go through a complete drying stage. This is where any water that was in your ware evaporates and expands to 1170 times its original volume. This moisture must escape from your ware before the kiln temperature gets to 212°F. It is important that the kiln temperature climb very slowly at first, and the lid can be propped 1" with several soft pieces of firebrick or ceramic posts and the peepholes opened if there is no forced venting system. (CAUTION: Keep in mind that propping open a lid in this way can cause the lid to crack if you are not careful and that is not covered in our warranty). If you have a lot of moisture in your work you may want to prop open the lid for the first hour of preheat even if you have an automatic vent system. The amount of drying needed depends on factors such as how much mass is in the kiln and how wet the ware is. Factors that lead to a longer drying time include fine-grained clay and thick-walled ware. Be sure to use the Preheat feature in the DynaTrol which automatically sets the kiln temperature at 200°F (actually 150°F with thermocouple offsets). Preheating overnight is recommended. It is best to be conservative to prevent the ware from exploding in the kiln. After a while you will get a feel for how long is necessary. Remember to carefully vacuum out your kiln if you do get an explosion from a piece that is not fully dried.

## **THE "CERAMIC CHANGE"**

This happens to each crystal and mineral particle in the clay body. Even though water between the crystals and minerals has already evaporated (hopefully during the slow preheat time), there is still water in these crystals and minerals that is venting off. This can occur all the way until the kiln reaches red heat. Slow firing is not as critical as there are pathways for the steam to travel through where the water molecules

# THE CERAMIC FIRING PROCESS IN AN L&L KILN

between the particles used to be. Venting, however, is critical to remove the water vapor.

## QUARTZ INVERSION

This is a generic name for the twenty-odd changes quartz goes through as the temperature increases and the molecules/ particles/ atoms become increasingly mobile. Most phases that a particle of quartz goes through as the kiln is heating will reverse itself during cooling. One of the largest and quickest changes the quartz goes through is roughly at 1060°F with about a 2% increase in the size of the particles during heating. The process is reversed during cooling. Also, during cooling another 2% contraction takes place at about 439°F. This is caused by the formation of 'crystalite' in some clay bodies. There is a lot of other material in your clay besides quartz, so it is not always that important to account for the quartz while the kiln is heating up. The structure of unfired clay is full of pores and non-glass bound particles, so it can withstand the expansion of a few of its quartz particles. Once the clay is fired, though, the particles become part of a solid mass of glass. This mass is extremely intolerant of the expanding quartz particles. This is especially true in the glaze firing (even more so if the bisque was even slightly under-fired). In under-fired ware the quartz never has a chance to react with the fluxes and remains intact during a second firing, ready to expand and contract as your kiln heats and cools. This is one cause of dunting (fine cooling cracks). The glass mass simply has no room for the expanding quartz crystals.

## BURNOUT

This is the burning off of any trapped organic matter in the clay. Burnout generally takes place at and above red heat. Sufficient airflow and time are necessary to burn off all the organic matter. If a bisque piece is under-fired, or fired too quickly any unburned organic matter will bubble up through the glaze during the second firing. Even if the bisque is properly fired, there will still be some organic matter in the clay that will burn out once you pass the bisque's firing temperature. A glaze that fluxes too early will block off the exits for the gasses in the clay body and cause bloating or pitting.

## SINTERING

This is the point at which powdered clay particles will begin to form chemical bonds with each other. Although the clay is not melting yet, it is forming a lump from the powdered clay. The point at which this begins to happen is called the 'sintering point'. This, like burnout, happens right around red heat.

## DECOMPOSITION

This is where fluxes really start to react and clay and glaze ingredients are deconstructed into their basic building blocks. This process can give off gasses such as sulfur and carbon dioxide which must travel out of the clay body. Once the firing is finished and the kiln cools, reconstruction takes place and the glaze and clay body recombine into a glass.

## VITRIFICATION

This is a process that develops in the clay body during firing. At one point a piece of clay might be under-fired and at a higher point it may have good strength, but not good color; at another point it may be perfect and at another, even hotter point, the piece may warp, or melt. What is important to understand is that as the firing progresses, more and more activity is taking place on a molecular level. This is good only to a certain point, after which you are left with a warped blob, or a puddle. You want to achieve the 'glassification' of the clay. This occurs right before the clay body begins to slump. At this point the molecular bond between fluxes, quartz, silica and other materials makes the 'glass'. However, it is the formation of the long mullite crystals (which only occurs above 2000°F) from the decomposing clay crystals that gives the ware its strength.

## GLAZE SET, COOL & FREEZE

Unlike the clay body, the glaze melts completely, and the bond between it and the clay becomes more complete as the temperature rises; eventually, the glaze starts to run. Things like fluidity and surface tension are determined first by the chemistry of the glaze, then by the layer formed by the heightened interaction between the glaze and clay molecules. When the ingredients of the clay and glaze have been properly matched to each other, the nature of the molten layer between the two is such that when the



# THE CERAMIC FIRING PROCESS IN AN L&L KILN

kiln is at the maximum temperature in the firing, things like pinholes and bubbles can rise through this layer and out to the surface from the clay body within, and not remain trapped in the surface when the glaze sets and begins to cool. Once the maximum temperature is reached and the kiln begins to cool, the glaze and clay body will follow. The glaze will not solidify until some time after the kiln begins to cool. When this happens depends on the rate of cooling and the chemistry of the glaze. Right before the glaze solidifies, however, crystals can form. Depending on its chemistry, the glaze can solidify quickly and form crystals. Or, with some glazes, crystal formation can take place throughout the initial cooling until the glaze finally solidifies several hundred degrees lower than the highest temperature. By adjusting the glaze recipe slightly one can maximize or minimize the forming of crystals in the glaze during cooling. Once the glaze solidifies it is still important for the kiln to cool slowly. Crazeing (fine cracking) can occur if cooling is too rapid. Heat shock, which is usually catastrophic, is something that can happen in the kiln or a few days after; it also may occur gradually over time.

In truth, simply test-firing the kiln and the ware to be fired is usually enough to deal with the complexity of the process. Every kiln and kiln-load fires differently, and a new kiln is no exception. The use of a vent system is recommended simply because it will exhaust any detrimental particles and fumes from the kiln, circulate air in the kiln and provide an oxygen-rich atmosphere.

## FOR MORE INFORMATION ABOUT FIRING CERAMICS

---

### CERAMIC BOOKS

In addition L&L has available a book called [Electric Kiln Ceramics](#) written by Richard Zakin, a book called [What Every Potter Should Know](#) by Jeff Zamek and [Mastering Cone 6 Glazes](#) by Ron Roy and John Hesselberth. These are described in the ACCESSORIES section ([books.pdf](#)).

### MAGAZINES

The magazines *Ceramics Monthly* ([ceramic-](#)

[smonthly.org](#)) and *Clay Times* ([claytimes.com](#)) have many good articles and resources.

### WEB RESOURCES

Also check out the great web resource, the Clayart discussion group at [potters.org](#). Check the links page on our web site.

### ORTON TIPS

We include many firing tip brochures from Orton. For a more in depth explanation Orton has a great booklet called *Successful Firing Practices*. They also have a number of other booklets available such as *Cones and Firing* (20 pages), *Using Orton Cones/Temperature Charts*, *Kiln Safety Booklet*, *Kiln-Sitter Maintenance & Repair* and *Porcelain Firing Guide*. Contact Orton at 614-895-2663 for more information. See [ortonceramics.com](#) for lots of very helpful information on how to use cones and for many firing tips and great information on firing kilns. They have a great program available for free which helps you calculate how different temperature ramps and hold times will affect the “heat-work” and cone bending in a kiln.

# Firing Tips



## LOADING A KILN FOR BEST RESULTS

Loading a kiln for firing is not a simple matter of placing shelves and stacking ware. The more thought and planning that is put into loading, the better the results. Ware and shelf placement, the size of the load, the firing characteristics of the kiln and the type of ware being fired are all important factors.

### First the Furniture

Kiln shelves come in all shapes and sizes. For economy of space, it is best to choose shelves similar in shape and size to your kiln chamber. For instance, use a round or multi-sided shelf in a round or multi-sided kiln. Keep the size small enough so there is at least 1" of space between the shelf edge and the side of the kiln or the Kiln-Sitter®. Also allow some room between the top of your ware and the lid of the kiln and leave space for witness cones amongst your ware.

Select posts in heights to accommodate the ware you are firing. Leave some room between the kiln shelves for air to flow, for heat transfer and for removal of fumes.

Half shelves are very useful to improve

air movement in the kiln. Use two side by side with a 1/2" space between them and you don't lose much stacking space.

Some kiln manufacturers recommend placing shelves directly on the floor of the kiln. Most suggest using 1" posts to put the bottom up from the cooler floor. This creates an insulating layer much like a storm door.

### Setters and Stilts

Air movement in the kiln is clearly a big consideration - one of the most important when loading a kiln. Ceramics need to heat uniformly to prevent warping and stresses in the ware. Air needs to move around shelves and around individual pieces.

Plates and tiles benefit from the use of tile and plate setters or stackers. Shelf-style setters allow air to move under the large flat objects so they heat more evenly. Avoid heating large flat objects directly on the cooler shelf. If you are firing decorated tiles or plates, vertical setters economize on space, and sets can be stacked to fit even more.

**Orton**

The Edward Orton Jr.

Ceramic Foundation

PO Box 2760 • Westerville OH 43086

FIRING TIPS is a series of firing problem solvers. New TIPS are available every month. Contact your Orton supplier for your copy.

Glazed ware needs to be stilted or dry footed or the melting glaze will stick the ware to the kiln shelf, ruining both. Stilts also provide space for air to move around all sides of the ware. Porcelain and stoneware can not be stilted. The stilts embed into the ware during firing. Instead, use high fire kiln wash or silica sand on the shelf. Use prop to prevent sagging of porcelain.

### **Consider Heat Distribution**

It is important to evaluate heat flow in your kiln and to make this a consideration in loading. Use pyrometric cones to determine the heating characteristics of your kiln so you know where the hot and cooler places are. Arrange your ware with different sized pieces on the same shelf to allow better heat flow.

### **Don't Overfill**

Perhaps one of the most important factors in good fired results is enough air to mature the ware - to burn out organics in bisque and develop best colors in glazes. Shelf and ware placement and the use of setters and stilts can all help this, but here are a couple more tips:

1. When stacking bisque, invert bowls and mugs opening to opening instead of nesting - this helps air move around all sides of a piece and prevents black rings and spots in the bottom of ware.
2. Fire bisque lids and bottoms together. To get the best fit for lids, fire them on the piece they match.

This will let the two pieces shrink together so you get a good tight fit. Fire all glaze pieces separately.

3. Leave space between ware - don't overfill. There is a temptation to cram as much as possible into the kiln to economize on firing costs. Ware fired too closely together creates firing problems. If you must overfill, fire very slowly and vent adequately.
4. Mix thin and thick-walled pieces together throughout the load - don't concentrate them in one area where they are competing for air and heat.
5. Use downdraft venting to move air through the kiln and to remove fumes created during firing.

### **Want to learn more?**

Read more about Loading A Kiln in the Orton Firing Line and Technical Tips publications. Each issue is packed full of articles to help you learn more about firing. Members of the Orton Firing Institute receive these publications at no charge. Single copies are available to non-members at a per issue rate. Orton's 80 minute video, *Key Principles of Successful Firing*, is also an excellent resource on firing.

For information on Orton products, see your Orton dealer or distributor. For information on the Firing Institute or publications, contact

Orton Firing Institute, PO Box 2760,  
Westerville OH 43086, 614-895-2663.

**Orton pyrometric cones and bars • KilnVent systems  
kiln accessories and firing supplies • Orton Firing Institute**

# Firing Tips

## UNDERSTANDING HEAT TRANSFER

### How Heat is Transferred

Heat moves through the kiln from hotter to cooler zones by:

1. convection
2. conduction
3. radiation

### Convection

Convection is the first step in the heating process in the kiln. Air is heated as it passes across the warming kiln elements. As the hot air rises and cool air falls, air currents are created which circulate hot air to cooler places in kiln. This heat is transferred to the ware, shelves, etc.

The kiln will not be uniform in temperature at this early stage of firing unless the hot air is pushed through the kiln by mechanical means. Low cone firings such as 022 and 021 depend more heavily on convection for heat transfer.

The most common type of convection we are familiar with is wind chill. The cool air passes across the face and pulls heat from our warmer body, which lowers our skin temperature.

### Conduction

When heat moves through a solid, it is conducted. An example would be heat moving through the handle of a saucepan. This is a slow way to heat, but the handle will eventually get hot.

In a kiln, conduction moves heat from the inside to the outside of the kiln and from the outside to the inside of the ware. Conduction is the main way we get uniform heating in the kiln. This is a slow process and if we fire too fast, the inside of our ware will receive too little heat and not fire properly.

### Radiation

At the beginning of the firing, the elements are the hottest part of the kiln. The heat from the elements radiates out - like the sun warming us on a cool day. Eventually the firebrick and the ware will also get hot and will radiate heat as well.

As the temperature increases, more and more of the heat is transferred by radiation from the heating elements. For uniform heating, it is important that all surfaces of the ware be exposed to heating elements, even partially.

**Orton**

The Edward Orton Jr.  
Ceramic Foundation

PO Box 2760 • Westerville OH 43086

FIRING TIPS is a series of firing problem solvers. New TIPS are available every month. Contact your Orton supplier for your copy.



#### 4. Time and temperature profile during the burn out period

Both time and temperature are important for proper burn out of the carbon. Some carbons require much higher temperatures than others. Oxidation should be completed below red heat (1400°F).

Carbon burns out from the surface first. As more oxygen penetrates the body, then more carbon is reacted to form the CO or CO<sub>2</sub> gas and the burn out process continues. If there is sufficient time, temperature and oxygen, then complete burn out occurs. If these conditions do not exist, the resulting incomplete burn out is referred to as black coring (where the center of the piece has a black or gray cast).

### **Incomplete Burn Out**

Incomplete burn out can result in several firing problems including:

#### 1. Bloating of the ware

If the temperature is hot enough, the outside of the piece will seal up before all the gases can escape. As the body becomes plastic due to glass forming, gases trapped inside the body expand with heat and cause bloating and sometimes cracking of the ware.

#### 2. Glaze defects, such as pinholes

The escaping gases will push through the glaze surface and cause hubbles which pop. If these do not heal, then pinholes will result.

#### 3. Appearance of fired bisque

Where carbon burn out is incomplete, the piece will have a grayish cast (white bodies) or may have a greenish cast (red bodies). The body will also be more porous and weak.

### **Preventing Incomplete Burnout**

1. Slow down the firing.
2. Be sure the kiln is vented adequately so there is sufficient oxygen.
3. Load the kiln with burn out requirements in mind.

Leave plenty of space between ware and shelves. Do not stack ware. Use tile and plate stackers and invert pieces on top of one another to help conserve space and insure proper burnout.

### **Want to learn more?**

Read more about carbon related glaze and body defects in the Orton Firing Line and Technical Tips publications. Each issue is packed full of articles to help you learn more about firing. Members of the Orton Firing Institute receive these publications at no charge. Single copies are available to non-members at a per issue rate. Orton's 80 minute video, *Key Principles of Successful Firing*, is also an excellent resource on firing.

For information on Orton products, see your Orton dealer or distributor. For information on the Firing Institute or publications, contact

Orton Firing Institute, PO Box 460,  
Westerville OH 43086, 614-895-2663.

# Firing Tips

## CRACKING AND THERMAL SHOCK

Cracks that appear in fired ware which were not caused by casting or drying problems may be the result of thermal shock.

Thermal shock occurs when too much stress is created in a piece of ware during the heating and cooling process. It comes from temperature differences in the ware and can cause small to large cracks in the piece, or the piece may actually break.

### Why Does Cracking Occur?

The tendency of a piece of be susceptible to thermal shock is related to:

- the strength of the piece
- the thermal expansion of the material

Thermal shock can result when changes in temperature occur in the kiln during heating and cooling. As temperature changes rapidly, the outside of the ware and kiln furniture becomes much hotter or cooler than the inside. This causes stresses which may result in cracking or breaking.

The following can effect thermal shock

- a fast heating rate or rapid cooling
- a sudden influx of cool air such as opening the kiln lid when the kiln has not finished cooling
- in a gas kiln - turning off the gas and allowing cool air from the burners to enter the kiln

Thermal shock can also occur when ware is stressed in use such as a casserole or dish that is taken from the freezer or refrigerator and put into a hot oven.

The stronger ware is, the better able it is to resist cracks due to thermal shocking. Weak ware will be more likely to break when stressed.

A piece that is porous will also be weaker, making it easier to crack. Water or condensation that enters pores in the ware can turn into steam and expand and this can cause cracking when heated. The harder (hotter) ware is fired, the less porous it will be.

Ware that expands and shrinks a great deal during heating and cooling is also more likely to be affected by thermal shock. Most kiln shelves contain

**Orton**

The Edward Orton Jr.  
Ceramic Foundation  
PO Box 2760 • Westerville OH 43086

FIRING TIPS is a series of firing problem solvers. New TIPS are available every month. Contact your Orton supplier for your copy.

cordierite because this material has a lower expansion than most of our ware and so less affected by thermal shock.

### **What Happens to Ware During Firing?**

During heating and cooling, the body and glaze undergo many physical and chemical changes. Some of these include:

- moisture is driven out of the ware - if this occurs too rapidly, cracking can occur
- organic material is oxidized and released from the material
- the glaze softens, melts and flows during heating and may trap gas
- the body expands as it is heated and contracts during cooling
- the glaze solidifies and contracts during cooling

If the body or glaze contains silica, it will expand rapidly at 1063°F on heating and contract during cooling. If the heating or cooling is rapid near this temperature, this change can lead to cracking of the piece.

Control of heating and cooling is especially critical when firing thick-walled pieces or pieces with an irregular wall thickness.

### **Reducing Thermal Shock**

There are several easy ways to minimize the potential for thermal shock:

- use a smooth, moderate heating rate
- let the kiln cool naturally with the lid closed

- use a controller to slow down the cooling time
- avoid sudden temperature changes

A programmable controller such as the Orton AutoFire™ is the best solution to control the heating and cooling rates and to get a smooth temperature rise.

If instrumentation is not available, heat loss during cooling can be controlled to some extent by keeping the kiln closed until well below red heat (900°F).

To be sure that ware is properly matured, be sure to use witness cones. Underfired bisque will continue to shrink during the glaze firing and this can result in a poor glaze fit.

### **Want to learn more?**

Read more about cracking and thermal shock in the Orton Firing Line and Technical Tips publications. Each issue is packed full of articles to help you learn more about firing. Members of the Orton Firing Institute receive these publications at no charge. Single copies are available to non-members at a per issue rate. Orton's 80 minute video, *Key Principles of Successful Firing*, is also an excellent resource on firing.

For information on Orton products, see your Orton dealer or distributor. For information on the Firing Institute or publications, contact

Orton Firing Institute, PO Box 2760,  
Westerville OH 43086, 614-895-2663.

**Orton pyrometric cones and bars • KilnVent systems  
kiln accessories and firing supplies • Orton Firing Institute**

# Firing Tips

## CRACKING AND WARPING CAUSED BY DRYING AND CASTING

In some instances cracking and warping problems share a common source: the casting and drying of the piece. In other cases, cracking may be related to how the piece is fired. This Tip looks at problems related to casting and drying.

### DRYING CERAMICS

Ceramics contain clay which can absorb and hold water. Before firing, it is important to remove all of the physical water so that the piece will not crack or explode when heated. This is often accomplished in steps with firing being the final stage. During firing, the chemical water is removed from the piece and it gains strength while developing physical surface characteristics.

### UNDERSTANDING DRYING

Simplified, drying is the removal of water from body by evaporation. As the ware is dried, the film of water separating the clay particles gets thinner and thinner, the solid particles get closer together and the piece shrinks. Shrinkage stops when the particles finally contact each other.

### DRYING FAULTS

Cracking, distorting and warping are problems that may not become evident until after firing. They are usually caused by drying too fast or unevenly.

If ware is heated too fast, the pressure from water vapor inside the piece can cause cracking. Ware dried only on one side, can shrink more on that side causing warping or bending of the somewhat plastic (flexible) piece. When one surface finishes drying, the piece is now too stiff to recover and the warping becomes permanent. This can lead to cracking.

Bodies made of very plastic clays or compositions having a high clay content require attention to uniform, slow drying.

Thicker walled pieces will often have a greater tendency to warp or distort.

Care needs to be taken to allow for uniform air movement around all sides of a piece to avoid drying problems. Sometimes drying must be slowed down to avoid cracking.

**Orton**

The Edward Orton Jr.  
Ceramic Foundation  
PO Box 2760 • Westerville OH 43086

FIRING TIPS is a series of firing problem solvers. New TIPS are available every month. Contact your Orton supplier for your copy.

Handles on cups can have a tendency to pull away from the mug. Doll heads and chest cavities may deform inward.

## **REDUCING WARPING AND CRACKING**

To reduce warping and cracking, take steps to dry more slowly and more evenly from all sides.

Don't dry a flat object on a wet or cool surface like a formica or plastic table top or damp newspaper. The piece can only dry on one side. Instead, dry objects on something porous like wood or plaster or set them so air can circulate around them. If necessary, turn pieces over during drying for more even result.

Slow the drying of thick walled pieces and hand built ware.

Support areas during drying that might cause stresses to build up.

## **DRYING TECHNIQUES**

**slip cast ware** - may warp or crack if stressed (deformed) when removed from the mold. Even if the ware is gently returned to the original shape, the created stress will ultimately cause the piece to warp or crack.

**wheel thrown ware** - should not distort during drying unless subjected to further mechanical forces - let the ware dry naturally on a bat or shelf and it should be fine.

**thick handbuilt ware** - needs to be

dried for a very long time before it can fired or it may explode during firing. Several days may be required or a low heat drying in an oven may be necessary to remove all the water.

**plates** - even drying is particularly important with plates. Warping can cause the center of plate to fall or arch up. Rims and centers must dry evenly to prevent warps, humps and cracks.

**drying tiles** - drying tiles can present a particular challenge because it can be difficult for the piece to dry evenly. Usually air is passed over the top of the tile. This results in warping because the bottom of the tile remains wet. Drying tiles in tile racks can help air movement for more even drying.

## **Want to learn more?**

Read more about Solving Cracking and Warping Problems in the Orton Firing Line and Technical Tips publications. Each issue is packed full of articles to help you learn more about firing. Members of the Orton Firing Institute receive these publications at no charge. Single copies are available to non-members at a per issue rate. Orton's 80 minute video, *Key Principles of Successful Firing*, is also an excellent resource on firing.

For information on Orton products, see your Orton dealer or distributor. For information on the Firing Institute or publications, contact

Orton Firing Institute, PO Box 2760,  
Westerville OH 43086, 614-895-2663.

**Orton pyrometric cones and bars • KilnVent systems  
kiln accessories and firing supplies • Orton Firing Institute**

# Firing Tips



## USING THE THREE CONE SYSTEM

All ceramic products fire within a range to develop best fired properties. Some products such as stoneware have a wide firing range. Other products such as porcelain slip and leadless glazes have a narrow firing range (less than 2 cone numbers).

To be sure ware is properly fired, it is important to understand how your kiln is firing. The Three Cone System is an excellent way to do this.

### What is the Three Cone System

The Three Cone System consists of three consecutively numbered cones:

**Firing Cone** - cone number recommended by manufacturer

**Guide Cone** - one cone number cooler

**Guard Cone** - one cone number hotter

For example: Cones 017 (guide cone), 018 (firing cone), 016 (guard cone)

### Uses for the Three Cone System

- determine temperature uniformity in the kiln
- check the performance of the Kiln-Sitter® or electronic controller
- manually shut off the kiln by direct observation of the cones bending

- evaluate heatwork that ware receives during firing

### How Witness Cones Work

Pyrometric cones indicate how much heat has been absorbed. Witness cones set on the shelf near the ware are true indicators of whether the ware received the proper amount of heat. Products are expected to be fired to a cone number or within a range of numbers. For some products, good results can be obtained at a cone lower or higher. Other products have to be fired very precisely.

### Using the Three Cone System for Manual Shut-off

By observing the witness cones during firing, the end of the firing can be determined for manual kiln shut off.

To use the Three Cone System for manual shut-off, place cones on a kiln shelf near the center of the load, but out of a draft and where they can be observed through the peephole.

When the kiln is near its firing point, the Guide cone will begin to bend. The ware is approaching maturity and soon the kiln can be shut off.

 **Orton**

The Edward Orton Jr.  
Ceramic Foundation  
PO Box 460 • Westerville OH 43081

FIRING TIPS is a series of firing problem solvers. New TIPS are available every month. Contact your Orton supplier for your copy

It takes about 15 to 20 minutes for the Firing Cone to reach it's end point. The cone bends slowly at first, and more quickly after the half way point. When the cone tip is even with the top of the cone base, it is time to shut off the kiln. If the Guard Cone bends, the desired heatwork has been exceeded.

### **Using the Three Cone system to Evaluating Kiln Performance**

Most kilns have temperature differences from top to bottom. The amount of difference depends on

- design of the kiln
- age of the heating elements
- load distribution in the kiln
- cone number being used

Usually, there will be a greater temperature difference at lower cone numbers than at higher ones. Placing a set of cones on each shelf during various firings allows you to determine the heating uniformity of your kiln for the materials you fire.

After firing, observe the cones and evaluate the heat distribution in the kiln. If only the guide cone is bent, there is less heat on that shelf. If the guard cone is bent, there is more heat on that shelf.

If you do find a difference, the heating uniformity can be improved by changing the kiln loading, adjusting switching or adding a downdraft vent system.

### **Checking Kiln-Sitter® Performance**

The Kiln-Sitter® is designed to shut off the kiln as a Small Cone or Bar deforms. Here's how it works:

- Small Cone/Bar is placed under sensing rod
- firing begins, cone/bar receives heat, begins to soften
- sensing rod presses down, cone bends with weight
- movement of rod activates shut-off

Because the cone or bar in the Kiln-Sitter® is near the kiln wall (closer to the heating elements), it may receive more heat than witness cones on the shelf. If the kiln shuts off before the witness cones have properly deformed, you may need to use the next hotter cone number in the Sitter®.

### **Witness Cones Are Like Insurance**

Cones are considered an inexpensive way to monitor your kiln and detect problems before a crisis occurs. Use Self Supporting Cones for the Three Cone System because they are the easiest to use and most consistent cones available.

### **Want to learn more?**

Read more about The Three Cone System in the Orton Firing Line and Technical Tips publications. Published 8 times a year, each issue is packed full of articles to help you learn more about firing. Members of the Orton Firing Institute receive these publications at no charge. Single copies are available to non-members at a per issue rate.

For information on Orton products, see your Orton dealer or distributor. For information on the Firing Institute or publications, contact

Orton Firing Institute, PO Box 460,  
Westerville OH 43081, 614-895-2663.

**Orton pyrometric cones and bars • KilnVent systems  
kiln accessories and firing supplies • Orton Firing Institute**

# Firing Tips

## CONES AND CONTROLLERS

Automatic controllers and shut-off devices are a convenient way to heat and turn off a kiln. But for consistent results it is still important to know how much heat the ware received. Only cones provide this information.

Witness cones set near the ware tell if the firing reached the cone value necessary to properly mature the ware. Cones also help in diagnosing firing problems.

### Advantages of Controllers

Electronic controllers have many advantages. They:

- allow heating rate control - heat up/cool down of the kiln
- permit slow down of the firing below red heat to burn out carbon and organic materials
- permit elimination of a kiln shut-off device, although some use this as a safety backup
- allow soaking of kiln at the firing temperature to get more uniformity of fired pieces or for special results
- provide more consistency from firing to firing

So with all of these advantages, why

are cones still needed?

### Firing Ceramics

Firing ceramics is much like baking food, except ceramics go to higher temperatures. When we bake, we leave food in the oven at a temperature for a certain time. A thermometer may help measure the temperature of our food or we may stick a fork in to test whether it seems right.

It is the same with firing - a combination of temperature and time "cooks" the ware. However, unlike baking we can't put our ware into a preheated kiln and poke a fork in our pot to test doneness. The next best thing is to place Pyrometric Cones near the ware to measure whether it has received enough heat.

### Firing With Cones

The bodies, glazes and decoration products we use are all formulated to be correctly fired when they have received enough heat to properly bend a cone. The companies and individuals who make and test these supplies use Orton Cones. Cones deform when they have received the

**Orton**

The Edward Orton Jr.  
Ceramic Foundation  
PO Box 2710 • Westerville OH 43081

FIRING TIPS is a series of firing problem solvers. New TIPS are available every month. Contact your Orton supplier for your copy.



right amount of heat, not just when the kiln reaches a certain temperature. In other words, cones behave just like your ware. This is why they are such good indicators of whether the ware was properly fired.

### How Controllers Work

Electronic controllers regulate power to the heating elements. They do this by comparing the temperature measured by a thermocouple with the expected temperature programmed into the controller. If the temperature is low, heat is added.

Controllers fire a kiln to a temperature. If this temperature is not measured accurately, the controller will fire the kiln improperly. Most controllers use a Type K thermocouple, which is less expensive, or a platinum thermocouple (Type S), which costs more but is more accurate and has a longer life.

### Measuring Temperature

Even brand new, a Type K thermocouple can vary from a true reading, as shown below. On the other hand, a Self-Supporting witness Cone will vary no more than 4°F.

| Variation in<br>New Thermocouples |        | Max. Cone<br>Variation |       |
|-----------------------------------|--------|------------------------|-------|
| Cone                              | Type K | Type S                 | Cones |
| 020                               | 8.5°F  | 2.9°F                  | 4°F   |
| 06                                | 13.5°F | 4.5°F                  | 4°F   |
| 6                                 | 16.6°F | 5.6°F                  | 4°F   |

This variation in the temperature measured by a thermocouple becomes even larger after the thermocouple has been used for awhile. It is not unusual for a Type K thermocouple to have an error of more than 25°F when fired to Cone 6 repeatedly. This means that more than a full cone error can be introduced.

### Using Controllers and Cones

Controllers do a good job at what they do - controlling the heating and cooling rate and providing consistency from firing to firing. However, if witness cones are not used with the controller, there is no way of determining what the actual firing conditions were, except by how the ware looks. By then, it may be too late.

### Want to learn more?

Read more about using cones and controlling a kiln in the Orton Firing Line and Technical Tips publications. Each issue is packed full of articles to help you learn more about firing. Members of the Orton Firing Institute receive these publications at no charge. Single copies are available to non-members at a per issue rate. Orton's 80 minute video, *Key Principles of Successful Firing*, is also an excellent resource on firing.

For information on Orton products, see your Orton dealer or distributor. For information on the Firing Institute, video or publications, contact

Orton Firing Institute, PO Box 2760,  
Westerville OH 43086, 614-895-2663

Orton pyrometric cones and bars • KilnVent systems  
kiln accessories and firing supplies • Orton Firing Institute

# Firing Tips

## AVOIDING CARBON BURNOUT PROBLEMS

Materials used in ceramics contain naturally occurring impurities that can affect the color, appearance and maturing temperature of the product.

Carbon, found in most clays, is normally considered one of these impurities. Carbon can also be present in the additives and binders which make up clay bodies, slips, decals and lusters.

### How Carbon Burns Out

During heating (firing) the carbon reacts with oxygen to form carbon dioxide and carbon monoxide gases. The carbon leaves the body as a gas.

Binders are burned off at a relative low temperature: 300°F to 500°F.

Naturally occurring carbon in clay burns off (become gases) at higher temperatures: up to 1200°F-1400°F.

The rate at which this carbon burns out is related to:

1. The amount of carbon present (that is, the amount of natural contaminants in the body)

Some bodies have more contaminants than others, such as red clays. This needs to be considered when planning the firing.

2. Amount of air available (air provides oxygen for burnout)  
Air needs to get to the carbon inside the body.

This is impacted by several factors. A load that is fired very quickly will not allow enough time for the oxygen to react with the carbon, form gases and leave the ware.

If ware is stacked during bisque firing, oxygen may not be able to penetrate all surfaces of or inside all the pieces.

Also, if gases are not removed from the kiln and replaced with fresh air, then there may not be sufficient oxygen to burn out the carbon.

3. Thickness of the piece

Air has to penetrate through the entire thickness of the piece and the gases have to escape the same way. It takes longer for carbon to burn out of a thicker piece of ware.

  
**Orton**

The Edward Orton Jr.  
Ceramic Foundation  
PO Box 2760 • Westerville OH 43086

FIRING TIPS is a series of firing problem solvers. New TIPS are available every month. Contact your Orton supplier for your copy.

#### 4. Time and temperature profile during the burn out period

Both time and temperature are important for proper burn out of the carbon. Some carbons require much higher temperatures than others. Oxidation should be completed below red heat (1400°F).

Carbon burns out from the surface first. As more oxygen penetrates the body, then more carbon is reacted to form the CO or CO<sub>2</sub> gas and the burn out process continues. If there is sufficient time, temperature and oxygen, then complete burn out occurs. If these conditions do not exist, the resulting incomplete burn out is referred to as black coring (where the center of the piece has a black or gray cast).

### Incomplete Burn Out

Incomplete burn out can result in several firing problems including:

#### 1. Bloating of the ware

If the temperature is hot enough, the outside of the piece will seal up before all the gases can escape. As the body becomes plastic due to glass forming, gases trapped inside the body expand with heat and cause bloating and sometimes cracking of the ware.

#### 2. Glaze defects, such as pinholes

The escaping gases will push through the glaze surface and cause bubbles which pop. If these do not heal, then pinholes will result.

#### 3. Appearance of fired bisque

Where carbon burn out is incomplete, the piece will have a grayish cast (white bodies) or may have a greenish cast (red bodies). The body will also be more porous and weak.

### Preventing Incomplete Burnout

1. Slow down the firing.
2. Be sure the kiln is vented adequately so there is sufficient oxygen.
3. Load the kiln with burn out requirements in mind.

Leave plenty of space between ware and shelves. Do not stack ware. Use tile and plate stackers and invert pieces on top of one another to help conserve space and insure proper burnout.

### Want to learn more?

Read more about carbon related glaze and body defects in the Orton Firing Line and Technical Tips publications. Each issue is packed full of articles to help you learn more about firing. Members of the Orton Firing Institute receive these publications at no charge. Single copies are available to non-members at a per issue rate. Orton's 80 minute video, *Key Principles of Successful Firing*, is also an excellent resource on firing.

For information on Orton products, see your Orton dealer or distributor. For information on the Firing Institute or publications, contact

Orton Firing Institute, PO Box 460,  
Westerville OH 43086, 614-895-2663.

# Firing Tips



## FIRING HANDBUILT OR THICK CAST WARE

Most pinch pots, coiled or slab built ware generally have thicker walls than their slip cast cousins, although molded pieces may be cast heavily as well. With these types of pieces, the thicker walls create some unique challenges for firing.

Basic problems that can occur when firing handbuilt or thick cast ware include cracking (or exploding) and carbon burnout. Because of the thicker walls it is important to fire slower and control heating and cooling during firing. Preparation of the piece is important as well.

During forming, stresses within the piece may result in hairline cracks that appear during firing. It takes longer to fully dry a thick piece. Uneven drying can result in warping or cracking.

For pieces properly prepared, handled and dried, the next critical step is firing.

### Firing issues

- Is the ware fully dry?

Ware that is not adequately dried will crack or explode during the early stages of firing. Water inside the pores of the ware turns to steam, exerting pressure inside the ware. To fully dry a thick walled piece, the ware needs to be warm for more than 12 hours.

- Am I firing too fast?

All bodies expand when heated and shrink when cooled. If the outside wall expands more than the inner wall, stresses occur. If these stresses are large enough, they pull the body apart and cause cracking. A 1" thick wall can have more than a 10°F difference in temperature between the hotter and cooler surfaces. Firings need to be slowed down for thicker wall pieces. Likewise, it is important not to cool too fast.

- Have I allowed enough time for carbon burnout?

It is important to burn out all carbon from the ware before higher temperatures are reached (1200°F or 650°C). It takes time for oxygen to move into the porous body, react with the carbon and then leave. If carbon remains, many problems can occur. These include problems with color, glaze fit, strength, blistering and discoloration. Use of a downdraft vent system, combined with slower heating, virtually eliminates carbon-related problems.

### Heating & cooling control

The best way to control cracking problems during firing is by controlling the rate of heating and cooling for the kiln.



**Orton**

The Edward Orton III Ceramic Foundation  
6921 Old 30 Highway  
Westerville OH 43081

FIRING TIPS is a series of firing problem solvers. New TIPS are available every month. Contact your Orton supplier for your copy.

During firing, materials that make up the body undergo many changes. Special care must be taken at temperatures below 1500°F (815°C) to heat the body uniformly.

Remember, the thicker the wall, the slower the heating should be done. Above 1500°F, temperatures can be increased more rapidly because the changes are less likely to cause stress cracks within the ware.

- What kind of changes occur?

All clays and many minerals contain water which does not leave the body until above 700°F. Organic (carbon) materials need to be oxidized (burned out). Other minerals, such as calcite, break down and give off a carbon dioxide gas. Minerals such as flint (silica) undergo a sudden expansion on heating to 1060°F and contraction during cooling.

- How can I control my heating?

This depends on the controls for the kiln. With switches, leave them on medium settings longer. It should take more than 3 hours to reach red heat and even longer for thick pieces or a heavily loaded kiln.

Make sure the kiln is well vented below red heat and closed up completely above red heat. Keep the kiln closed during cooling for 8 hours or until well below red heat.

- When did cracking occur?

Often the crack itself can be examined to determine when it occurred. If the edges are sharp, then it probably occurred during cooling. If the edges are rounded or if glaze has flowed into the crack, then it occurred during heating.

- What else can cause cracking?

1. Uneven heating is a primary culprit that causes cracking during firing.

Hot and cold spots in the kiln can cause uneven heating of pieces.

Use witness cones to diagnose hot and cold spots and then adjust the switching or use a downdraft vent to help even out the heating.

Careful loading of the ware in setters and on stilts can also help heat circulate around the piece.

2. Underfired bisque is not as strong and may crack more easily during the glaze firing.

Use witness cone to assure a proper firing and prevent underfired bisque.

3. Gas expanding in air pockets which developed in the ware during forming can cause large cracks during firing.

### Want to learn more?

Read more about firing handbuilt and thickcast ware in the Orton Firing Line and Technical Tips publications. Published 8 times a year, each issue is packed full of articles to help you learn more about firing. Members of the Orton Firing Institute receive these publications at no charge. Single copies are available to non-members at a per issue rate.

For information on Orton products, see your Orton dealer or distributor.

For information on the Firing Institute or publications, contact

Orton Firing Institute, 6991 Old 3C Hwy., Westerville OH 43082, 614-895-2663

Orton pyrometric cones and bars • KilnVent systems  
kiln accessories and firing supplies • Orton Firing Institute

# Firing Tips

## FIRING CERAMIC BODIES

Most bodies and glazes contain clay. These fine clay particles give the body and glaze many desired properties and bonds other materials together.

When the body is fired:

- clay and other minerals in the body start to change
- clay/minerals break down and react with other materials to produce gases
- at 900 F (red heat), tightly held water molecules begin to break free and leave
- gases such as sulfur oxides and some fluorine may be released
- as the temperature increases, clay and other minerals continue to change and react with each other to form new compounds that will be part of the final product
- some products form glass which will bond everything together

### Gases

The gases which form need to be removed from the body. For example, carbon is in the clay and organics are added to the body, glaze or decoration to improve strength during handling or application. These must be removed during firing to avoid defects.

### Firing Conditions

Firing conditions can also determine many properties of the fired product. Firing too fast at lower temperatures may not allow sufficient time for materials to react and gases to leave the body or glaze.

Firing too fast can result in

- weaker bodies
- pinholing
- bubbling of the glaze
- color changes in the body
- color changes in the decoration
- mildewing of porcelain
- crazing or peeling of glazes if body is not properly mature

### TYPES OF BODIES

#### Earthenware

- typically fired from Cone 07 - 03
- made with ta.c, less expensive clays
- clays contain many impurities, need fired longer at lower temperatures
- low shrinkage
- porous after firing
- usually tan or red in color
- frequently glazed or stained
- sometimes used as-fired.

 **Orton**

The Edward Orton Jr.  
Ceramic Foundation  
PO Box 460 • Westerville OH 43081

FIRING TIPS is a series of firing problem solvers. New TIPS are available every month. Contact your Orton supplier for your copy.

Often, problems arise because bodies are underfired. The piece may look okay, but is porous and weak. Also, underfired bodies may not match the expansion of the glaze used in a later firing. This can result in glaze fit problems or cracking of the body in use.

The high iron and carbon content of these clays requires plenty of air during firing to maintain good color and to burn out all of the carbon. If this is not done, many problems can occur when the product is glazed and refired.

### **Stoneware**

- typically fired between Cone 6 -10
- large number of compositions
- contain clays and other minerals with many impurities, including sand, feldspar and grog
- additives are used to provide plasticity, workability, strength, color and to reduce shrinkage
- colors depend on raw materials

Because of the additives and impurities, care needs to be given to how stoneware is fired and to proper ventilation of the kiln early in the firing to burn out organics.

Stoneware is vitreous and contains a high percentage of glass in the fired product. For color variations, mature the ware under reducing conditions.

### **Porcelain**

- typically fired from Cone 3 - 10
- compositions vary, but contain high quality materials
- colorants may be added.
- bodies are hard, white, translucent
- very high glass content

- narrow firing range - need to be fired close to slump or sag point for best fired properties.

Because color is very important, these bodies need to be fired with plenty of air below red heat to be sure all the carbon is removed. Shrinkage is high and special care must be given to supporting porcelain during firing or it will warp and distort.

### **CRITICAL FIRING PERIODS**

For all clay containing bodies and for most glazes and decorations:

- be sure ware is dry before firing
- fire slowly below red heat (1100 F) where many changes occur in the clay and other materials
- provide plenty of air below red heat for oxidation and to burn out organics and carbon
- do not to force cool the kiln while it shows red heat.

### **Want to learn more?**

Read more about successfully firing ceramic bodies in the Orton Firing Line and Technical Tips publications. Published 8 times a year, each issue is packed full of articles to help you learn more about firing. Members of the Orton Firing Institute receive these publications at no charge. Single copies are available to non-members at a per issue rate.

For information on Orton products, see your Orton dealer or distributor. For information on the Firing Institute or publications, contact

Orton Firing Institute, PO Box 460,  
Westerville OH 43081, 614-895-2663.

**Orton pyrometric cones and bars • KilnVent systems  
kiln accessories and firing supplies • Orton Firing Institute**

# Firing Tips

## FIRING LEAD FREE GLAZES

### Changes in glazes

Lead free glazes are becoming the standard for commercial use. This is due to government regulation and health concerns by the manufacturers.

As the name implies, lead free glazes are made from compositions or materials where lead has not been added.

To eliminate lead, glazes are reformulated. This can change some of their properties. Some of the differences you may notice include:

- does not flow or run as much in firing as lead containing glazes
- brush marks may show after firing
- not as wide a firing range
- may not be compatible with as many bodies (improper fit). This leads to shivering or crazing of the glaze.
- color does not match lead glazes
- more surface defects

For problem-free results with lead free glazes, firings must be more closely controlled and kilns well vented. Bodies may have to be bisqued to a higher or lower cone number to solve a problem.

### Why do problems occur?

Lead softens a glaze and allows it to be fired over several cone numbers. Glazes made without lead have a narrower firing range. Typically, lead glazes are able to be fired over a four cone number range (example 08 to 05).

Lead free glazes typically need to be fired within two cone numbers (example 06-05) - less than half of that for lead glazes.

### Glaze and body fit

Since the glaze and the body on which it is fired (bisque) are made from different materials, it is important that they expand and shrink a like amount when heated and cooled. If they don't, then the fired glaze can be stretched to the point where it can crack (crazing), or it can be pushed together on to itself to a point where shivering or crawling occurs.

When using lead free glazes:

1. Make test firings of the body and glaze to their recommended cone number, first the unglazed body and then the glazed bisque.

  
**Orton**

The Edward Orton Jr. Ceramic Foundation  
6901 Old 30 Highway  
Westerville, Ohio 43082

FIRING TIPS is a series of firing problem solvers. New TIPS are available every month. Contact your Orton supplier for your copy.



2. Use witness cones placed near the ware to be sure the proper cone number was reached. Differences may exist between the Kiln-Sitter® and a witness cone or from the top to the bottom of the kiln. Firing with a controller to a cone number or a temperature may not be adequate.
3. If crazing occurs and the witness cone indicates the glaze and bisque firings are properly fired, make some tests by firing the bisque progressively hotter (e.g. if you fire bisque to 05, test to 04, then 03).

When you fire hotter, the expansion of the bisque is changed and glaze on the bisque may fit better.

4. If shivering occurs, fire one cone cooler. You may need to select another body for your bisque. Firing too cool is not a good idea since the strength is reduced and porosity increased, both of which may cause problems during use of the final piece.

### **Is Your Kiln Uniform in Temperature?**

If temperature in your kiln varies by more than 1 to 2 cones, then glazed ware in one part of your kiln may fire okay, while ware fired in another part of your kiln will have a problem.

Most kilns vary in temperature from top to bottom. To determine how much your kiln varies, place witness cones on each shelf when making firings. Usually, there is less difference top to bottom for hotter firings.

Each kiln has its own personality and the solution for improving temperature uniformity may vary.

If you have glaze firing problems because

of too much variation, then we recommend the following:

1. Make sure cracks and holes are repaired to keep heat in your kiln.
2. Fire slower during the early part of your firing, before red heat (below 1200° F). This allows heat to soak into the refractory and even out temperatures in the kiln.
3. Consider changing the switching pattern to even out top and bottom temperatures. Switch the bottom to a higher setting before the top or vice versa. Higher settings add more heat.
4. Consider adding an Orton KilnVent. These pull hot gases from the top to the bottom of the kiln and cut temperature variations in half. Hoods above the kiln will not help temperature uniformity problems.

### **Want to learn more?**

Read more about glaze and body fit, heat distribution and measuring heatwork in the Orton Firing Line and Technical Tips publications. Published 8 times a year, each issue is packed full of articles to help you learn more about firing. Members of the Orton Firing Institute receive these publications at no charge. Single copies are available to non-members at a per issue rate.

For information on Orton products, see your Orton dealer or distributor.

For information on the Firing Institute or publications, contact

Orton Firing Institute, 6991 Old 3C Hwy., Westerville OH 43082  
614-895-2663.

**Orton pyrometric cones and bars • KilnVent systems  
kiln accessories and firing supplies • Orton Firing Institute**

# Firing Tips

## FIRING RED GLAZES

Red glazes are among the liveliest, brightest colors we can use, but unfortunately, red glaze problems are legendary. Many of us simply give up using reds or accept whatever results we can get, including the problems.

### Common Red Glaze Problems

**improper color development** - dark bluish or purple cast to the glaze

**color loss** - glaze looks gray, white

**poor surface texture** - a rough matte finish and/or visible surface defects

**"The Strawberry Effect"** - tiny black dots or spots in the fired glaze

**crazing** - a cracked or cracked appearance in the fired glaze

Some of these problems relate to the preparation of the piece and application of glaze, but many defects are the result of improper firing practices.

### Preparation and Application

1. ware must be clean and free of dust
2. do not apply red glaze to greenware
3. apply only to properly fired bisque (use witness cones to verify firing) -
4. work area and tools should be kept clean and free of contaminants
5. no eating/smoking in glazing area
6. glaze away from cleaning areas
7. apply adequate coats of glaze - four coats is often recommended

8. allow each coat to dry

### How Colors Develop

Many ceramic glazes need to be fired in an oxidizing (air) atmosphere for best results. Red, orange and yellow glazes in particular are very oxygen sensitive. This means they require sufficient air during the firing to bring out the colors to their fullest and to prevent surface/finish defects.

Firing reds requires us to control the firing rate and properly vent the kiln.

### Controlling the Firing Rate

Nearly all ceramics fire better when fired slowly below red heat. Slow firings have the advantage of allowing the necessary physical and chemical changes to occur in the ware. Slower firings also permit time for sufficient air to enter the kiln and displace the carbon monoxide. This is true for both bisque and glaze firings.

Firing rate can be controlled using the settings on an automatic kiln, programming an electronic controller or by adjusting the switching. Control or slowing of the firing rate is most important in the early stages of the firing when most of the reactions are occurring and when air is needed to

**Orton**

The Edward Orton Jr.

Ceramic Foundation

PO Box 2760 • Westerville OH 43086

FIRING TIPS is a series of firing problem solvers. New TIPS are available every month. Contact your Orton supplier for your copy.

burn out the organics in ceramic materials. Near vitrification (the end of the firing) a faster rate is desirable and can usually be applied.

### **Venting for Proper Air**

It is most important that enough air gets into the kiln in the early stages of firing. This is when the organic materials are burning out of the ware and air reacts with carbon to form carbon monoxide. Kilns can be vented manually or with an automatic venting system.

#### **Manual Venting**

Manual venting lets the fumes out of the kiln, but is only somewhat successful at letting air into the kiln. For manual venting, the top lid should be propped and the peephole plugs out for at least the first hour and a half. Slower firings require additional time. When the kiln reaches red heat, the lid can be closed and peephole plugs replaced. Leaving the peephole plugs out for the whole firing is not recommended since it can cause cold spots in the kiln.

Manual venting works better with a smaller load. Also, using split shelves allows air circulation and helps ventilation.

Manual venting is recommended whenever a downdraft vent is not available. When venting manually, it may be desirable to locate red glazes on the top shelf to assure sufficient air.

#### **Automatic Downdraft Venting**

A downdraft automatic venting system like the Orton KilnVent efficiently brings the proper amount of air into the

kiln and removes the fumes for exhausting. The kiln lid and peepholes remain closed the entire firing. Using the Orton Vent, tests have shown reds can even be fired with other colors with good results.

### **Firing to Proper Cone Number**

Using witness cones on the kiln shelf to verify results is important to good results. Many problems occur when red glazes are not fired to the proper cone number. Blistering can occur if underfired and loss of color if overfired. Glaze on underfired bisque may craze. Firing lead free glazes to the proper cone number is especially important.

Firing reds can be a challenge, but by following good preparation, application, firing and venting practices, and by firing to the proper cone number, most problems can be eliminated.

### **Want to learn more?**

Read more about Firing Reds in the Orton Firing Line and Technical Tips publications. Each issue is packed full of articles to help you learn more about firing. Members of the Orton Firing Institute receive these publications at no charge. Single copies are available to non-members at a per issue rate. Orton's 80 minute video, *Key Principles of Successful Firing*, is also an excellent resource on firing.

For information on Orton products, see your Orton dealer or distributor. For information on the Firing Institute or publications, contact

Orton Firing Institute, PO Box 2760,  
Westerville OH 43086, 614-895-2663.

**Orton pyrometric cones and bars • KilnVent systems  
kiln accessories and firing supplies • Orton Firing Institute**

# Firing Tips

## UNDERSTANDING CRAZING

### What is Crazing

Crazing is one of the most common problems related to glaze defects. It appears in the glazed surface of fired ware as a network of fine hairline cracks. The initial cracks are thicker and spiral upward. These are filled in horizontally with finer cracks.

Crazing is caused by the glaze being under too much tension. This tension occurs when the glaze contracts more than the body during cooling. Because glazes are a very thin coating, most will pull apart or craze under very little tension.

Crazing can make foodsafe glazes unsafe and ruin the look of a piece.

There are two types of crazing, each with a different cause:

#### immediate crazing

- appears when piece removed from kiln or shortly thereafter
- caused by glaze body fit (glaze fits too tightly to body)

#### delayed crazing

- shows up weeks/months later
- caused by moisture getting into ware

### Immediate Crazing

#### Size Changes During Firing

All ceramic bodies change in size during heating (firing) and cooling. What is desired is for the glaze to shrink a little more than the body during cooling. If it doesn't then glaze problems may occur.

It is important for ware and glaze expansion and shrinkage to match or crazing can occur.

#### Glazes During Firing

1. during firing, glaze undergoes physical and chemical changes
2. as heating progresses, glaze melts
3. with further heating more liquid forms until viscous or thick fluid
4. more heating, more fluid glaze
5. at this point, viscous (thick flowing) glaze still conforms to size of the bisque.
6. any gas evolving from body will form blisters which can heal if glaze is still fluid
7. when kiln shuts off, glaze and body cool together
8. during cooling, both the body and glaze shrink
9. eventually glaze becomes a hard glass that will no longer flow

Orton

The Edward Orton Jr.  
Ceramic Foundation  
PO Box 460 • Westerville OH 43081

FIRING TIPS is a series of firing problem solvers. New TIPS are available every month. Contact your Orton supplier for your copy.

Thermal expansion/shrinkage properties of both the body and the glaze determine if the glaze crazes.

Glazes are designed to shrink less than the body which puts them in compression, makes them stronger, and makes them less susceptible to crazing.

### **Solution to Glaze and Body Fit**

1. test samples for a good fit
2. bisque to 1-2 cone numbers hotter than glaze to insure body is mature
3. use Self-Supporting Witness Cones to verify heatwork
4. recognize that bodies and glazes will have different fits for different heatwork. A glaze might fit bisque fired to 03, but craze on 07 bisque

### **DELAYED CRAZING**

This type of crazing shows up weeks or months later and is practically always caused by underfiring.

If ware is underfired (does not reach maturity), it can, in time, expand when moisture fills the pores causing the body to expand. Sudden changes in temperature can cause crazing if the body and glaze do not expand or contract uniformly.

Either the body expanding or the glaze shrinking can cause fine hairline cracking (crazing) to occur. Refiring to the proper cone will sometimes solve the problem.

### **Proper Firing**

Firing to the proper cone number is critical to help eliminate crazing problems. Witness cones must be used

to verify the heatwork the ware receives.

If the Kiln-Sitter® turns the kiln off and a witness cone is not properly deformed, then the ware is not fired to maturity.

Underfiring can occur because of:

- variations in kiln heating uniformity
- Kiln-Sitter® out of adjustment and shutting kiln off early
- controller thermocouple inaccurate
- differences in heatwork between kiln shelf and Kiln-Sitter® location

Crazing can also be reduced by slower cooling and slower firing.

### **LEAD FREE GLAZES**

Lead-free glaze formulations today have less of firing range. They develop their fired properties more quickly and this makes proper firing more critical.

### **Want to learn more?**

Read more about crazing in the Orton Firing Line and Technical Tips publications. Published 8 times a year, each issue is packed full of articles to help you learn more about firing. Members of the Orton Firing Institute receive these publications at no charge. Single copies are available to non-members at a per issue rate.

For information on Orton products, see your Orton dealer or distributor.

For information on the Firing Institute or publications, contact

Orton Firing Institute, PO Box 460,  
Westerville OH 43081, 614-895-2663

**Orton pyrometric cones and bars • KilnVent systems  
kiln accessories and firing supplies • Orton Firing Institute**

# Firing Tips

## SOLVING GLAZE DEFECTS BLISTERS, CRATERS and PINHOLES

Blisters, craters and pinholes are related glaze surface defects. They show up as a rough, grainy or bubbled surface on the ware and appear after the glaze firing or decorating firing.

### What Causes These Defects?

This family of problems can be caused by many different factors including:

- dust and contamination in the glaze
- air bubbles in the glaze
- air trapped in the slip
- improperly mixed slip
- a dirty kiln

Most commonly, however, the problems are related to gases coming from the body, glaze or kiln atmosphere.

### What Happens During Firing?

Clays and glazes contain organic materials. When heated, these burn out of the body, forming gases such as carbon, sulfur and water.

If the carbon in materials is not fully removed from the body, then gas will form during the glaze or decorating firing, forming bubbles or blisters. These may pop to become craters or pinholes.

These defects can occur because:

1. There was not enough air in the kiln during firing for the carbon to properly burn out.

Any combustion process requires air. Without air, oxidation cannot occur.

2. Carbon monoxide formed by oxidation of carbon has not been adequately removed from kiln.

If the gases produced during firing are not removed from the kiln, they may deposit onto the glaze surface or affect the glaze color.

3. The kiln was heated so quickly that there was not enough time for the carbon to burn out.

Carbon which is only partially burned will continue to oxidize during the glaze or decorating firing causing defects.

4. The ware was underfired. That is, there was not enough heatwork.

When the body is underfired, it is weaker and its expansion may no longer fit the glaze.

 **Orton**

The Edward Orton Jr. Ceramic Foundation  
6991 Old 30 Highway  
Westerville, OH 43082

FIRING TIPS is a series of firing problem solvers. New TIPS are available every month. Contact your Orton supplier for your copy.

## How Do I Solve Glaze Defects?

To make sure that glaze defects do not occur, it is important to properly mix glazes and slips and to use good pouring (slip) and application (glaze) techniques. Proper housekeeping for the kiln and workplace should be observed. Straining glaze through nylon often helps remove any lumps.

Most critical for good results are proper firing practices. We recommend the following:

1. Bring air into the kiln and make sure it circulates around the ware especially during bisque firings:
  - use setters and stilts to improve air flow around the ware
  - use half shelves to improve air flow through the kiln
  - adequately vent the kiln
  - position ware to take best advantage of air flow in the kiln

Use a downdraft vent like the Orton KilnVent to bring a controlled amount of air into the kiln and circulate it throughout the kiln. This helps remove fumes and even out the temperatures in the kiln.

2. Control the firing.

Fire slower, especially below 1200°F (650°C). Slow down the firing by adjusting switches to lower settings or soak/hold at a temperature to allow carbon to burn out.

Use an automatic controller to set heating rates and hold times.

3. Use witness cones to verify heat-work.

Underfiring can occur due to burned out heating elements, an improperly adjusted Kiln-Sitter®, a controller thermocouple which has changed or differences in heating within the kiln. Witness cones give a true reading of the heatwork the ware received.

Witness cones placed throughout the kiln show differences in heat distribution.

4. Vent the kiln to remove gases and prevent them from redepositing on ware. Only downdraft venting removes the gases from the kiln.

If good firing and venting practices are observed during firing, problems with glaze surface defects can be controlled.

### Want to learn more?

Read more about glaze surface defects in the Orton Firing Line and Technical Tips publications. Published 8 times a year, each issue is packed full of articles to help you learn more about firing. Members of the Orton Firing Institute receive these publications at no charge. Single copies are available to non-members at a per issue rate.

For information on Orton products, see your Orton dealer or distributor.

For information on the Firing Institute or publications, contact

Orton Firing Institute, 6991 Old 3C Hwy., Westerville OH 43082, 614-895-2663.

**Orton pyrometric cones and bars • KilnVent systems  
kiln accessories and firing supplies • Orton Firing Institute**

# Firing Tips

## SUCCESSFUL GLASS FUSING

Probably the most common problem encountered when fusing glass is that it breaks during firing. There are several causes, including:

1. glass incompatibility
2. glass sticking to shelves
3. glass heated too rapidly
4. glass annealed too quickly

### **Glass Compatibility**

To be compatible, glasses must expand and contract at the same rate when heated and cooled. When this does not occur, they are considered incompatible.

If incompatible glass is fused together and then cooled, stresses will occur in the piece. If the stress is excessive, the fused glass will break either immediately upon cooling or months or even years later.

Glasses are rated using a coefficient of thermal expansion scale. This is based on the linear size change or expansion during heating.

What this means is that the amount the glass expands during heating is

measured and compared to a scale. The larger the number, the greater the expansion. Glass with low expansions will have greater resistance to thermal shock and breaking or cracking.

When you purchase glass, be sure all of the materials you are planning to use in a piece have similar expansion (coefficient) numbers.

### **Glass Sticking**

If kiln wash (shelf primer) is applied unevenly or bare patches are left, the glass may stick as it moves (expands) during the firing process. When this happens, the glass can pull itself apart and break.

Kiln wash should be cleaned off and reapplied in a thin even coating to prevent sticking problems. Take care not to use too much shelf primer as it may require sandblasting to remove it from the bottom of the fired piece.

### **Glass Heating Too Rapidly**

Thermal shocking of glass during

**Orton**

The Edward Orton Jr.  
Ceramic Foundation  
PO Box 2760 • Westerville OH 43086

FIRING TIPS is a series of firing problem solvers. New TIPS are available every month. Contact your Orton supplier for your copy.



heat up can lead to uneven heating and cracking of the piece. Thermal shocking means that the surface of the glass changes temperature rapidly.

When fusing glass, it is important to control the heating rate between about 150°F and 500°F. For larger or thicker pieces more time is needed. Glass fired in a mold is more susceptible to uneven heating since contacts with the cooler refractory (mold) can lead to uneven heating.

Direct radiant heat from heating elements needs to fall uniformly on the glass or it can cause uneven heating. Most glass firing is done in electric kilns, often with elements above the glass.

### **Glass Annealed Too Quickly**

Annealing is done to reduce stresses in the glass that can result in cracks or breaks. Typically annealing is accomplished by soaking during the cooling cycle (at about 900°F) and then slow cooling between 900°F and 500°F. The amount of time the glass is annealed depends on its thickness. Annealing permits all the glass to equalize in temperature.

When glass is annealed too quickly, stresses can remain that can cause cracking.

When thick sheets or pieces of glass are being annealed, a process called firing down may be necessary. Firing down is done during the slow cooling phase of annealing. Firing down is

used if the kiln is unable to maintain the slow cooling rate required for the piece. The process of firing down involves adding a small amount of heat to the kiln as it cools.

The best way to control cooling during annealing is to use an automatic controller. The desired anneal temperature, soak time and cooling rate are set and the kiln operates automatically. Temperature is displayed. However, even with a controller, the cooling rate set by the operator may be too fast for the kiln to achieve. It is necessary to monitor the temperature change to insure the proper annealing and cooling down occurs.

The thickness of the glass being fired

### **Want to learn more?**

Read more about annealing and firing glass in the Orton Firing Line and Technical Tips publications. Each issue is packed full of articles to help you learn more about firing. Members of the Orton Firing Institute receive these publications at no charge. Single copies are available to non-members at a per issue rate. Orton's 80 minute video, *Key Principles of Successful Firing*, is also an excellent resource on firing.

For information on Orton products, see your Orton dealer or distributor. For information on the Firing Institute, video or publications, contact

Orton Firing Institute, PO Box 2760,  
Westerville OH 43086, 614-895-2663

**Orton pyrometric cones and bars • KilnVent systems  
kiln accessories and firing supplies • Orton Firing Institute**

# Firing Tips

## SUCCESS WITH GOLDS

Gold overglazes are known as liquid precious metals. They are expensive and because of this they are traditionally used only for decoration.

Golds are typically used to add detail or distinction to plates, cups and china blanks.

There are several types of gold available in different forms, including bright golds and burnished golds.

### Bright Golds

These are gold overglazes. They are not solid gold; instead they contain some percentage of gold, usually about 5 to 15%.

They come as a liquid solution and are usually applied with a brush to reduce waste. A thin coat is preferred to prevent the decoration from running, or failing to adhere.

If the liquid gold becomes too thick, it can be thinned with gold essence. Both of these products are very expensive and come in small vials or bottles.

### Burnished Gold

Burnished golds are also gold overglazes. They differ from bright golds in that they require finishing (burnishing) to develop a lustrous finish and bright sheen.

Burnished golds are more durable and have a higher resistance to scratching than other golds. Their appearance is very rich and dense and slightly more matte. The brightness or matte quality can be controlled by application. A thinner application makes for a brighter gold.

Burnished golds contain 16-32% gold, including gold powder. Burnished golds are available in several forms: liquid, paste, dry powder or concentrated pasts. The dry powder is extremely expensive.

There are some burnished golds that do not require polishing. These contain between 12 and 20% gold.

### Firing Golds

Golds generally fire in the 022 to 018

**Orton**

The Edward Orton Jr.  
Ceramic Foundation  
PO Box 2760 • Westerville OH 43086

FIRING TIPS is a series of firing problem solvers. New TIPS are available every month. Contact your Orton supplier for your copy.

cone range. This can vary greatly depending on the gold itself and the ware it is being used on. For typical glassware, an 022-021 firing is the most common. For china blanks, the gold can fire as high as 011. Follow the instructions of the manufacturer when firing golds.

Gold will adhere best with a slow firing and a soak. This helps them to develop the proper color and finish. A faster firing increases the risk of surface defects which can be magnified through washing or use.

Golds contain heavy solvents which make kiln ventilation a must for both health and safety reasons and to bring air into the kiln. Usually gold is fired alone to reduce contamination problems.

### **Typical Gold Faults**

Most gold faults are surface defects. These include:

**cloudy appearance**  
caused by inadequate ventilation or too heavy application, firing too fast or overfiring

**gold not adhering**  
caused by underfiring or too heavy application

**gold is running**  
caused if application is too heavy

**burnished gold is dull**  
caused by insufficient burnishing or possible underfiring

**dull or scummy appearance**  
caused by inadequate ventilation or possible overfiring

**cracking in finish**  
caused by firing too fast

**pinholes and blemishes**  
caused by poor quality of gold or contamination of gold

**blisters**  
caused by heavy application

Application and proper firing are the key to great gold results. Gold should be applied in moderation using a very light coating. Be sure to vent the kiln until it glows red hot. Use witness cones to verify the proper heatwork was achieved.

### **Want to learn more?**

Read more about using golds in the Orton Firing Line and Technical Tips publications. Each issue is packed full of articles to help you learn more about firing. Members of the Orton Firing Institute receive these publications at no charge. Single copies are available to non-members at a per issue rate. Orton's 80 minute video, *Key Principles of Successful Firing*, is also an excellent resource on firing.

For information on Orton products, see your Orton dealer or distributor. For information on the Firing Institute or publications, contact

Orton Firing Institute, PO Box 2760,  
Westerville OH 43086, 614-895-2663.

**Orton pyrometric cones and bars • KilnVent systems  
kiln accessories and firing supplies • Orton Firing Institute**

# Firing Tips

## SUCCESS WITH DECALS

Decals offer an opportunity to add decoration to ceramic and glass ware without the time and skill required for hand painting. When properly applied and fired, decals can add color, texture, design and personalization to a piece.

To achieve professional results with decals, it's important to understand how to select, apply and fire the decals.

- type of decals
  - different decals are made for glass and ceramics
  - ceramic decals often fire hotter than those for glass
- application
  - decals must have good contact with the surface of the ware
  - all wrinkles and bubbles need to be smoothed away
  - avoid tearing the decal
- firing
  - decals are generally low firing - from cone 022 to 016
  - check the package for the proper firing range
- venting
  - decals contain lots of organics which need to be burned off

often smelly fumes result during decal firings

### Firing Decals

A decal isn't fired that much differently than any other piece of ware, although there are some special considerations.

1. Venting is very important to good results with decals - especially to get true colors.

Problems related to venting include:

- poor color development
- a cloudy or hazy appearance

2. Proper heatwork is also an important factor. Decals that are under or overfired may exhibit the following:

- faded colors (overfired)
- color shift (underfired)
- decals rub off (underfired)
- dull appearing metallics (underfired)

### Determining Firing Range

Because the colors on decals can so easily be affected by the amount of heatwork they receive, we recommend test firings to determine the best firing range.

**Orton**

The Edward Orton II Ceramic Foundation  
6901 Old 30 Highway  
Westonville, OH 43082

FIRING TIPS is a series of firing problem solvers. New TIPS are available every month. Contact your Orton supplier for your copy.

Use a series of witness cones to fire samples of the decals on tiles or blanks. Make several firings and then select the fired appearance which looks the best.

### **Color development**

Cloudy looking decals or decals where the color is not bright need to have additional air to develop properly. Organics need to be burned out and carbon monoxide fumes have to be removed from the kiln.

Manual venting by propping the lid and removal of peephole plugs will improve the firing, but may not help bring enough air to the bottom of the kiln or to distribute it evenly throughout the load.

A downdraft vent system will ensure sufficient air is brought into the kiln and circulated throughout.

### **Measuring heatwork**

Heatwork is another critical factor in the color development of decals.

Fading, shifting and dullness are signs of too much or too little heatwork. This is also true when decals rub off after firing. (White or blank spots or burned off areas are generally related to application, not firing.)

Use witness cones to measure heatwork and to check the heat distribution in the kiln. Firing to a temperature or firing to a Kiln-Sitter® cone may not give the same results as found with a witness cone next to the ware.

### **Measuring heat distribution**

Differences in heat distribution from top to bottom in the kiln are usually far more noticeable for cooler firings like decals. A 2 or 3 cone difference at 022 may only be a 1 cone difference at cone 6. This is because at higher temperatures radiation heats the kiln more effectively.

Slowing the first half of the firing can help heat distribution problems. This also helps by allowing more time for air to enter the kiln and burn out organics and for carbon monoxide to leave the kiln.

Use a controller to set heating rates and soaks for more precise firings.

### **Want to learn more?**

Read more about successfully firing decals in the Orton Firing Line and Technical Tips publications. Published 8 times a year, each issue is packed full of articles to help you learn more about firing. Members of the Orton Firing Institute receive these publications at no charge. Single copies are available to non-members at a per issue rate.

For information on Orton products, see your Orton dealer or distributor.

For information on the Firing Institute or publications, contact

Orton Firing Institute, 6991 old 3C Hwy., Westerville OH 43082, 614-895-2663.

# Firing Tips

## MAKING FOODSAFE WARE

When making ware to contain food and beverages, it is very important to be sure it is foodsafe. Some of important considerations for mugs, serving pieces and dinnerware include:

- body composition
- design of the ware
- glaze selection
- decoration
- firing to maturity
- testing for lead safety
- government regulations

### What Type of Ware?

The design of some pieces of ware have inherent problems which make them unsuitable to contain food and beverages.

Design-related cracks, rough areas, crevices and nooks and crannies are difficult to clean and might trap bacteria. They can also be difficult to thoroughly glaze. Pitchers with hollow handles can have the same problems.

Ware also needs to be serviceable - that is, it should be strong so it won't fail or break during service.

### Making Smart Glaze Choices

While glazes are extremely durable, most are not completely insoluble. If attacked by acids in foods such as orange juice, vinegar and tomatoes, small amounts of the glaze may dissolve and pose a health hazard.

Acid resistant glazes have passed rigorous tests and are labeled as foodsafe. These should be selected for glazing food ware. Lead-free glazes may not be acid-resistant and should not be used unless labeled as foodsafe.

Homemade, altered, crackle, matte or specialty glazes also should be avoided for surfaces of containers that will contact food and beverages.

### How to Decorate

When glazing, be sure to completely glaze the ware to ensure the entire body is sealed. Properly bisqued porcelain may be dry footed, but only if the porcelain has been fired to vitrification. Label the ware as foodsafe for future users.

China paints, decals and rim designs

Orton

The Edward Orton Jr.  
Ceramic Foundation  
PO Box 2760 • Westerville OH 43086

FIRING TIPS is a series of firing problem solvers. New TIPS are available every month. Contact your Orton supplier for your copy.

are a popular way to decorate plates and mugs, but may not be safe for food surfaces. Specific regulations exist for the location of rim decorations which must be followed.

Decals should be used on the outside of a piece where they will not be in contact with food or beverages. Use china paints on decorative items only.

### **Safe Firing**

Proper glaze firing and the bisque firing are very important to insure ware is foodsafe. If the bisque is underfired, it may create problems with glaze and body fit that result in crazing of the glaze, or glaze surface defects such as pinholes. These would not be acceptable for ware used to contain food and beverages.

If the glaze is not properly matured, it will not meet the foodsafe standards under which it was tested and may craze while in service.

Using pyrometric witness cones on the kiln shelf is the only way to insure that a proper firing has occurred. For foodsafe ware, many prefer to fire their bisque to an 03 witness cone just to be sure it is fully mature. Read and follow the manufacturer's instructions for glazes for the best and safest results.

### **Regulations**

There are several very specific regulations for ware which will contain or contact food and beverages. California has the most stringent rules for dinnerware and new standards have been set

by the FDA for rim decorations. These rules are available from state and federal agencies. If you are selling your dinnerware you may be subject to additional regulation.

### **How to Test for Lead Release**

Several easy to use products are available on the market to test for lead release. These are primarily quantitative tests - that is, they tell you yes or no if the surface has lead above a certain level. The most commonly used kit is a thick cotton swab which turns pink if lead levels are exceeded. This test does not harm ware so if it tests too high in lead, the piece can still be used as decoration. These tests are a simple, economical way to feel confident that your ware is safe.

### **Want to learn more?**

Read more about Making Foodsafe Ware in the Orton Firing Line and Technical Tips publications. Each issue is packed full of articles to help you learn more about firing. Members of the Orton Firing Institute receive these publications at no charge. Single copies are available to non-members at a per issue rate. Orton's 80 minute video, *Key Principles of Successful Firing*, is also an excellent resource on firing.

For information on Orton products, see your Orton dealer or distributor. For information on the Firing Institute or publications, contact

Orton Firing Institute, PO Box 2760,  
Westerville OH 43086, 614-895-2663.

**Orton pyrometric cones and bars • KilnVent systems  
kiln accessories and firing supplies • Orton Firing Institute**







*The Cone 10 High Fire  
40 Litre (1.4 cu ft) kiln that  
plugs into a 230 volt 13 amp  
home circuit*



**ASSEMBLY & WIRING  
DIAGRAMS**

**Fuego!**

# ASSEMBLING YOUR L&L EASY-FIRE KILN (EUROPEAN VERSION)

## **TOOLS NEED FOR THE JOB**

You will need the following tools for the job:

- 1) Philip's head screw driver (medium size head)
- 2) Knife
- 3) Needle Nose pliers
- 4) Adjustable Wrench
- 5) Level
- 6) Safety Goggles
- 7) Special Spring Hinge Tool (provided)

### **CAN YOU MOVE THE KILN WITHOUT DISASSEMBLING IT?**

The kiln is shipped mostly assembled (except for the stand and the disengaged hinge spring). It is possible to move the kiln without disassembling it. However, these kilns, particularly the e28S-eu and e28T-eu, are very heavy and awkward to move. If you decide to move it without disassembling the sections first be absolutely certain you have at least two or three strong people who are familiar with proper lifting techniques. Serious back injury could result if such a heavy object is lifted improperly. See page 4 for details on how to do it - there are specific instructions depending on which model you have.

## **UNPACKING**

### **Inspect for visible damage**

The carton should arrive without visible damage. If the carton was damaged in transit, you should either refuse shipment or unpack the kiln in the drivers presence in order to file a damage report with the freight company. **Call your distributor immediately if there is a problem. SAVE ALL MATERIALS UNTIL YOU ARE SURE YOU WON'T NEED THEM. AT THE VERY LEAST NOTE DAMAGE ON THE BILL- OF-LADING - WITHOUT THIS YOU HAVE NO PROTECTION!**

*Below is a picture of how your kiln should arrive:*

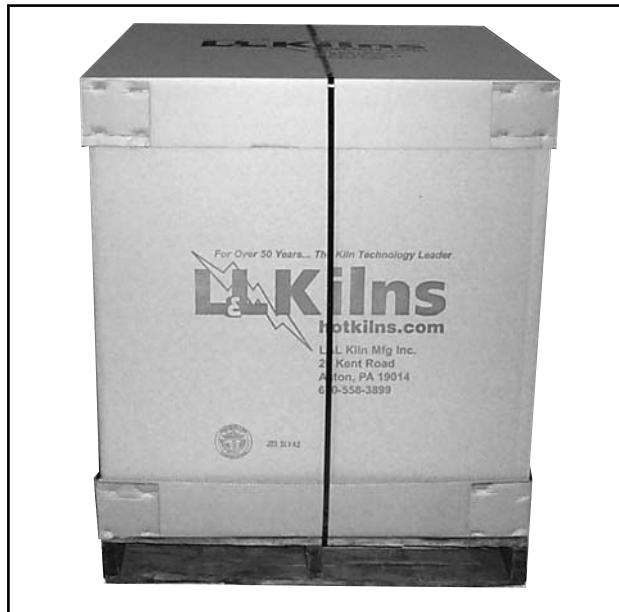

### **Unpacking the kiln**

- 1) With a screw driver pry off the staples holding the bottom box tray to the box sleeve.
- 2) Next remove the cardboard inset from the carton, and remove the carton sleeve from the skid.
- 3) Cut the banding around the kiln box and remove the top.
- 4) You are looking at the heavy duty top of the kiln stand. Remove it and set it off to the side.
- 5) For all kilns you will find the following items:
  - a) spring hinge tool (e23S-eu, e23T-eu, e28S-eu, e28T-eu only)
  - b) instruction manual with Training Video/CD
  - c) stand legs with the mounting hardware

# ASSEMBLING YOUR L&L EASY-FIRE KILN (EUROPEAN VERSION)

Remove the box sleeve from over the kiln:



3) Push the foam tubes away from the kiln.

**Removing foam tubes:**



4) Carefully cut off the stretch wrap that is around the kiln. Be careful not to scratch the kiln with your knife.

Carefully cut off shrink wrap:



4) If you ordered a three section kiln, either the (e18T-eu, e23T-eu, or e28T-eu) your kiln floor will be on top, remove it now. If you ordered a two-section kiln, the floor of the kiln will not be on the top, it will be on the bottom of the kiln as it is part of the spring hinge mechanism which is assembled but not engaged for shipping.

5) Notice that the spring on your spring hinge is not engaged.

## **ASSEMBLING THE STAND**

Next, using the stand hardware and vent system hardware, assemble the vent system bypass collection box to the kiln stand. Then the flexible duct to the bypass collection box

1) Assembly the stand legs. **Make sure all the stand legs are tight.** Use a nut driver or an adjustable wrench to do this.

# ASSEMBLING YOUR L&L EASY-FIRE KILN (EUROPEAN VERSION)

The legs get bolted to the stand with 1/4-20 bolts provided. They do not need nuts:

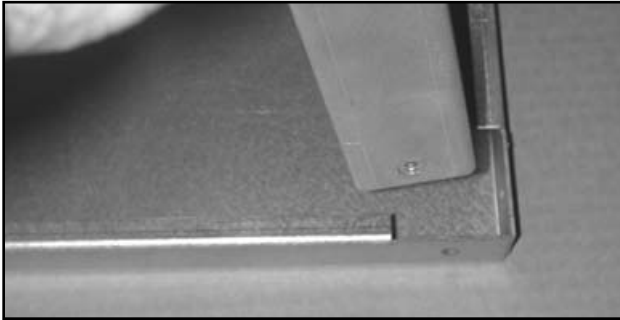

The fully assembled stand:

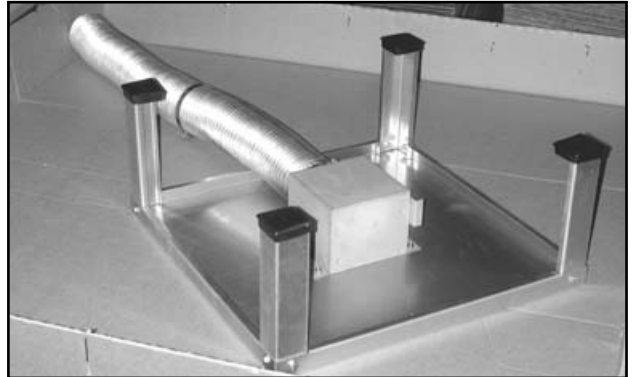

## IF YOU HAVE A VENT-SURE VENT

The vent collection box fits over four studs on the bottom of the stand and gets fastened on with four 10-24 nuts :



3) Attach the flexible vent tube to the outlet of the vent collection box. This takes some patience to get the flexible tube around the fitting.

**Installing the flexible duct onto the Bypass Collection Box of the Vent-Sure Vent System:**

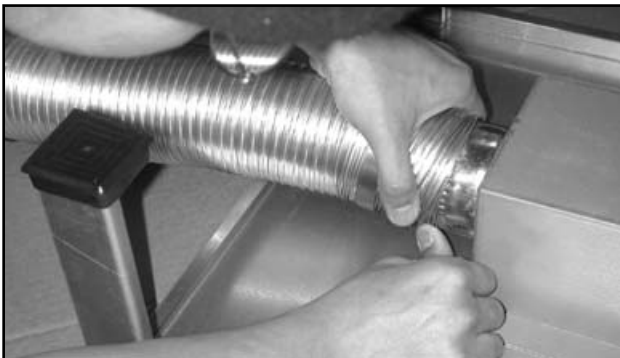

4) Fit the rubber-plastic feet over the bottom of the legs. The stand is now fully assembled.

## REMOVING THE LID

The next step is to remove the lid from the kiln. Remove the cotter pin, then the hinge pin, pull the bar out and remove the spring. Set them aside. Remove the lid from the kiln.

*The hinge is shipped assembled (without the spring engaged). This way you can see how it all goes back together.*

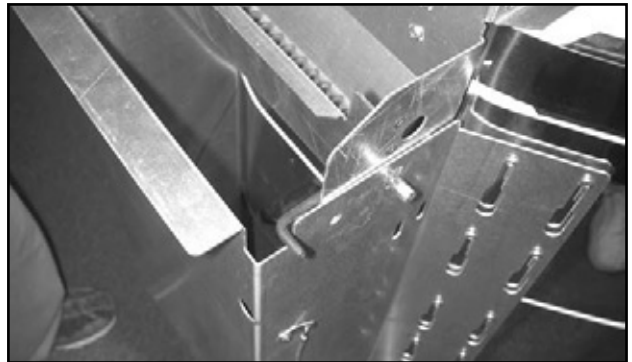

Now you can remove the top :

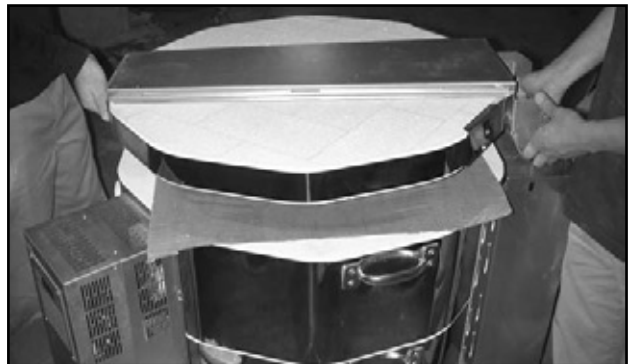

# ASSEMBLING YOUR L&L EASY-FIRE KILN (EUROPEAN VERSION)

## MOVING THE KILN WITHOUT DISASSEMBLING IT

SEE THE CAUTION NOTE ON PAGE 1 OF THESE INSTRUCTIONS. THIS TAKES TWO OR THREE STRONG PEOPLE TO DO.

### Moving an e18T-eu, e23T-eu or e28T (three-section kiln):

- 1) Remove the lid because this is easy and removes much of the weight.
- 2) Prepare the stand and place the floor slab on the stand.
- 3) Pick the the kiln up by the chest handles on the bottom kiln section and place the three connected sections on the floor slab.

### Moving an e18S-eu, e23S-eu or e28S-eu (two-section kiln):

- 1) Remove the lid because this is easy and removes much of the weight.
- 2) Prepare the stand.
- 3) Pick up the kiln by the front chest handle attached to the kiln floor and by the hinge.

**NOTE: It is important to lift the two-section kilns up by the handle on the floor slab because the hinge is attached to the floor slab in the back of the kiln. You will damage the floor slab if you do not follow this procedure.**

- 4) Place the entire unit on the prepared kiln stand. Go to “Locating the Kiln” on page 8.

## REMOVING THE HINGE

- 1) Loosen the screws of the large hinge piece that holds the three rings together (or the two rings and bottom).

**DO NOT REMOVE SCREWS.** The keyhole slots will allow you to remove the hinge piece without taking the screws out. If you take the screws out it increases the chance of stripping a screw. Even though there are plenty of screws to take the load it is best to avoid stripping them.

- 2) Gently pull the ring hinge piece up and away from the kiln

***Pulling the hinge piece up and away from the kiln. It should slide up easily. If not check all the screws because it only takes one screw that is not loose enough to prevent the hinge piece from sliding up:***



# ASSEMBLING YOUR L&L EASY-FIRE KILN (EUROPEAN VERSION)

## REMOVING THE CONTROL PANEL AND ELEMENT COVER AS ONE ASSEMBLY

You have two choices. You can remove the Control Box and Element Cover Box as ONE assembly or you can first remove the Control Box from the Element Cover Box and then remove the Element Cover Box. The easiest method, in our opinion, is to remove the whole assembly. However, both methods are given.

1) Remove the two screws, that hold the outer portion of the control panel to the element terminal box.

*Removing the two screws that hold the control panel on:*

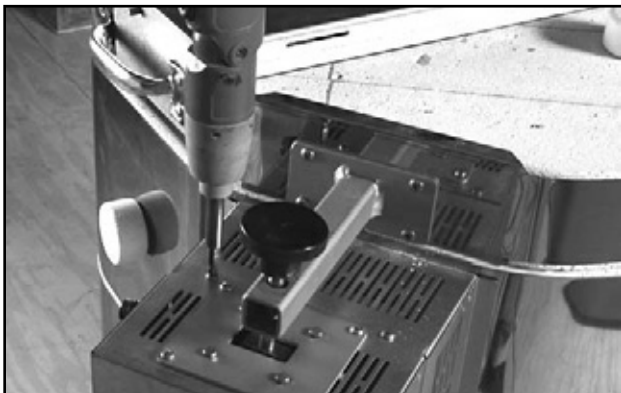

2) Hinge the dynatrol portion of the control panel down exposing the wire connection terminals.

*The Control Panel Hinged down:*

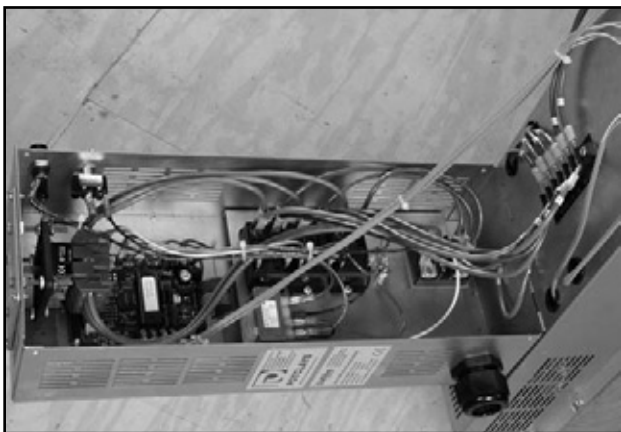

3) Remove the wires numbered 1 through 6 from the left side of the Power Terminal Strip and the right side of Thermocouple Terminal Strip.

*Wires shown removed:*

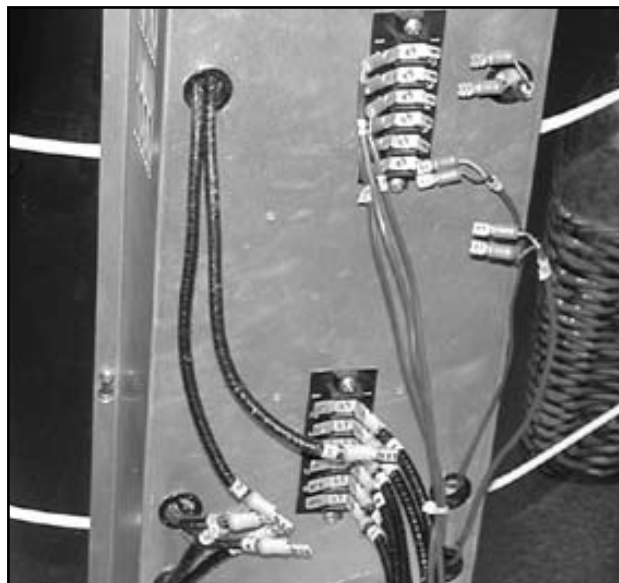

4) Loosen - but do not remove - the four or six screws that hold the Element Cover Box to the kiln.

*The keyhole slots on the Element Cover Box will allow you to remove it without having to take the screws out:*



5) Hold the whole assembly and gently lift up so that the large part of the tear-drop holes allows the head of



# ASSEMBLING YOUR L&L EASY-FIRE KILN (EUROPEAN VERSION)

the four of six screws to pass through. This will take a little juggling but it will come off.

*He is holding the box from underneath:*



*Pushing the wires through the holes:*



6) Now skip to the the section called “LOCATING THE KILN”.

## REMOVING THE CONTROL PANEL AND ELEMENT COVER AS TWO ASSEMBLIES

This is method number two.

### REMOVING THE CONTROL PANEL

1) Remove the two screws, that hold the outer portion of the control panel to the element terminal box.

*Removing the two screws that hold the control panel on:*



2) Hinge the Dynatrol portion of the control panel down exposing the wire connection terminals.

*The Control Panel Hinged down:*

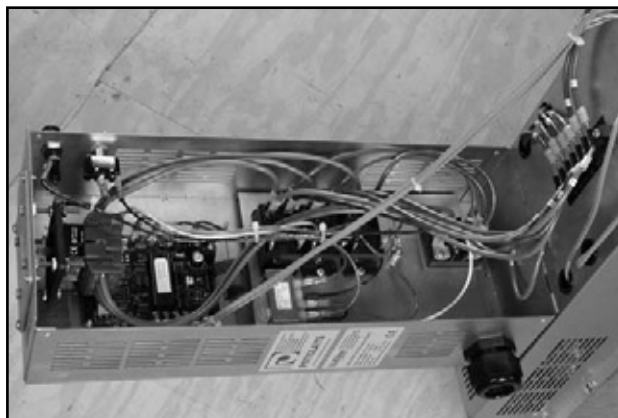

3) Remove the wires numbered 1 through 6 from both sides of the Power Terminal Strip.

# ASSEMBLING YOUR L&L EASY-FIRE KILN (EUROPEAN VERSION)

*Power Terminal Strip is shown :*

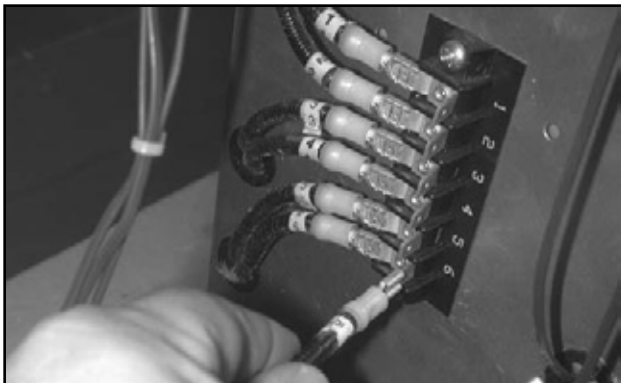

4) Remove wires numbers 1 through 6 from both sides of the Thermocouple Terminal Strip.

*The Thermocouple Terminal Strip:*



5) Remove the green ground that connects the front panel to the rear panel.

*Removing the ground wire:*

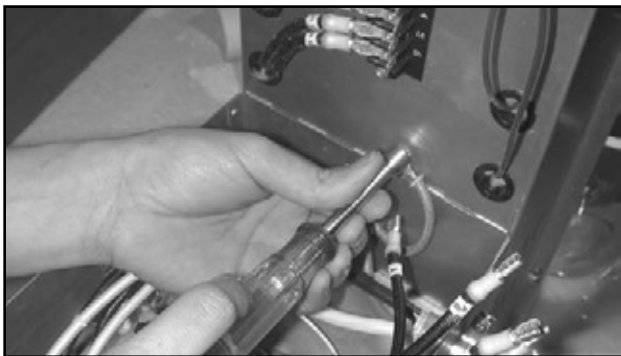

6) Tilt the control panel halfway back to its original position and gently pull the panel from the element box and set aside. It will take a combination of pulling slightly up and slightly out to disengage the control panel from the element terminal box.

*Removing the panel:*

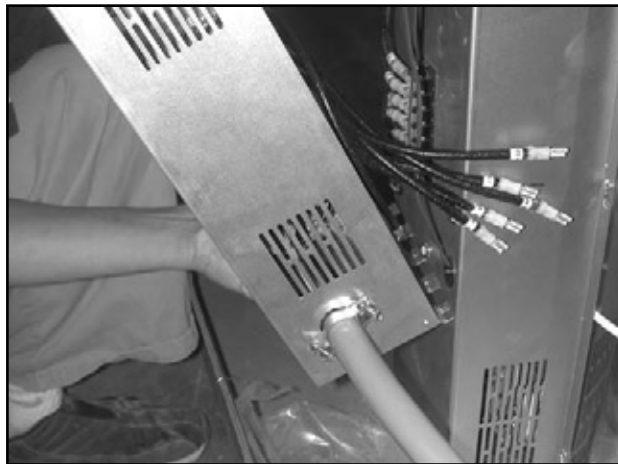

## REMOVING ELEMENT COVER BOX

If you prefer you can remove the box using the method shown on page instead.

1) Remove the three screws on the right hand side of the element box and set them aside.

*Removing the right hand screws :*



2) Loosen the 3 screws on the left hand side of the element box but leave them in place. Loosen them to about a 12mm (½ inch).



# ASSEMBLING YOUR L&L EASY-FIRE KILN (EUROPEAN VERSION)

*Loosen the left hand side :*



3) Gently push the right hand side of the element box away from the kiln sections. This will give you access to pull the element and thermocouple connection wires through the element box.

*The Element Terminal Box swings over to the left side exposing the wires :*



4) Pull the power and thermocouple wires out.

*Pulling the wires out from the back of the terminal box:*

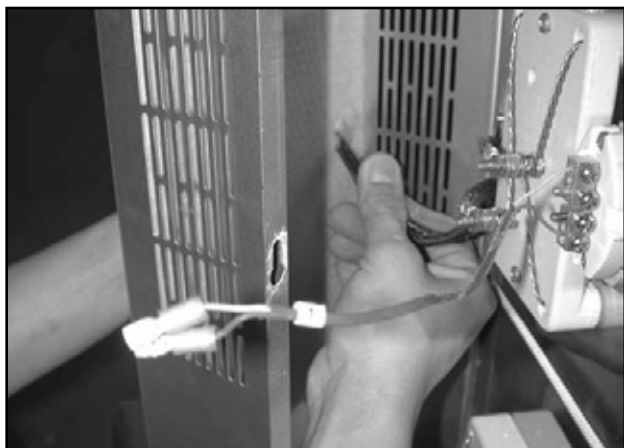

5) Gently lift the element box up and remove from the kiln sections.

*Removing the Terminal Box form the kiln:*

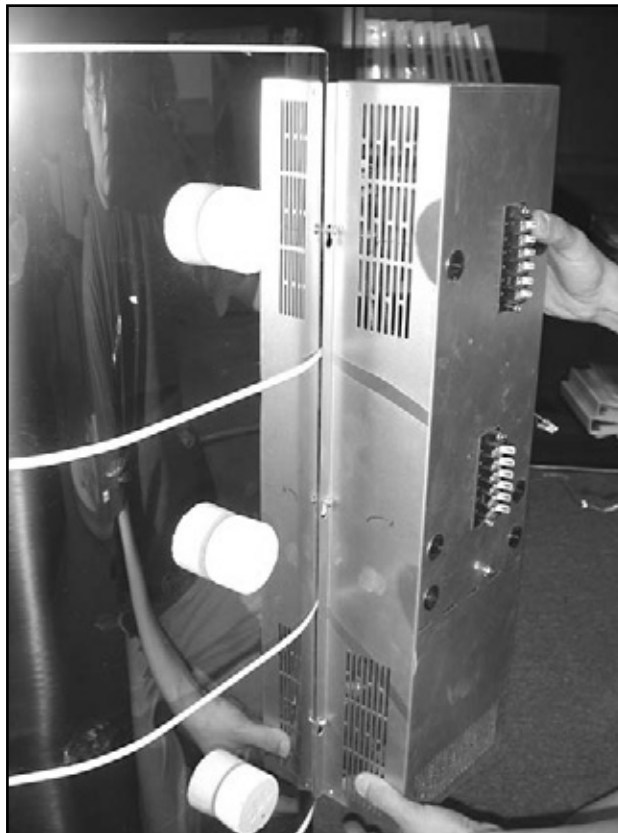

6) You are now ready to set up the kiln.

## **LOCATING THE KILN**

1) Place the stand on the floor in the desired location. This should be set so that the outside stainless steel surface of the kiln will be at least 30cm (12") to 45cm (18") from any combustible wall. Floor must be nonflammable.

Information concerning clearances, ventilation and electrical requirements is detailed in the INSTALLATION Section of this manual. Read now if you are uncertain about any of these issues. **DON'T PROCEED UNTIL YOU ARE COMFORTABLE WITH THE LOCATION THAT YOU SELECT.** You don't want to do this job twice.

2) Place bottom floor section of kiln on the steel stand making certain it is centered properly.

3) Note that the kiln bottom is packed on top of the kiln - so it is easily removed first without moving the kiln.

# ASSEMBLING YOUR L&L EASY-FIRE KILN (EUROPEAN VERSION)

## SETTING UP THE KILN

1) Place the stand in your desired location making sure to face the flexible duct work toward the wall that the kiln will be vented through.

**Level the stand. Use metal shims under the legs to accomplish the leveling. Make sure that the base will not wobble.**



2) You're now going to build the kiln from the bottom up.

3) Place the bottom of the kiln on the kiln stand, make sure the holes for the vent line up with the large 3" hole on the kiln stand. Center the bottom brick on the stand. It is not critical how the polygonal brick is oriented to the square stand.

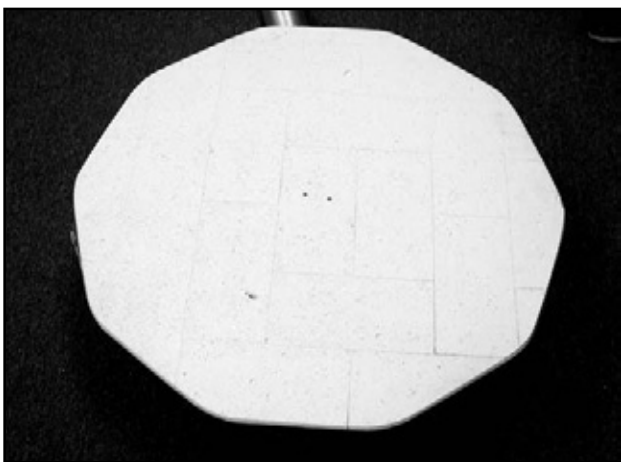

4) **LEVEL THE KILN NOW!** Do this before proceeding because at this point it is easy to put a level on the flat bottom. Use metal shims under the legs to accomplish the leveling. We suggest using a carpenter's level for this job. Make sure that the base will not wobble.

## WHY IS LEVELING SO IMPORTANT?

If the stand and the bottom are not level your kiln batts will not be level and loading will be difficult. Kiln batts loaded with ceramic ware are like a house of cards to begin with - don't make it any harder!

Also - an uneven floor will quickly become a cracked floor. There should be equal support under each leg of the stand so the floor does not rock back and forth.

Be patient about doing this right as you are assembling the kiln. Once you have put the kiln sections on the bottom of the kiln you will not want to take it off - so it is important to have this base be level to start with.

5) Place the kiln section with the #5 & #6 on the thermocouple wire on top of the kiln stand (this will not exist for an e18S-eu, e23S-eu or e28S-eu so skip to the next step if you have one of those kilns).



# ASSEMBLING YOUR L&L EASY-FIRE KILN (EUROPEAN VERSION)

6) Place the kiln section with the #4 & #3 on the thermocouple lead wire on next.



7) Place the kiln section with the #1 & #2 on the TC wire on the top ring of the stack.



8) You are now ready to reattach the hinge.

## SETTING UP THE SPRING HINGE

### FOR AN E18S-EU & E18T-EU WITH NO SPRING HINGE

(There is no spring hinge for the e18S-eu or e18T-eu. If you want to remove the lid on those models, just pull off one of the cotter pins holding the hinge bar in place, pull out the hinge bar, and remove the screws that hold the chain on to the lid.

1) Notice that on the back of the kiln that the mounting screws for the hinge line up.

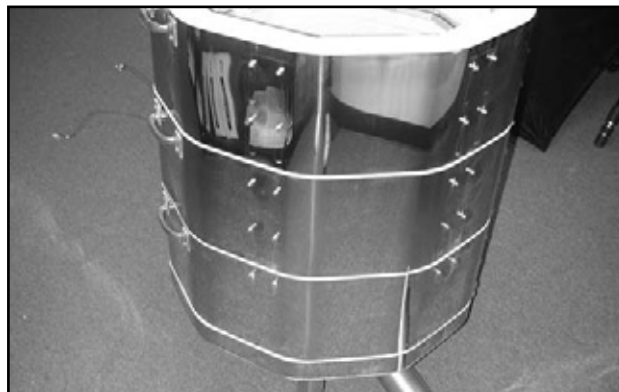

2) Take the large ring hinge piece and drop it onto the screws on the kiln sections. If the screws on the kiln don't perfectly line up with the holes in the large hinge piece gently maneuver the hinge piece until you have all the screw heads into the keyhole slots on the large hinge piece. **Let the piece drop to the top of the slot and rest but do not tighten the screws at this time.**



# ASSEMBLING YOUR L&L EASY-FIRE KILN (EUROPEAN VERSION)

3) Place the kiln door with the hinge top hinge piece attached inside the large hinge piece on top of the kiln.



4) Get together your spring, hinge rod, hinge cotter pins and hinge spring tool (that is the long 1/2" diameter metal rod with the machined slot in the end).

5) Next you are going to take the spring and put it inside the lid hinge piece making sure that the short end of the spring is in the hole to the left of the hinge piece as you are looking at it.

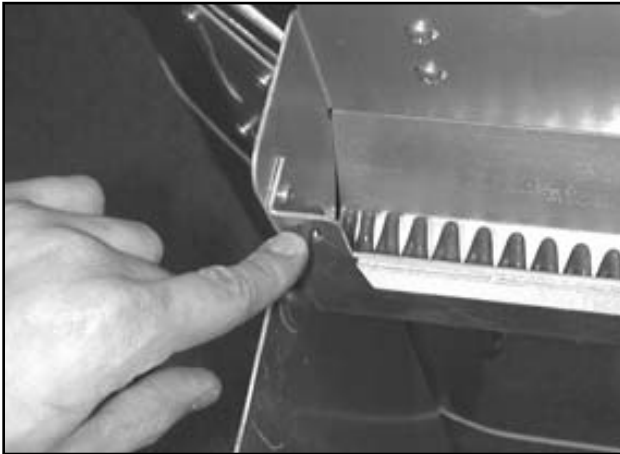

6) Place the hinge bar through the large hinge piece, through the spring and out the other end of the large hinge piece. Insert the cotter pins into the holes in each end of the hinge bar.



It is critical that the hinge bar sits in the bottom of the slot. This allows the lid to raise and lower as the kiln body expands with the heat. Otherwise the kiln lid could be damaged during firing.

8) Raise the large ring hinge piece up until the hinge bar sits in the **bottom of the slot**. While holding the large ring hinge piece in place tighten the screws.

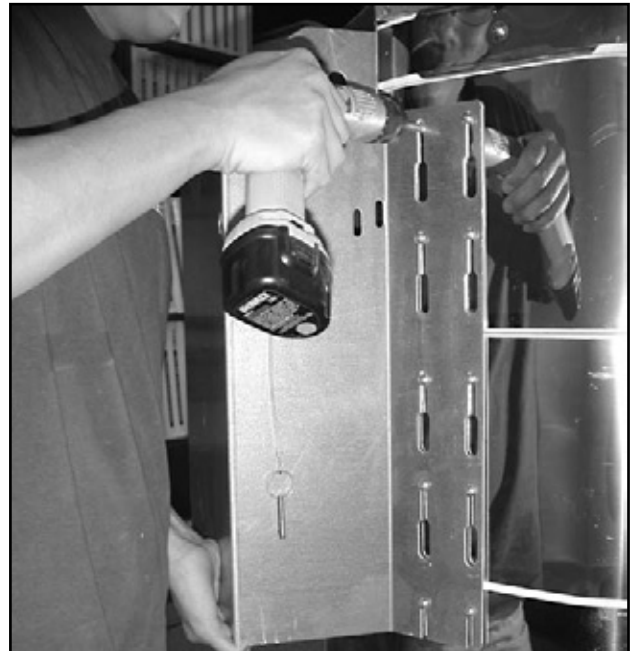

## ASSEMBLING YOUR L&L EASY-FIRE KILN (EUROPEAN VERSION)

**CAUTION:** There is a great deal of tension created by the torsion spring. Use extreme caution when installing it. **Wear safety goggles.** Use the special tool provided as directed. The use of a tool that does not grab the end of the spring to allow you to control it may result in serious bodily injury. Call L&L if you do not have this tool. We will provide it at cost for an old kiln.

9) Next you are going to attach the other end of the spring in through the slot on the right hand side of the ring hinge piece (on the right side as you stand behind the kiln). This will require two people. Have one person raise the lid into the upright position and hold it there while the second person places the slotted end of the spring tool through the top of the large hinge piece and onto the spring.



10) Push the spring down as far as you can.

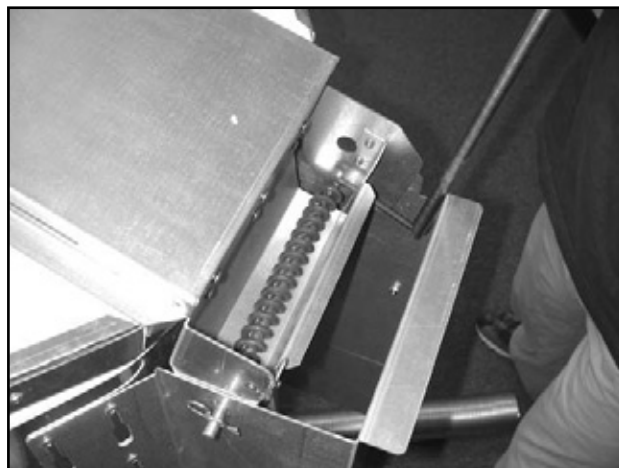

11) Continue to hold the lid upright.

12) Insert the hinge tool down into the body of the hinge as shown and grab the spring with the notched end. Using the hinge bar as a fulcrum push the end of the spring into the first slot.

***Put the hinge tool into the body of the hinge:***



***Top view:***



# ASSEMBLING YOUR L&L EASY-FIRE KILN (EUROPEAN VERSION)

*You can also push the spring into place from the back through the provided hole if you have room to work behind the kiln.*



13) Push the spring into one of the two slotted holes on the side of the large hinge piece. The slot closest to the kiln will put more tension on the spring. (Note - it is hard to get the spring into this slot when working from above).



*Below is a view from the top looking down into the hinge box. NOTE: When removing the hinge - use the reverse procedure and be sure to use the special tool provided.*

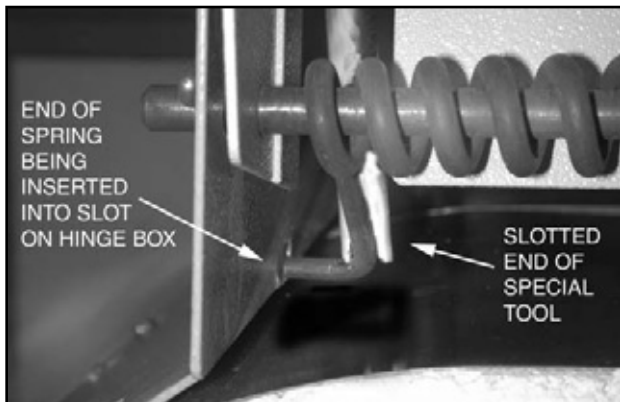

13) The hinge is now operational.

14) Raise and lower the hinge a few times.

15) Double check to make sure that each end of the spring is through the appropriate hole in the ring hinge piece.

16) Open the lid to the full open position and insert the safety pin to keep the lid locked in the up position.



17) You are now ready to reassemble the panel onto the kiln.

# ASSEMBLING YOUR L&L EASY-FIRE KILN (EUROPEAN VERSION)

## REASSEMBLING THE CONTROL PANEL

- 1) Take the Control Box and Element Cover Box Assembly and place it on the screws on the **left** hand side of the element connection terminals (facing from the front).
- 2) Push the whole assembly off to the side left side slightly so you can access the wires and push them through the holes.



- 3) Push the Element Cover Box up against the kiln and position it over the screws through the large part of the tear-drop holes. Tighten the screws.
- 4) Attach all the wires to their proper place on the terminal boards.

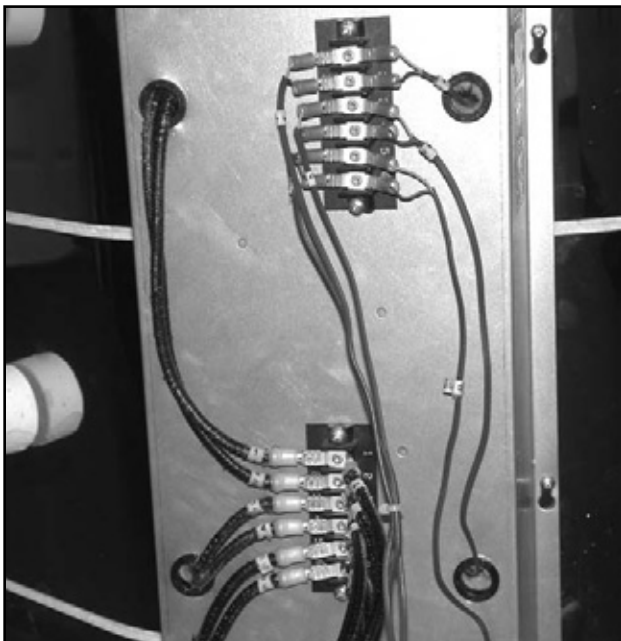

- 5) Close the Control box and screw in the two screws that hold it in place at the top of the Element Cover Box.

### If you removed the panel separate from the element cover box

- 1) Take the element terminal box and place it on the screws on the **left** hand side of the element connection terminals (facing from the front).
- 2) Gently push the right side of the element cover box open enough to allow access to feed the element and thermocouple connection wires through the same holes that you previously removed them from.
- 3) Take the 3 screws that you removed from the right side of the element cover box and replace and tighten them.

Below:



- 4) Next tighten the 3 screws on the left hand side of the element cover box.
- 5) Reconnect the wires to the appropriate numbered terminals.



# ASSEMBLING YOUR L&L EASY-FIRE KILN (EUROPEAN VERSION)

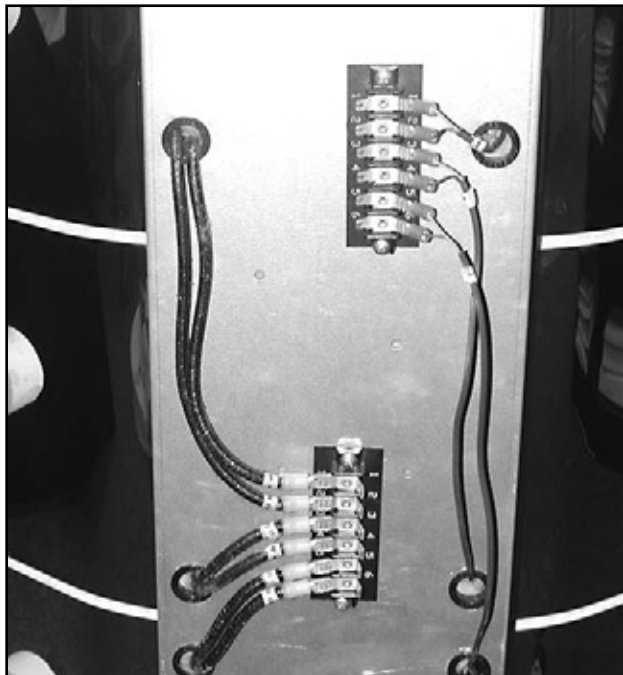

6) You are now ready to reattach the hinge portion of the dynatrol panel.



## **REATTACHING CONTROL BOX**

- 1) Place the tabs on the control panel box back in to the appropriate slots on the element cover box.
- 2) Reattach the ground wire to the ground lug from the control box to the element cover box.
- 3) Reattach all power wires to the appropriate numbered terminals.
- 4) Reattach the thermocouple wires to the appropriate numbered terminals making sure yellow goes with yellow and red goes to red. Make sure to push the slip on terminals all the way onto the tabs on the connection terminals.
- 5) Raise the panel and replace the two screws at the top and tighten making sure to keep the thermocouple lead wires and the power connect wires from getting pinched in the panel.
- 6) Your kiln is now fully assembled and ready to operate.





**NOTES:**

Control Wire:  
16 AWG, 105°C  
Power Wire:  
10 AWG, 150°C

Industrial & commercial applications may require the installation of a **LOCKOUT/TAGOUT** device to prevent the Kiln from operating during maintenance.

This Kiln is recommended to be wired & connected to an approved U. L. & NEC configured receptacle controlled with a disconnect switch and properly fused according to the KW load load specification listed on the Kiln Nameplate. L&L Kiln Mfg., Inc., also recommends fuses rather than circuit breakers to prevent nuisance tripping.

**Model**  
**E18S-EU-230**

|                       |                 |      |    |
|-----------------------|-----------------|------|----|
| VOLTAGE               | 230 / 1 / 50-60 |      |    |
| WATTS                 | ~ 5860          |      |    |
| FULL LOAD AMPS        | L1              | L2   | L3 |
|                       | 26.7            | 26.7 | 1  |
| POWER SUPPLY          | 30A 10 AWG      |      |    |
| ELEMENTS (E-E-18S/41) | QTY             | OHMS |    |
|                       | 4               | 7.9  |    |

L1 ○  
N ○  
G ○

**SAFETY SWITCH BY CUSTOMER**

Connect to  
230 Volt / Single Phase  
50 or 60 Cycles.

**LOOKING INSIDE CONTROL PANEL**

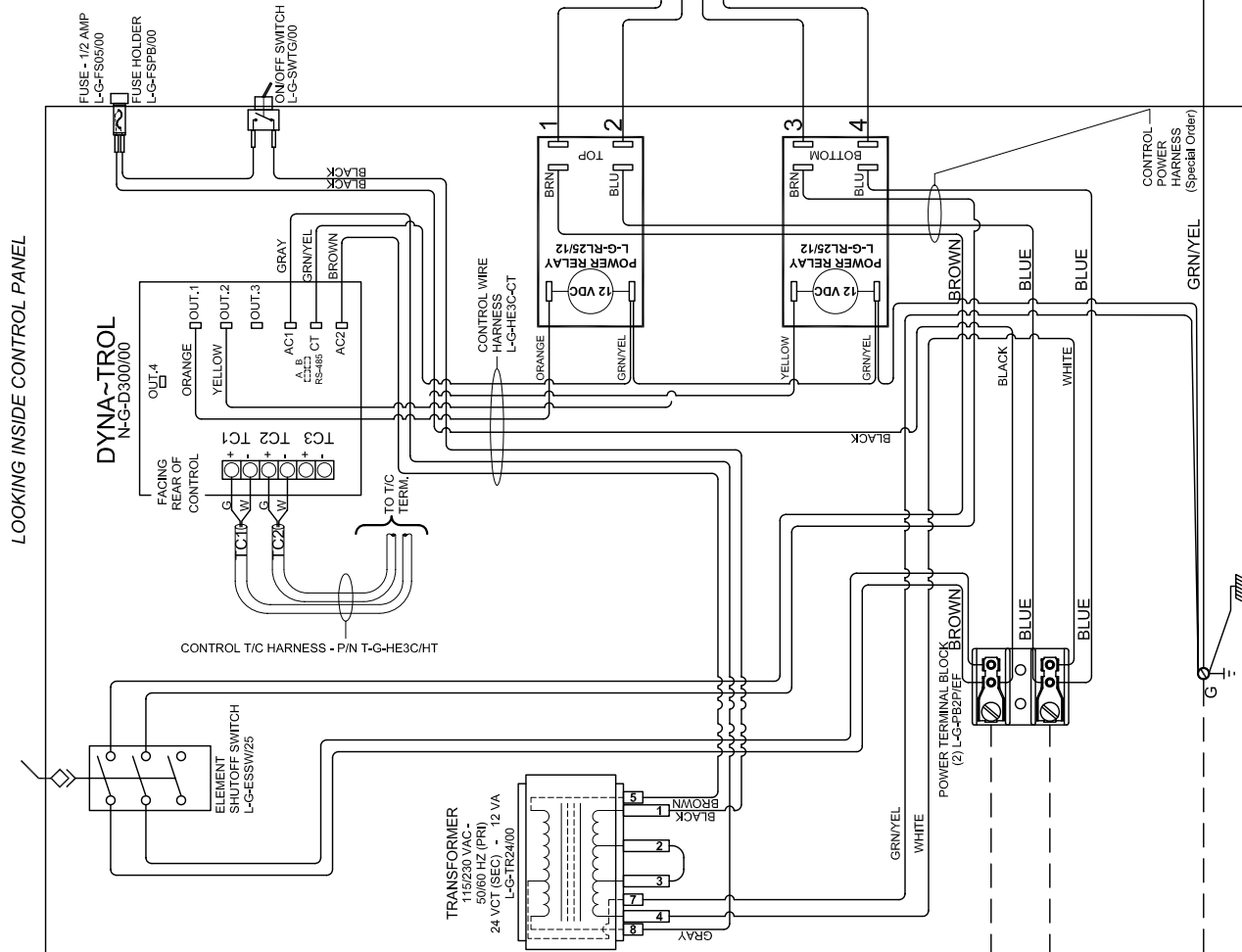

**LOOKING AT OUTSIDE OF ELEMENT COVER PANEL**

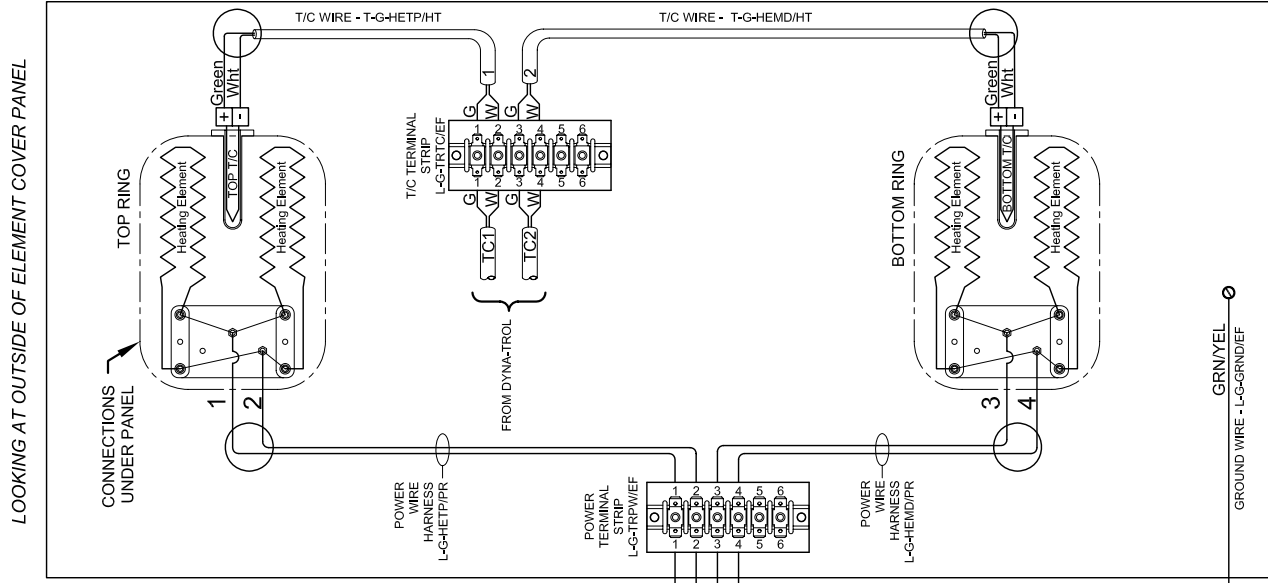

**NOTES:**

Control Wire:  
16 AWG, 105°C  
Power Wire:  
10 AWG, 150°C

Industrial & commercial applications may require the installation of a LOCKOUT/TAGOUT device to prevent the Kiln from operating during maintenance.

This Kiln is recommended to be wired & connected to an approved U. L. & NEC configured receptacle controlled with a disconnect switch and properly fused according to the KW load load specification listed on the Kiln Nameplate. L&L Kiln Mfg., Inc., also recommends fuses rather than circuit breakers to prevent nuisance tripping.

| Model                 |                             |
|-----------------------|-----------------------------|
| <b>E18T-EU-230</b>    |                             |
| VOLTAGE               | 230 / 1 / 50-60             |
| WATTS                 | ~ 8800                      |
| FULL LOAD AMPS        | L1   L2   L3<br>39.9   39.9 |
| POWER SUPPLY          | FUSE   WIRE<br>50A   10 AWG |
| ELEMENTS (E-E-18S/41) | QTY   OHMS<br>6   7.9       |



**SAFETY SWITCH BY CUSTOMER**  
Connect to  
230 Volt / Single Phase Wye  
50 or 60 Cycles.

**LOOKING INSIDE CONTROL PANEL**

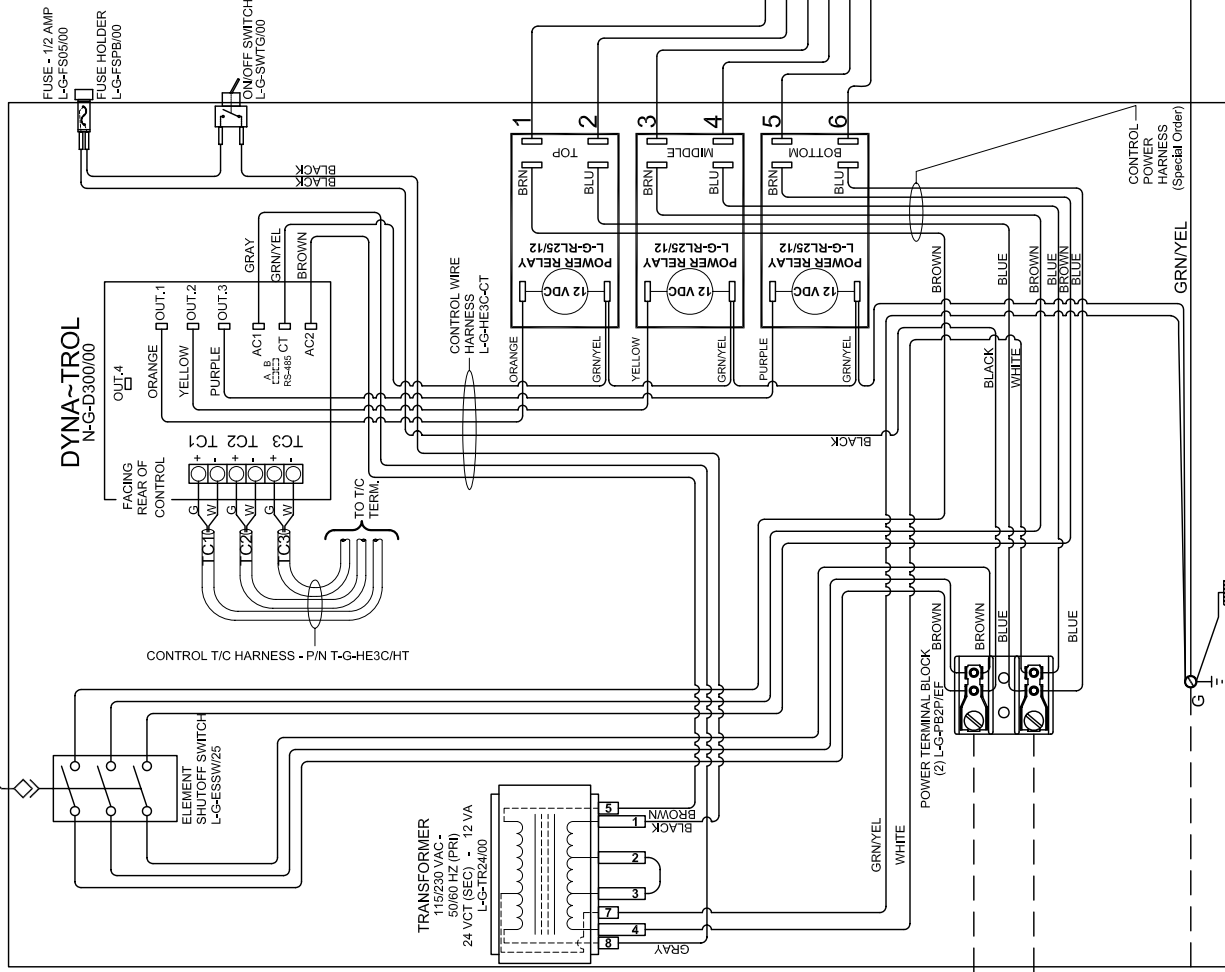

**LOOKING AT OUTSIDE OF ELEMENT COVER PANEL**

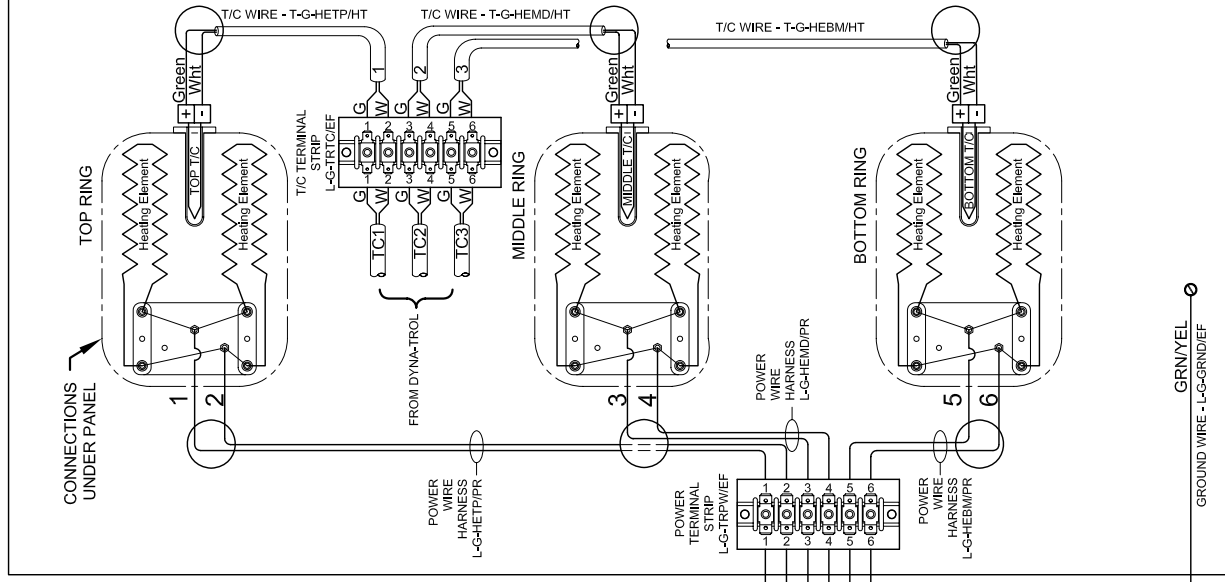

|  |              |              |     |   |
|--|--------------|--------------|-----|---|
| DRAWING NO.  | K282-154 1/1 | SHEET OF     | REV | 0 |
| 8 CREEK PARKWAY<br>PO BOX 1898<br>BOOTHWYN, PA 19061 |              |              |     |   |
| <b>L&amp;L Kilns</b>                                 |              | hotkilns.com |     |   |

|          |   |
|----------|---|
| TITLE    | MODEL E18T-EU-230 EASY-FIRE<br>1 PHASE-WYE WIRING DIAGRAM |
| SCALE    | 1 = 8   |
| DATE     | 12/16/04  |
| DRAWN BY | G.D.L.  |

|   |          |                      |
|---|----------|----------------------|
| REV #   | DATE     | REVISION DESCRIPTION |
| 0   | 12/16/04 | FIRST ISSUE          |
| MADE FROM<br>FILE NAME<br>L:\E18T\E18T-EU-230 EASY-FIRE<br>K282-154.DWG |          |                      |
| DRAWING NO.<br>K282-154 1/1   |          |                      |

**NOTES:**

Control Wire:  
16 AWG, 105°C  
Power Wire:  
10 AWG, 150°C

Industrial & commercial applications may require the installation of a **LOCKOUT/TAGOUT** device to prevent the Kiln from operating during maintenance.

This Kiln is recommended to be wired & connected to an approved U. L. & NEC configured receptacle controlled with a disconnect switch and properly fused according to the KW load load specification listed on the Kiln Nameplate. L&L Kiln Mfg., Inc., also recommends fuses rather than circuit breakers to prevent nuisance tripping.

| Model                  |                                    |
|------------------------|------------------------------------|
| <b>E18T-EU-415-3PY</b> |                                    |
| VOLTAGE                | 415 / 3-Y / 50-60                  |
| WATTS                  | ~ 8800                             |
| FULL LOAD AMPS         | L1   L2   L3<br>13.3   13.3   13.3 |
| POWER SUPPLY           | FUSE   WIRE<br>20A   10 AWG        |
| ELEMENTS (E-E-18S/41)  | QTY   OHMS<br>6   7.9              |

**SAFETY SWITCH BY CUSTOMER**  
Connect to  
415 Volt, 4 Wire, Three Phase Wye  
50 or 60 Cycles.

**LOOKING INSIDE CONTROL PANEL**

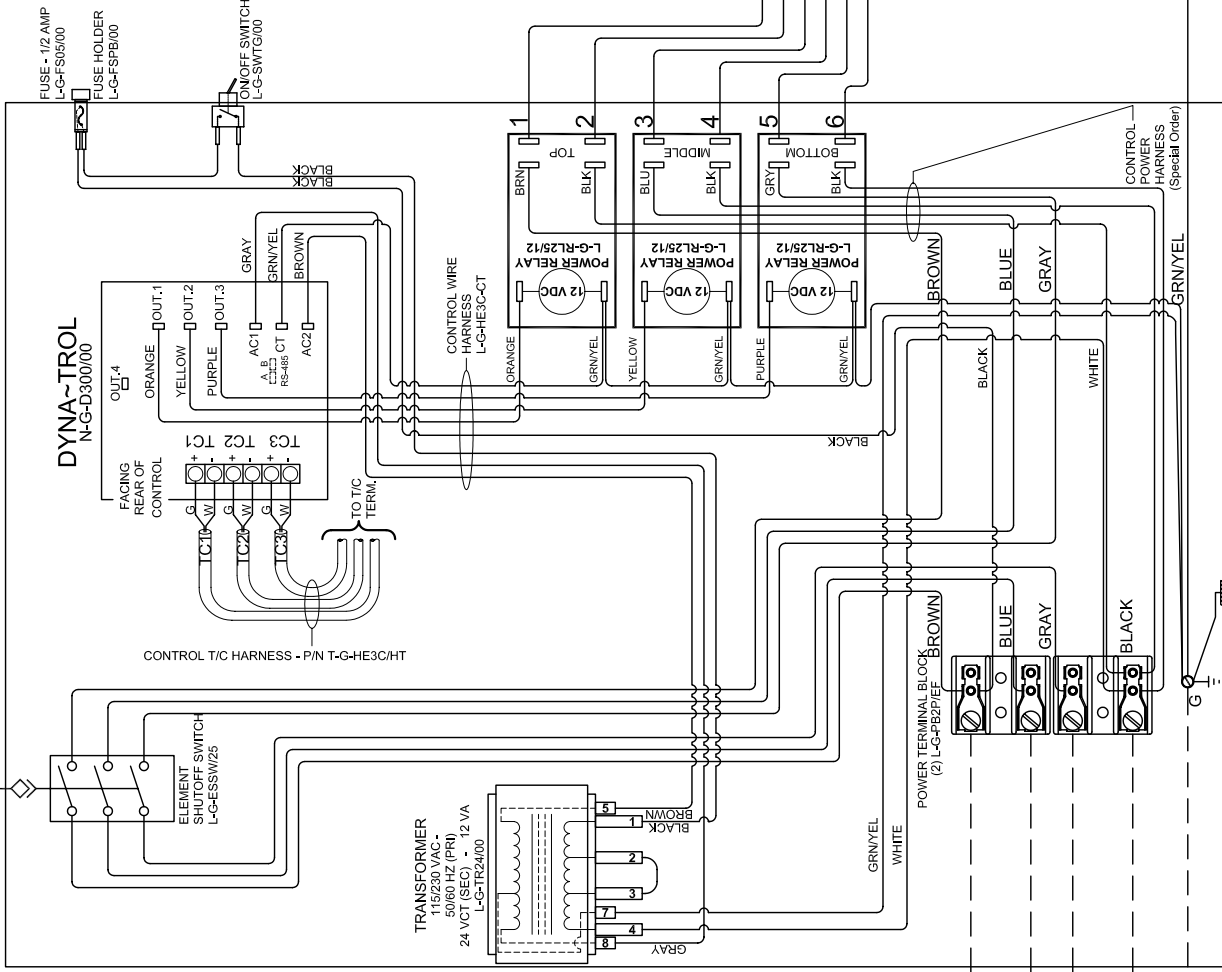

**LOOKING AT OUTSIDE OF ELEMENT COVER PANEL**

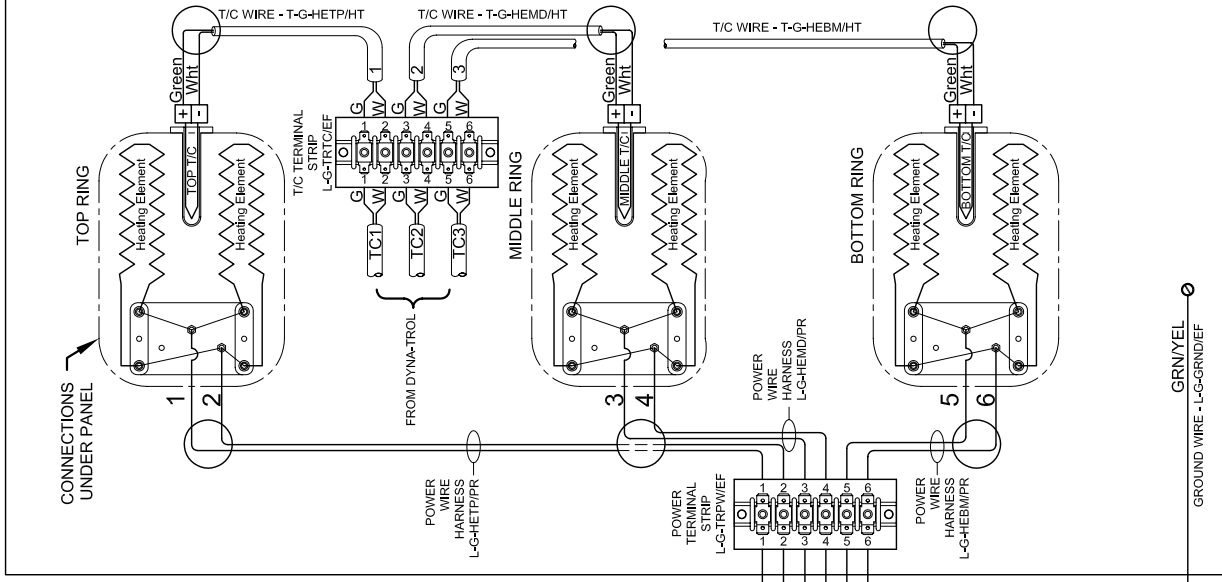

DRAWING NO. **K282-155 1/1** REV. 0  
SHEET OF 0  
8 CREEK PARKWAY  
PO BOX 1898  
BOOTHWYN, PA 19061  
**L&L Kilns**  
lorkilns.com

TITLE **MODEL E18T-EU-415-3PY EASY-FIRE 3 PHASE-WYE WIRING DIAGRAM**  
SCALE 1 = 8

DATE 12/16/04

DRAWN BY **G.D.L.**

FILE NAME **L:\E18T-KILN\EASY-FIRE**  
DRAWN FROM **K282-155.DWG**  
MADE FROM **K2904-154.DWG**

**NOTES:**

Control Wire:  
16 AWG, 105°C  
Power Wire:  
10 AWG, 150°C

Industrial & commercial applications may require the installation of a LOCKOUT/TAGOUT device to prevent the Kiln from operating during maintenance.

This Kiln is recommended to be wired & connected to an approved U. L. & NEC configured receptacle controlled with a disconnect switch and properly fused according to the KW load load specification listed on the Kiln Nameplate. L&L Kiln Mfg., Inc., also recommends fuses rather than circuit breakers to prevent nuisance tripping.

| Model                 |                             |
|-----------------------|-----------------------------|
| <b>E23S-EU-230</b>    |                             |
| VOLTAGE               | 230 / 1 / 50-60             |
| WATTS                 | ~ 8860                      |
| FULL LOAD AMPS        | L1   L2   L3<br>39.4   39.4 |
| POWER SUPPLY          | FUSE WIRE<br>50A   10 AWG   |
| ELEMENTS (E-E-23SX/4) | QTY   OHMS<br>4   21.5      |



**SAFETY SWITCH BY CUSTOMER**  
Connect to  
230 Volt / Single Phase  
50 or 60 Cycles.

**LOOKING INSIDE CONTROL PANEL**

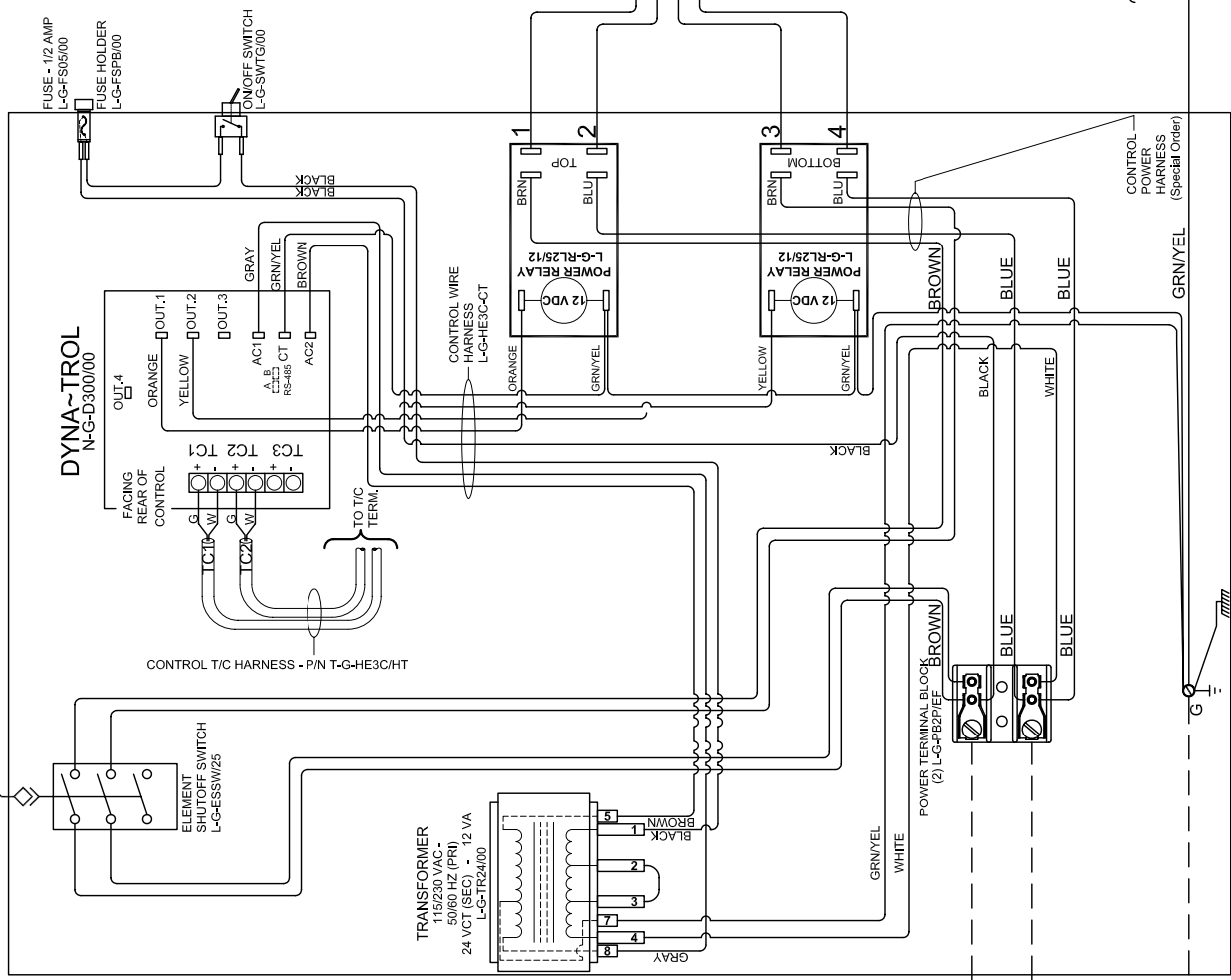

**LOOKING AT OUTSIDE OF ELEMENT COVER PANEL**

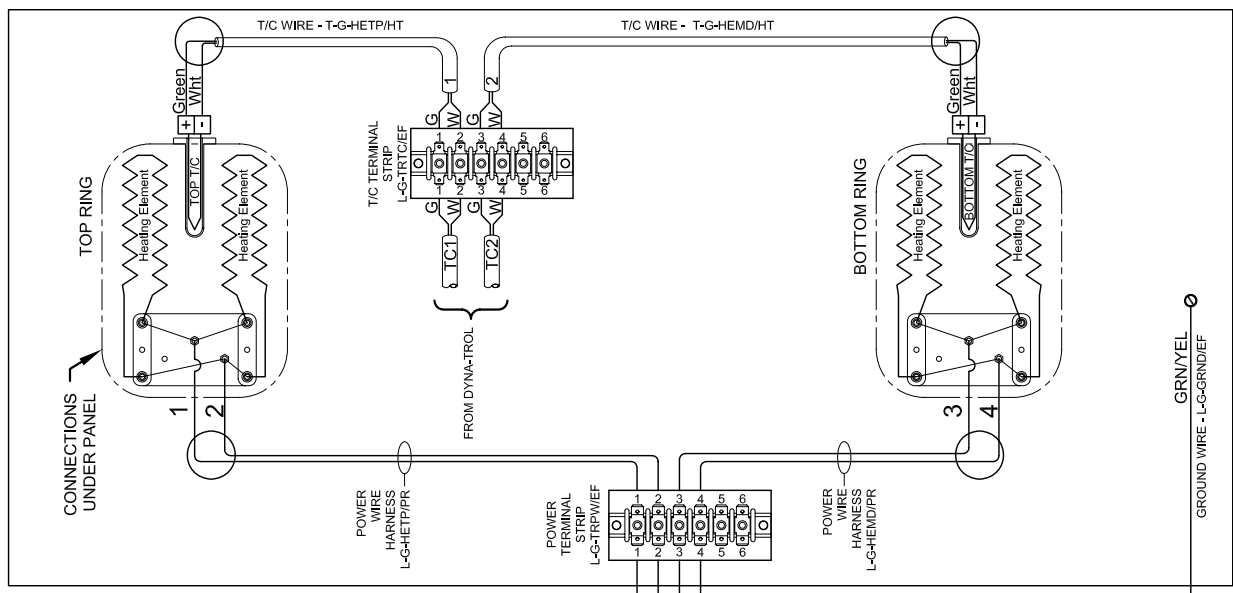

DRAWING NO. **K284-154 1/1** REV 0  
SHEET OF 0

8 CREEK PARKWAY  
PO BOX 1898  
BOOTHWYN, PA 19061  
**L&L Kilns**  
lorkilns.com

TITLE **MODEL E23S-EU-230 EASY-FIRE KILN  
1 PHASE WIRING DIAGRAM**

SCALE **1 = 8**

DATE **12/17/04**

DRAWN BY **G.D.L.**

MADE FROM **L&L KILN/EASY-FIRE  
K284-154.DWG**

| REV # | DATE     | REVISION DESCRIPTION |
|-------|----------|----------------------|
| 0     | 12/17/04 | FIRST ISSUE          |

**NOTES:**

Control Wire:  
16 AWG, 105°C  
Power Wire:  
10 AWG, 150°C

Industrial & commercial applications may require the installation of a LOCKOUT/TAGOUT device to prevent the Kiln from operating during maintenance.

This Kiln is recommended to be wired & connected to an approved U. L. & NEC configured receptacle controlled with a disconnect switch and properly fused according to the KW load load specification listed on the Kiln Nameplate. L&L Kiln Mfg., Inc., also recommends fuses rather than circuit breakers to prevent nuisance tripping.

| Model                  |                 |
|------------------------|-----------------|
| <b>E23T-EU-230</b>     |                 |
| VOLTAGE                | 230 / 1 / 50-60 |
| WATTS                  | ~ 10,580        |
| FULL LOAD AMPS         | L1   L2   L3    |
| POWER SUPPLY           | 63A   10 AWG    |
| ELEMENTS (E-E-23TL/4H) | QTY   OHMS      |
|                        | 6   26.5        |



**SAFETY SWITCH BY CUSTOMER**  
Connect to  
230 Volt / Single Phase Wye  
50 or 60 Cycles.

**LOOKING INSIDE CONTROL PANEL**

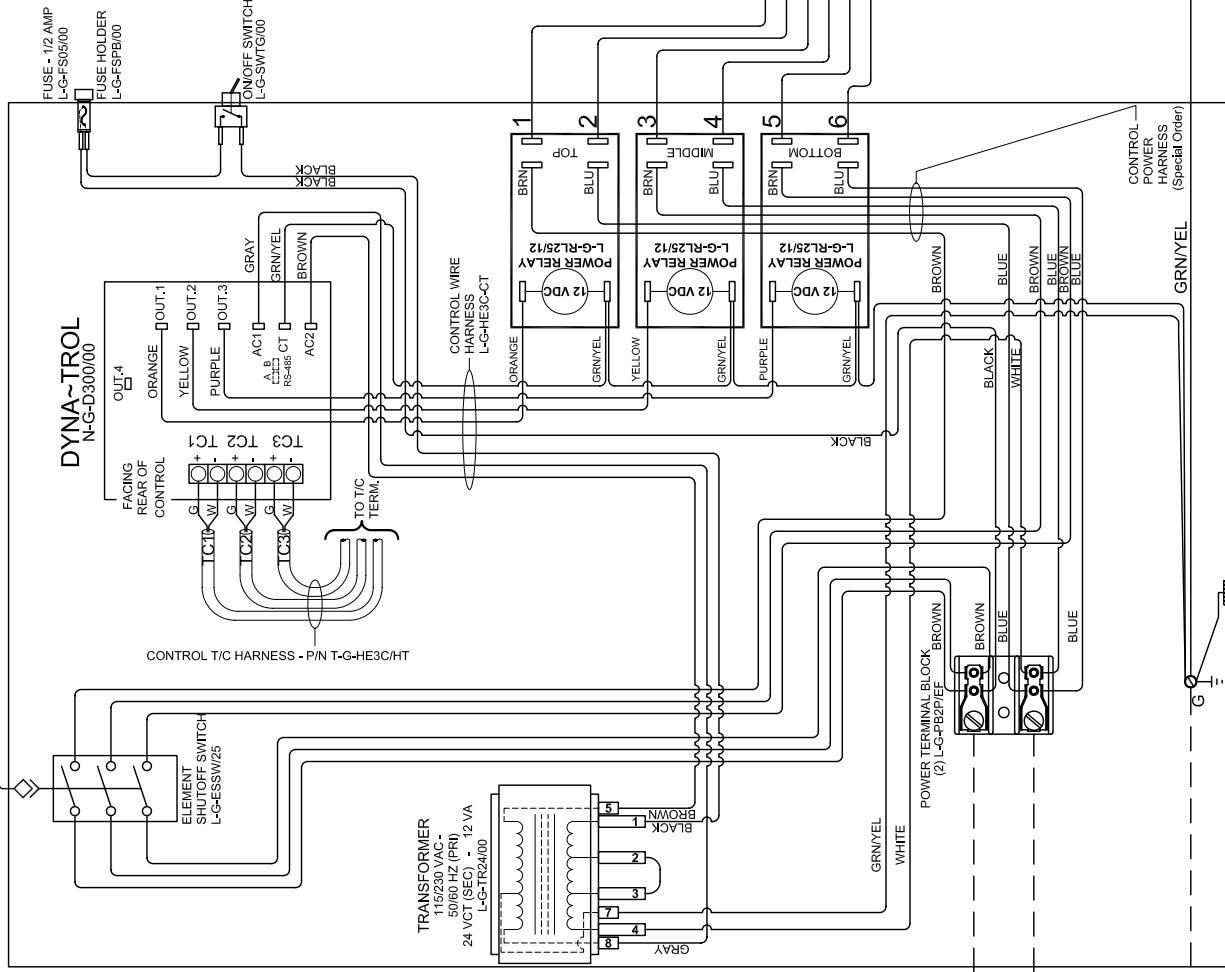

**LOOKING AT OUTSIDE OF ELEMENT COVER PANEL**

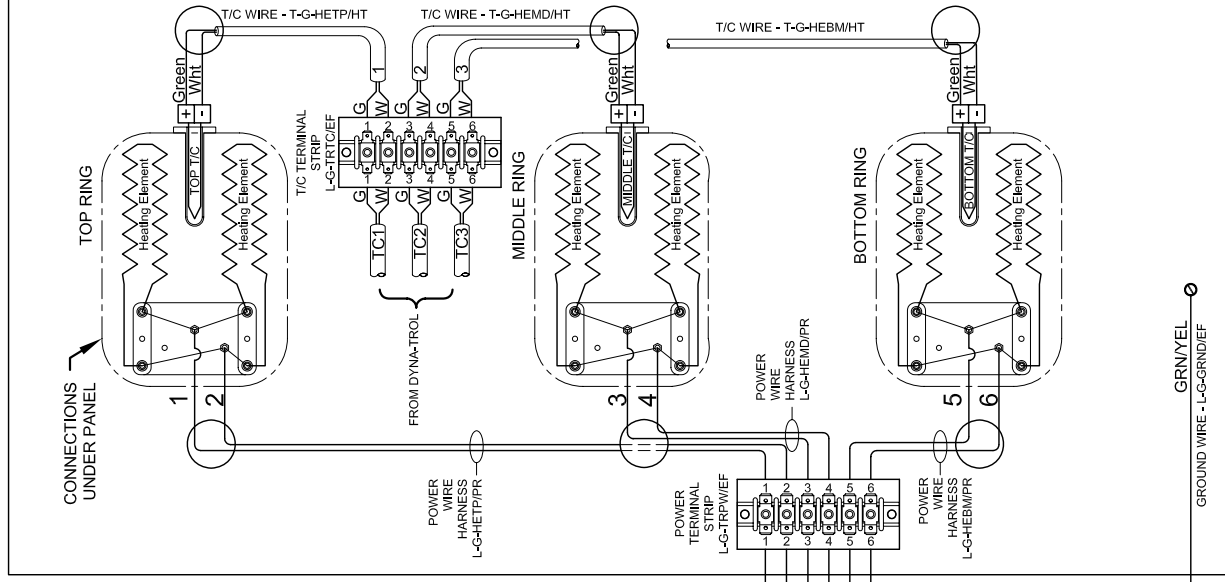

DRAWING NO. **K286-155** 1/1 0  
 SHEET OF 0  
 REV 0  
 8 CREEK PARKWAY  
 PO BOX 1898  
 BOOTHWYN, PA 19061  
**L&L Kilns**  
 lorkilns.com

TITLE **MODEL E23T-EU-230 EASY-FIRE**  
**1 PHASE-WYE WIRING DIAGRAM**

SCALE **1 = 8**  
 DATE **12/17/04**

DRAWN BY **G.D.L.**

MADE FROM **K286-154.DWG**  
 FILE NAME **L:\EIL\KILN\EASY-FIRE**  
 REVISION DESCRIPTION

**NOTES:**

Control Wire:  
16 AWG, 105°C  
Power Wire:  
10 AWG, 150°C

Industrial & commercial applications may require the installation of a **LOCKOUT/TAGOUT** device to prevent the Kiln from operating during maintenance.

This Kiln is recommended to be wired & connected to an approved U. L. & NEC configured receptacle controlled with a disconnect switch and properly fused according to the KW load load specification listed on the Kiln Nameplate. L&L Kiln Mfg., Inc., also recommends fuses rather than circuit breakers to prevent nuisance tripping.

| Model                  |                                    |
|------------------------|------------------------------------|
| <b>E23T-EU-415-3PY</b> |                                    |
| VOLTAGE                | 415 / 3-Y / 50-60                  |
| WATTS                  | ~11,400                            |
| FULL LOAD AMPS         | L1   L2   L3<br>17.3   17.3   17.3 |
| POWER SUPPLY           | FUSE WIRE<br>25A 10 AWG            |
| ELEMENTS               | QTY OHMS<br>(E-E-23TL/42) 6   24.5 |

**SAFETY SWITCH BY CUSTOMER**  
Connect to  
415 Volt, 4 Wire, Three Phase Wye  
50 or 60 Cycles.

**LOOKING INSIDE CONTROL PANEL**

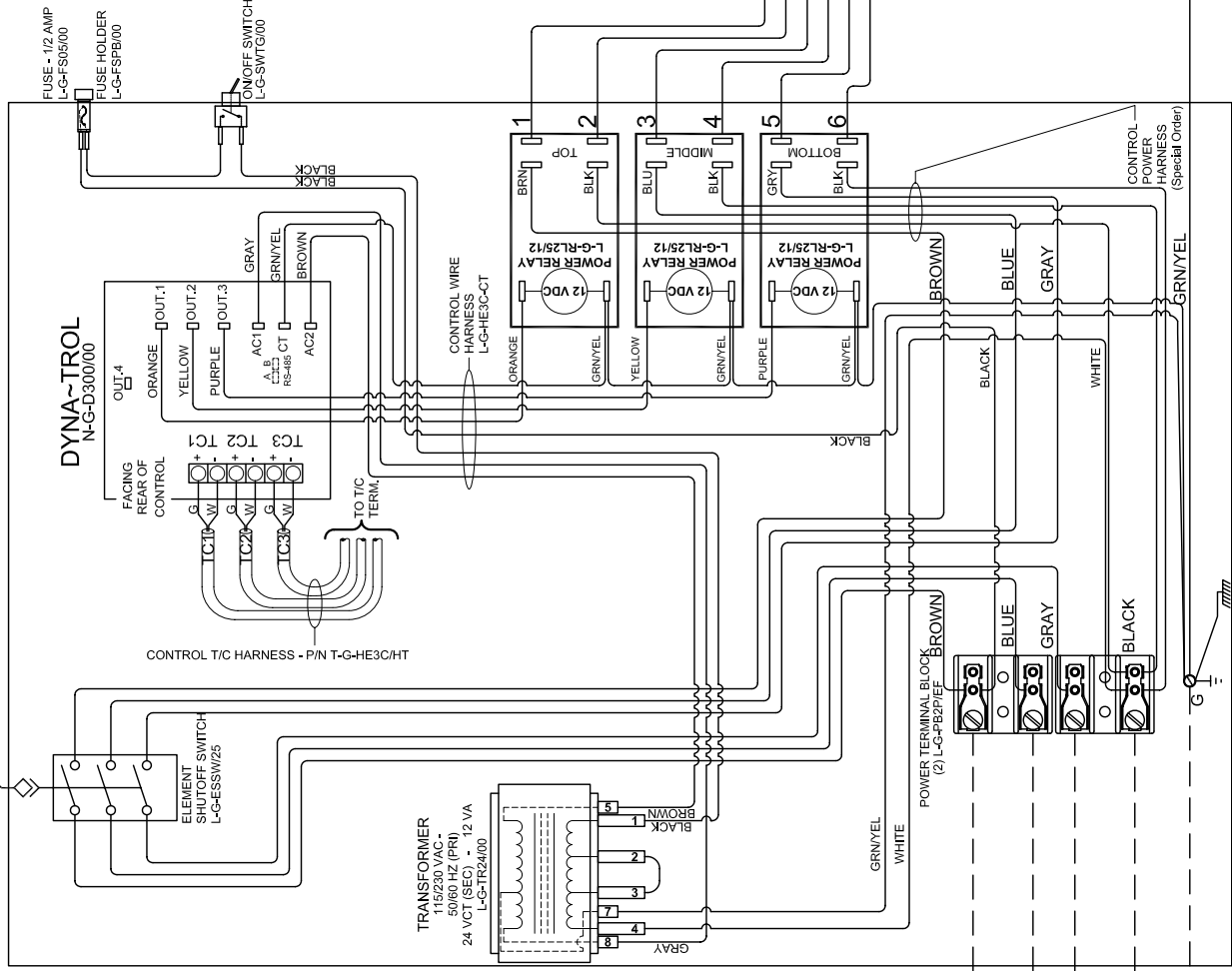

**LOOKING AT OUTSIDE OF ELEMENT COVER PANEL**

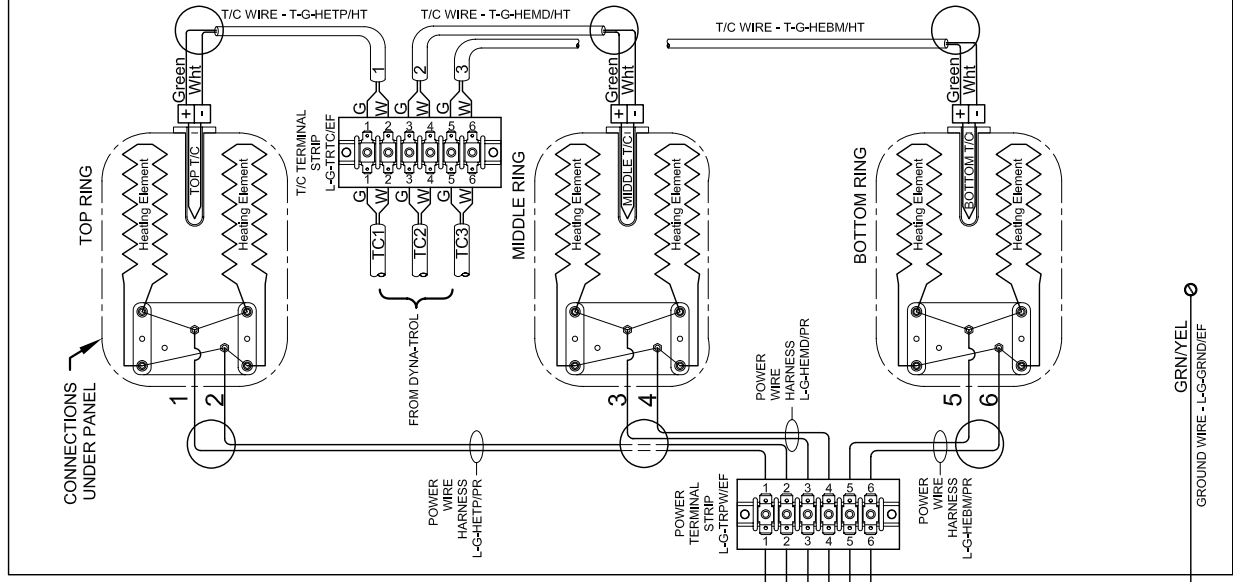

DRAWING NO. **K286-156 1/1** REV 0  
SHEET OF 0  
8 CREEK PARKWAY  
PO BOX 1898  
BOOTHWYN, PA 19061  
**L&L Kilns**  
lorkilns.com

TITLE **MODEL E23T-EU-415-3PY EASY-FIRE 3 PHASE-WYE WIRING DIAGRAM**  
SCALE 1 = 8

DATE **12/17/04**

DRAWN BY **G.D.L.**

FILE NAME **L:\EIL\KILN\EASY-FIRE**  
K286-156.DWG  
MADE FROM **K282-155.DWG**



**NOTES:**

Control Wire:  
16 AWG, 105°C  
Power Wire:  
10 AWG, 150°C

Industrial & commercial applications may require the installation of a **LOCKOUT/TAGOUT** device to prevent the Kiln from operating during maintenance.

This Kiln is recommended to be wired & connected to an approved U. L. & NEC configured receptacle controlled with a disconnect switch and properly fused according to the KW load load specification listed on the Kiln Nameplate. L&L Kiln Mfg., Inc., also recommends fuses rather than circuit breakers to prevent nuisance tripping.

| Model                  |                             |
|------------------------|-----------------------------|
| <b>E28S-EU-230</b>     |                             |
| VOLTAGE                | 230 / 1 / 50-60             |
| WATTS                  | ~10,500                     |
| FULL LOAD AMPS         | L1   L2   L3<br>47.7   47.7 |
| POWER SUPPLY           | FUSE   WIRE<br>63A   10 AWG |
| ELEMENTS (E-E-28S1/41) | QTY   OHMS<br>4   17.8      |



**SAFETY SWITCH BY CUSTOMER**  
Connect to  
230 Volt / Single Phase  
50 or 60 Cycles.

**LOOKING INSIDE CONTROL PANEL**

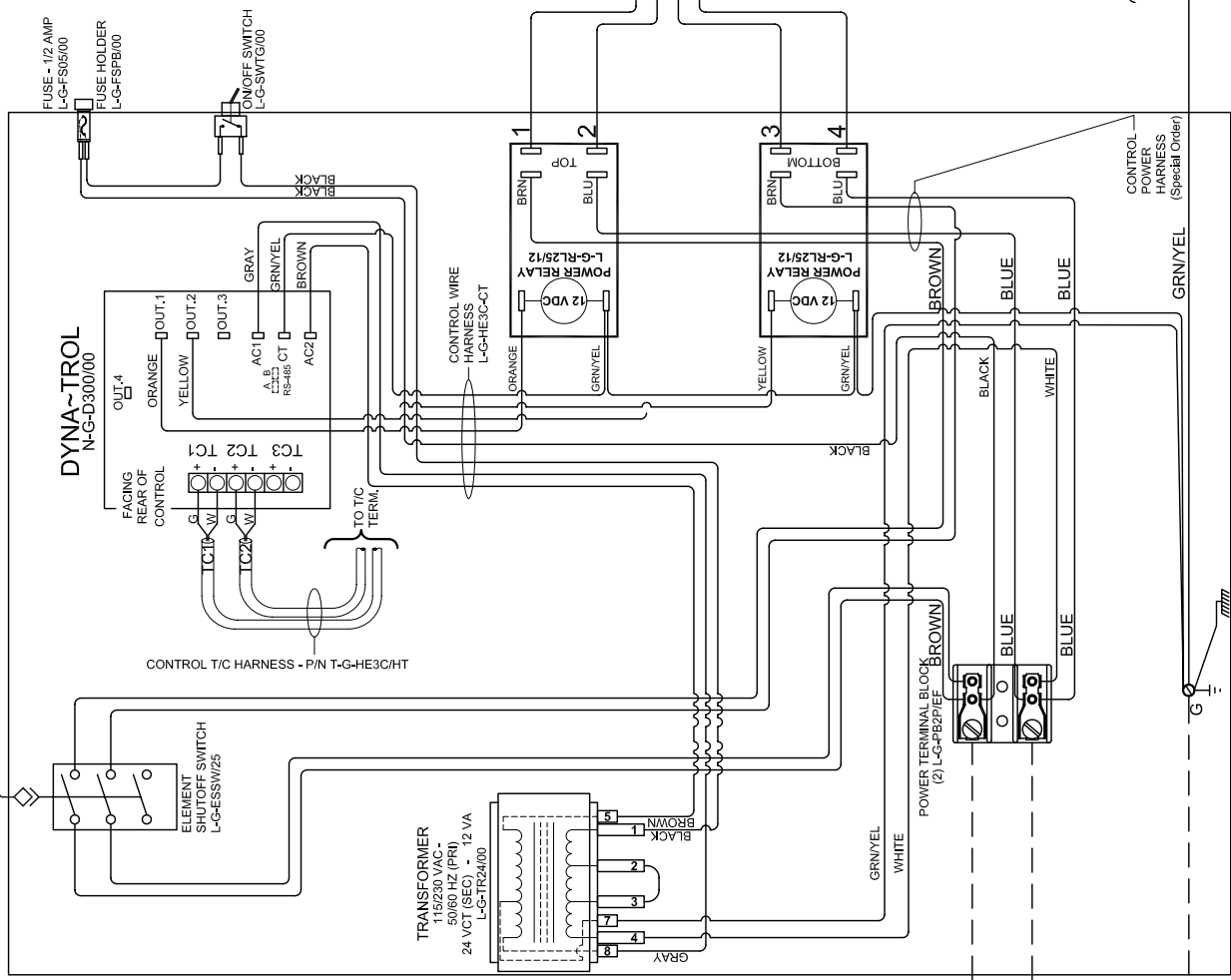

**LOOKING AT OUTSIDE OF ELEMENT COVER PANEL**

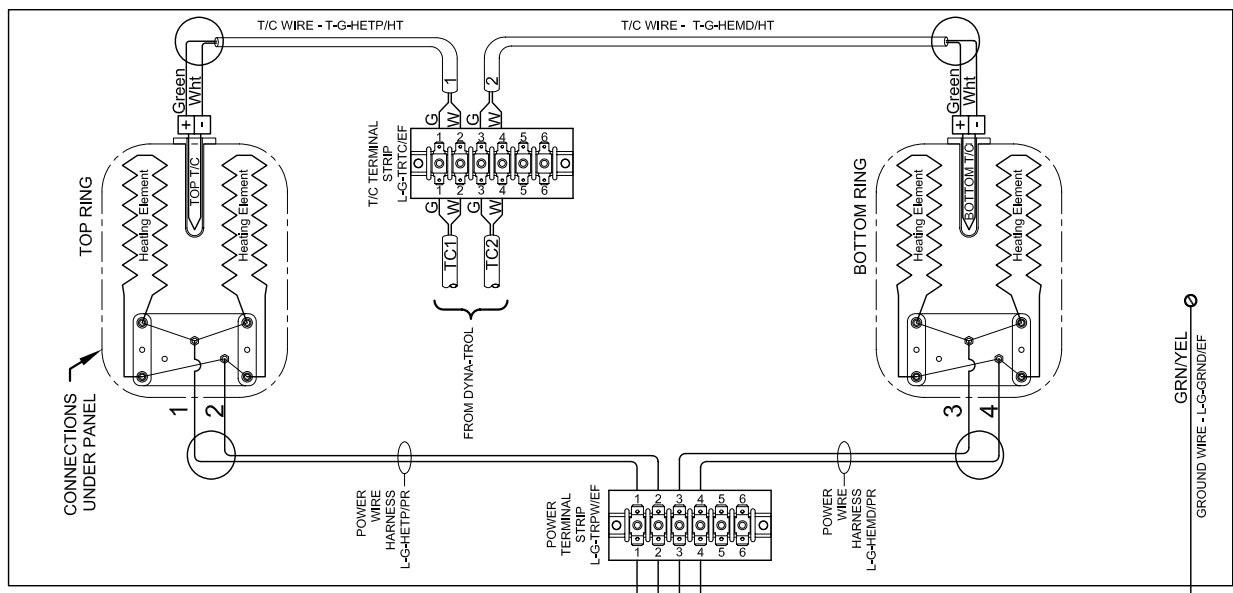

**NOTES:**

Control Wire:  
16 AWG, 105°C  
Power Wire:  
10 AWG, 150°C

Industrial & commercial applications may require the installation of a LOCKOUT/TAGOUT device to prevent the Kiln from operating during maintenance.

This Kiln is recommended to be wired & connected to an approved U. L. & NEC configured receptacle controlled with a disconnect switch and properly fused according to the KW load load specification listed on the Kiln Nameplate. L&L Kiln Mfg., Inc., also recommends fuses rather than circuit breakers to prevent nuisance tripping.

| Model                  |                                  |
|------------------------|----------------------------------|
| <b>E28T-EU-415-3PY</b> |                                  |
| VOLTAGE                | 415 / 3-Y / 50-60                |
| WATTS                  | ~15060                           |
| FULL LOAD AMPS         | L1 L2 L3<br>22.8 22.8 22.8       |
| POWER SUPPLY           | FUSE WIRE<br>30A 10 AWG          |
| ELEMENTS               | QTY OHMS<br>(E-E-28TX/42) 6 18.6 |

L1 ○  
L2 ○  
L3 ○  
N ○  
G ○

**SAFETY SWITCH BY CUSTOMER**  
Connect to  
415 Volt, 4 Wire, Three Phase Wye  
50 or 60 Cycles.

**LOOKING INSIDE CONTROL PANEL**

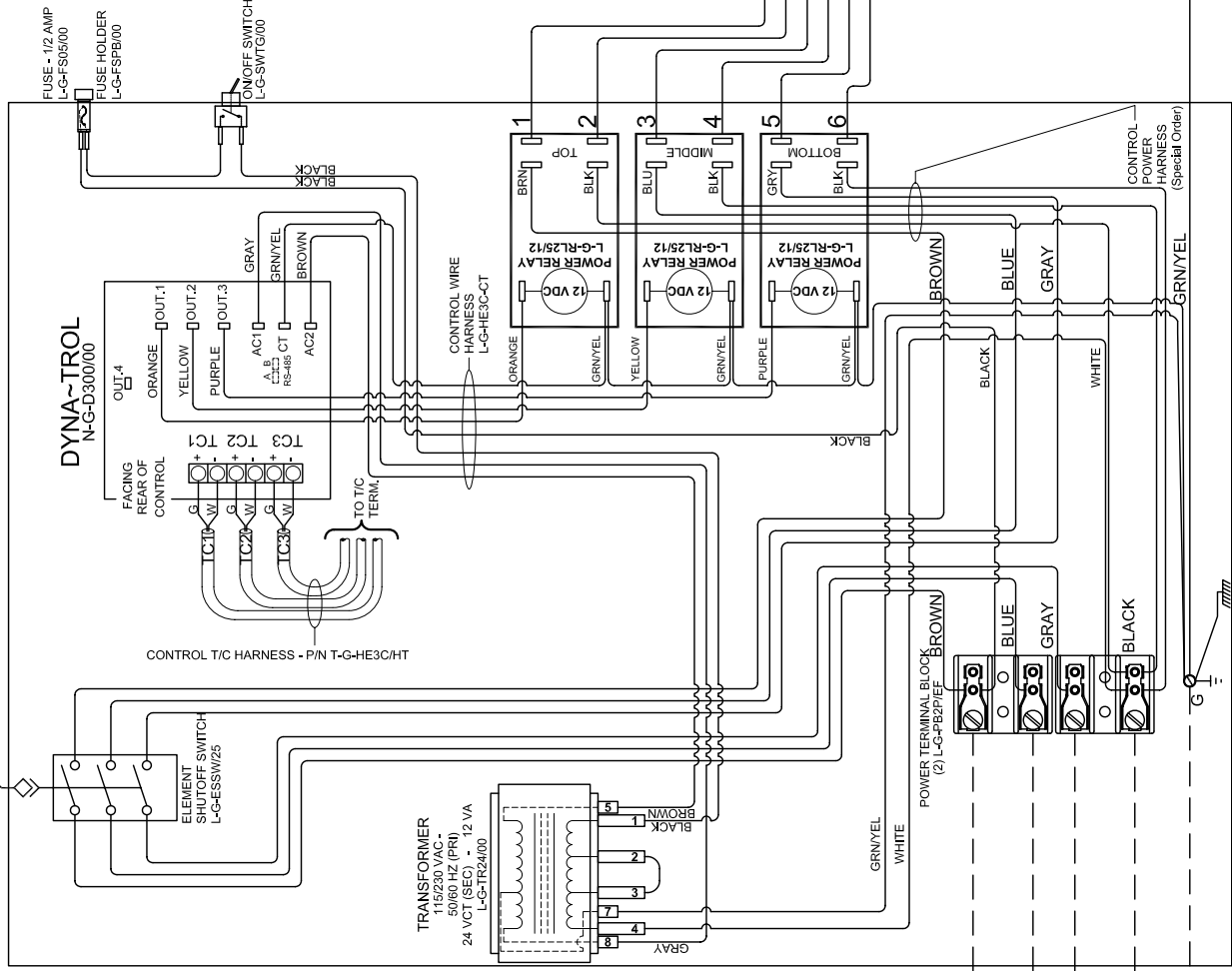

**LOOKING AT OUTSIDE OF ELEMENT COVER PANEL**

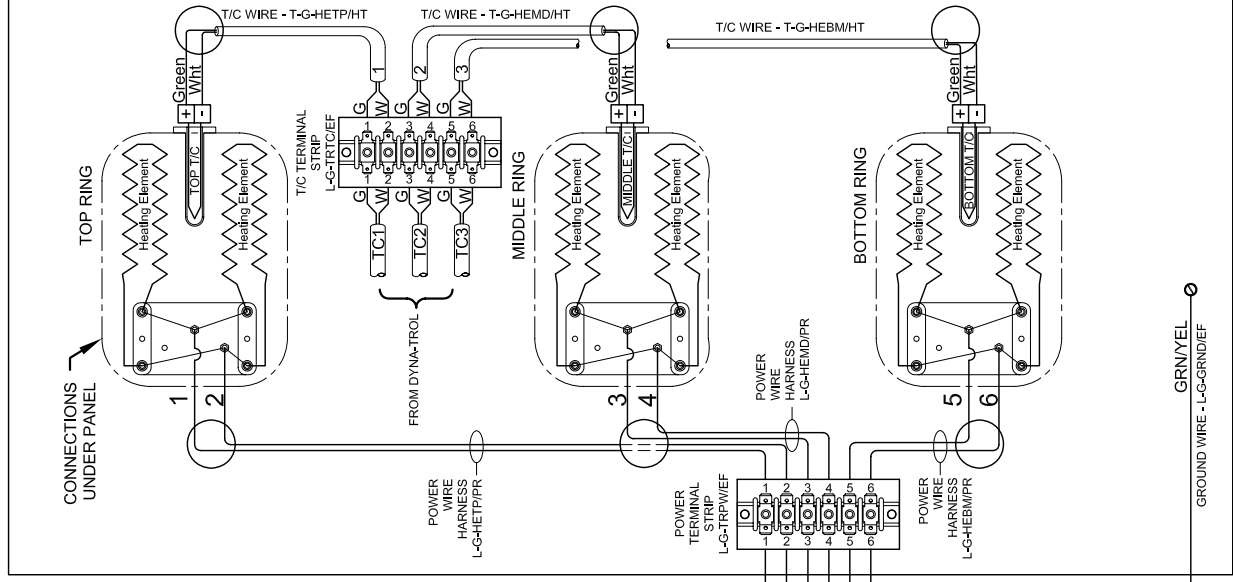

DRAWING NO. **K290-154 1/1** REV 0

8 CREEK PARKWAY  
PO BOX 1898  
BOOTHWYN, PA 19061

**L&L Kilns**  
lolkilns.com

TITLE **MODEL E28T-EU-415-3PY EASY-FIRE 3 PHASE-WYE WIRING DIAGRAM**

SCALE **1 = 8**

DATE **11/30/04**

DRAWN BY **G.D.L.**

REVISION DESCRIPTION

| REV # | DATE     | DESCRIPTION |
|-------|----------|-------------|
| 0     | 11/30/04 | 11/30/04    |

MADE FROM FILE NAME **L:VEILLIKILNEASYFIRE** K290-154.DWG

MADE FROM FILE NAME **K290-153.DWG**



**NOTES:**

Control Wire:  
16 AWG, 105°C

Power Wire:  
10 AWG, 150°C

Industrial & commercial applications may require the installation of a **LOCKOUT/TAGOUT** device to prevent the Kiln from operating during maintenance.

This Kiln is recommended to be wired & connected to an approved U. L. & NEC configured receptacle controlled with a disconnect switch and properly fused according to the KW load load specification listed on the Kiln Nameplate. L&L Kiln Mfg., Inc., also recommends fuses rather than circuit breakers to prevent nuisance tripping.

| Model                  |                 |
|------------------------|-----------------|
| <b>E28T-EU-230</b>     |                 |
| VOLTAGE                | 230 / 1 / 50-60 |
| WATTS                  | ~ 10,580        |
| FULL LOAD AMPS         | L1   L2   L3    |
| POWER SUPPLY           | 63A   10 AWG    |
| ELEMENTS (E-E-28TL/48) | QTY   OHMS      |
|                        | 6   26.5        |

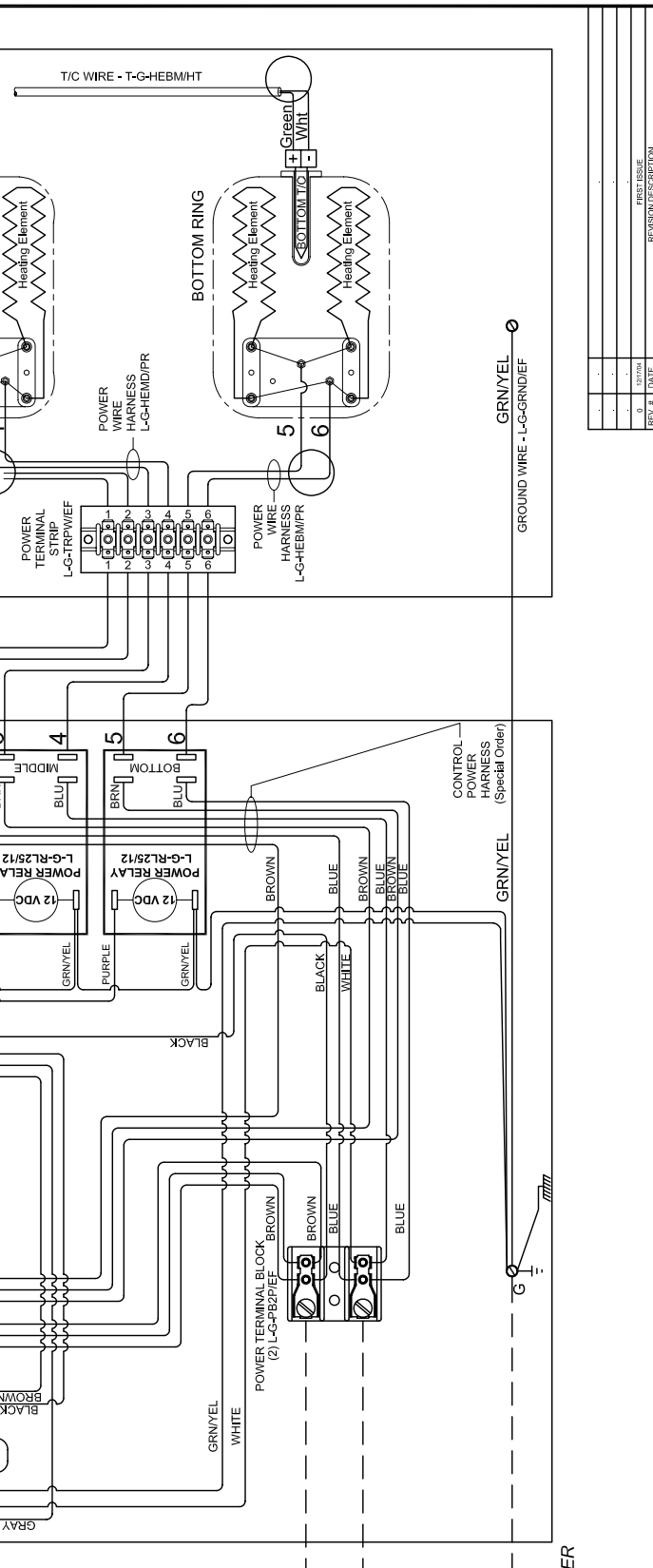
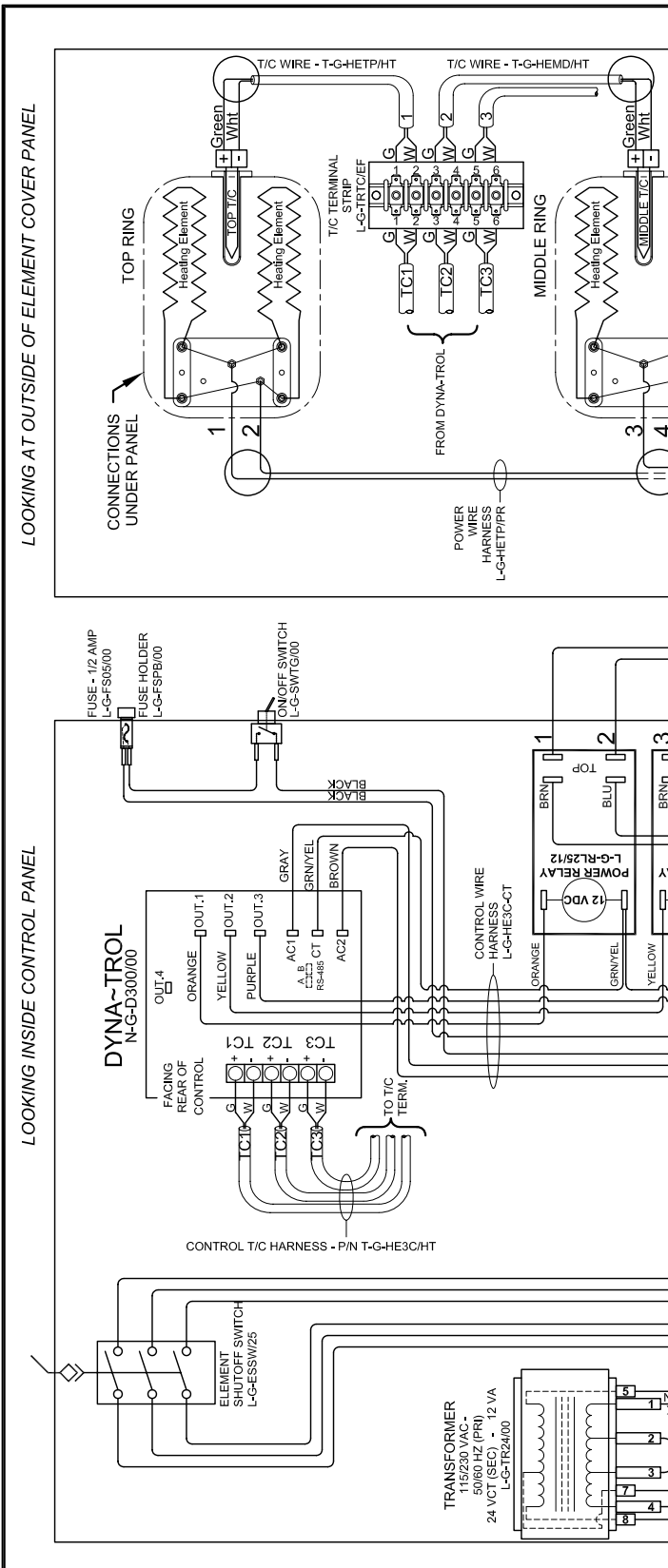
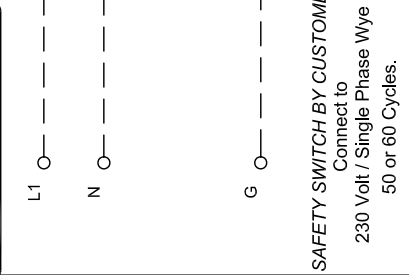

|                      |   |          |       |             |   |
|----------------------|---|----------|-------|-------------|---|
| DRAWING NO.          | K290-155  | SHEET OF | 1/1   | REV         | 0 |
| TITLE                | MODEL E28T-EU-230 EASY-FIRE<br>1 PHASE-WYE WIRING DIAGRAM |          |       |             |   |
| SCALE                | 1 = 8   |          |       |             |   |
| DATE                 | 12/17/04  |          |       |             |   |
| DRAWN BY             | G.D.L.  |          |       |             |   |
| FILE NAME            | L:\EIL\KILN\EASY-FIRE                                     |          |       |             |   |
| MADE FROM            | K290-155.DWG  |          |       |             |   |
| REVISION DESCRIPTION | REV #   | DATE     | SYSTM | FIRST ISSUE |   |
|                      | 0   |          |       |             |   |



**Easy-Fire**

**TROUBLESHOOTING  
& PARTS LIST**



# PARTS FOR YOUR L&L EASY-FIRE KILN (EUROPEAN VERSION)

## TABLE OF CONTENTS

|  |    |
|--|----|
| TABLE OF CONTENTS .....                  | 1  |
| HOW TO ORDER PARTS .....                 | 1  |
| ELEMENTS .....                           | 1  |
| PEEPHOLE PLUGS .....                     | 3  |
| ELEMENT TERMINAL BOARDS .....            | 3  |
| THERMOCOUPLES .....                      | 3  |
| POWER TERMINAL BLOCKS .....              | 4  |
| POWER TERMINAL STRIP .....               | 4  |
| CONTROL FUSE .....                       | 4  |
| ON/OFF TOGGLE SWITCH .....               | 5  |
| ELEMENT SHUT-OFF SWITCH SYSTEM .....     | 5  |
| POWER RELAYS .....                       | 5  |
| DYNATROL BOARD .....                     | 6  |
| CONTROL TRANSFORMER .....                | 6  |
| WIRE HARNESSSES & BUSHINGS .....         | 6  |
| COMPLETE CONTROL BOXES .....             | 6  |
| WIRE & TERMINALS .....                   | 6  |
| CERAMIC ELEMENT HOLDERS .....            | 8  |
| TOP & BOTTOM FIREBRICK SLABS .....       | 8  |
| SIDE FIREBRICK - BRICKS & SECTIONS ..... | 9  |
| CEMENT & BRICK REPAIR .....              | 9  |
| SCREWS, BOLTS, NUTS, WASHERS .....       | 10 |
| ELEMENT COVER BOXES .....                | 10 |
| CONTROL BOX .....                        | 10 |
| EASY-LIFT SPRING HINGE .....             | 11 |
| NON-SPRING HINGE FOR e18 .....           | 12 |
| STANDS .....                             | 12 |
| MISC HARDWARE .....                      | 13 |

## HOW TO ORDER PARTS

### How to Place an Order

Order parts from your local distributor.

### Prices

Prices in this parts list are in US dollars. However, your local distributor will have prices listed in the proper currency for you.

### Have the Nameplate Information

You can get Model Number, Serial Number and Voltage information about your kiln from the Data Nameplate affixed to your kiln. Please have this available when ordering parts.

## ELEMENTS

### ORDER THE CORRECT VOLTAGE ELEMENT

The voltage and phase of your kiln is listed on the data nameplate on your kiln.

Be sure you order the proper voltage and phase elements. Phase does matter with the Easy-Fire elements because we vary power and resistance to maximize the power output on three phase kilns.

Elements in each kiln are all the same resistance - there are no graded elements top to bottom to worry about.

### MODEL e18S-eu or e18T ELEMENTS

There are four elements in the e23S-eu kiln.

E-E-18TX/41.....\$41.00  
e18S-eu-230 single phase, e18T-eu-230 single phase or  
e18T-eu-415Y three phase

### MODEL e23S-eu ELEMENTS

There are four elements in the e23S-eu kiln.

E-E-23SX/41.....\$41.00  
e23S-eu-230 single phase

### MODEL e23T-eu ELEMENTS

There are six elements in the e23T-eu kiln.

E-E-23TX/41.....\$41.00  
e23T-eu-230 single phase or e23T-eu-415Y three phase

### MODEL e28S-eu ELEMENTS

There are four elements in the e23S-eu kiln.

E-E-28SX/41.....\$41.00  
e28S-eu-230 single phase

### MODEL e28T-eu ELEMENTS - SINGLE PHASE

There are six elements in the e28T-eu kiln.

E-E-28TX/41.....\$41.00  
e28S-eu-230 single phase

### MODEL e28T-eu ELEMENTS - THREE PHASE

E-E-28TX/42.....\$41.00  
e28S-eu-415Y three phase

# PARTS FOR YOUR L&L EASY-FIRE KILN (EUROPEAN VERSION)

Photo of a single phase control panel for a three section e23T-eu or e28T-eu

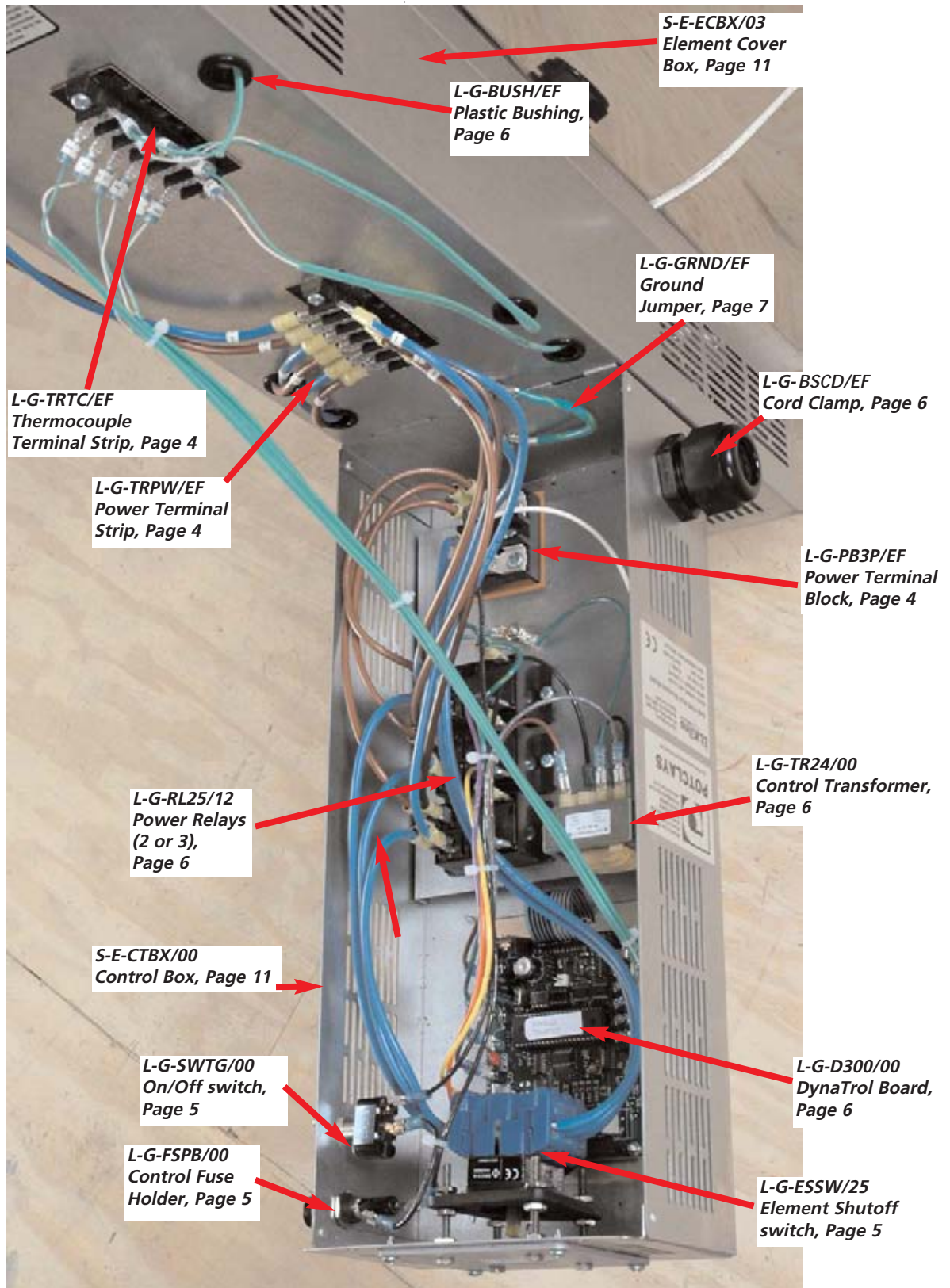



# PARTS FOR YOUR L&L EASY-FIRE KILN (EUROPEAN VERSION)

## PEEPHOLE PLUGS

**C-G-PEEP/00** .....\$7.50  
**Peep Hole Plugs** 25mm (1"OD) x 125mm (5") Long. These have a stepped head to act as a heat lock around the perimeter. Also used to plug the vent holes on the top of the kiln.

*Below is a C-G-PEEP/10 peephole plug:*



## ELEMENT TERMINAL BOARDS

### CERAMIC TERMINAL BLOCKS

**L-J-BK23/EF** .....\$30.00  
**All-Ceramic Element Connection Board For All Easy-Fire kilns.** Comes with terminal hardware and mounting screws.

*Below is the L-J-BK23/EF shown on an actual kiln:*

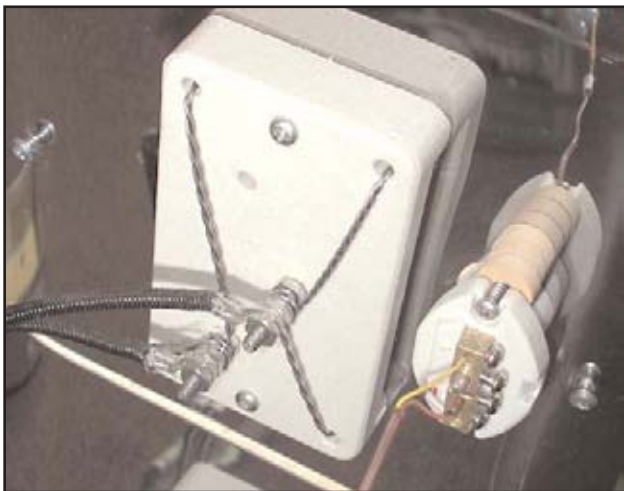

**M-G-TSET/00** .....\$3.45  
**Element Board Terminal Set.** Price is for the whole set. Includes: One #10-24 SS bolt 1-1/4" long, One SS lock washer, Three #10-24 SS nuts, Four #10 SS flat washers.

*Below is the complete Element Board Terminal Set:*

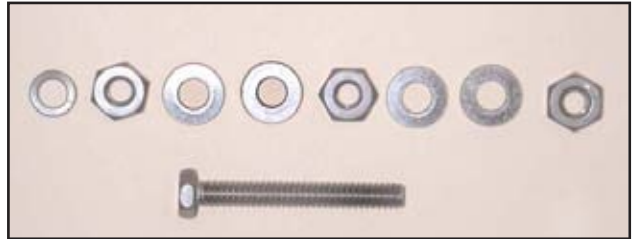

**M-A-SMS3/00**.....\$0.40  
**#8 x 1-1/2" long Stainless Steel Sheet Metal Screw.** #8 X 1 1/2" Phillips Pan Head. These are used to attach thermocouples to the kiln and to attach Element Terminal Blocks to kiln. (12 used on a 3 section kiln, 8 used on a 2 section kiln)

## THERMOCOUPLES

**T-G-E800/00** .....\$28.00  
**8 Gauge Type K Thermocouple** with ceramic terminal block. Mounting kit is not included.

*Below is a T-G-E800/00 8 Ga Thermocouple:*



**T-G-TUBE/00**.....\$25.00  
**Industrial Mullite Protection Tube.** This goes over the 8 gauge thermocouple and protects the thermocouple from rapid corrosion.

*Below is a T-G-TUBE/00 Thermocouple Protection Tube:*



**T-G-MKIT/00**.....\$6.50  
**Mounting Kit for Thermocouple.** Includes two screws and six 1/4" high ceramic standoffs.

# PARTS FOR YOUR L&L EASY-FIRE KILN (EUROPEAN VERSION)

Below is the mounting kit for thermocouples shown with a thermocouple:

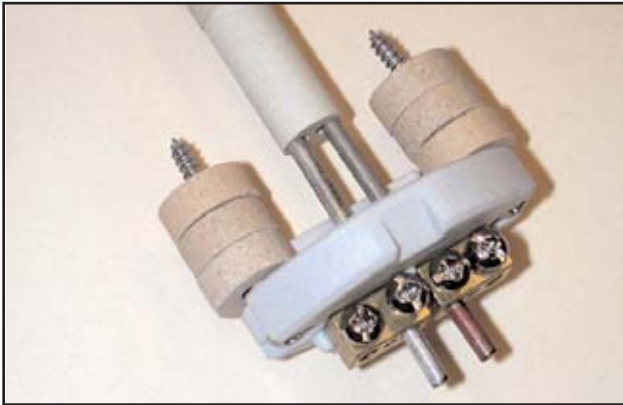

L-G-TRTC/EF .....\$16.00  
**Thermocouple Terminal Strip.**

Below is a L-G-TRTC/EF Thermocouple Terminal Strip:

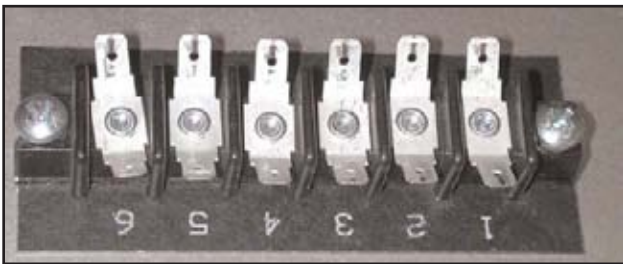

## POWER TERMINAL BLOCKS

The Power Terminal Blocks are the main terminal that the Power Cord gets attached to. The wires feed from this block to the Power Relays and Control Transformer.

L-G-PB2P/EF .....\$21.00  
**Single Phase Power Connection Block 2 pole.**

Below is a L-G-PB2P/EF 2 pole Connection Block:

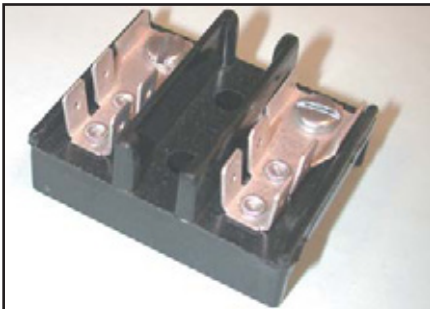

L-G-PB3P/EF .....\$27.00  
**Three Phase Power Connection Block 3 Pole**

Below is a L-G-PBLG/02 3 pole Power Connection Block:



## POWER TERMINAL STRIP

There is a Power Terminal Strip for connecting the Power Element Lead Wires and the Power Wires that go to the outputs of the Power Relays. There is also a similar but smaller one for the Thermocouple Lead Wires. These are mounted on the outside surface of the Element Cover Box and are covered by the piggy-backed Control Box when it closes.

L-G-TRPW/EF .....\$16.00  
**Power Terminal Strip.** (See photo on page 2 to see where it is located).

Below is a L-G-TRPW/EF Power Terminal Strip:



## CONTROL FUSE

This fuses the control circuit. It is located by the On/off switch and the fuse is accessible from outside the panel..

Below is a panel mounted fuse holder and fuse:



L-C-FS05/00.....\$1.25  
**1/2 Amp Fuse Panel Mount (3AG-1/2, 250V)**

L-G-FSPB/00.....\$13.00  
**Panel Mount Fuse Holder for Control Fuse**

# PARTS FOR YOUR L&L EASY-FIRE KILN (EUROPEAN VERSION)

## ON/OFF TOGGLE SWITCH

L-G-SWTG/00 .....\$16.00  
**On/Off Toggle Switch.** (See photo on page 2 to see where it is located).

*Below is the L-G-SWTG/00 On/Off Switch:*

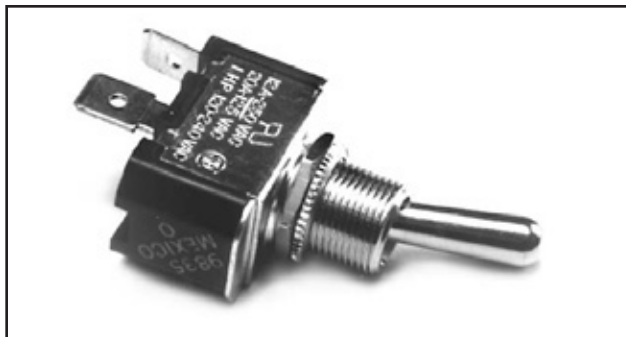

## ELEMENT SHUT-OFF SWITCH SYSTEM

L-G-ESSW/25.....\$45.00  
 This is the three pole 25 amp switch that turns off power to the elements.

*Below is a 25 Amp shut-off switch (L-G-ELSF/25) shown mounted in the control panel.*



L-G-ESAT/EZ .....\$35.00  
**Actuator Tool** with machined rectangular block on one end and thread on other end.

*Below is the Actuator:*

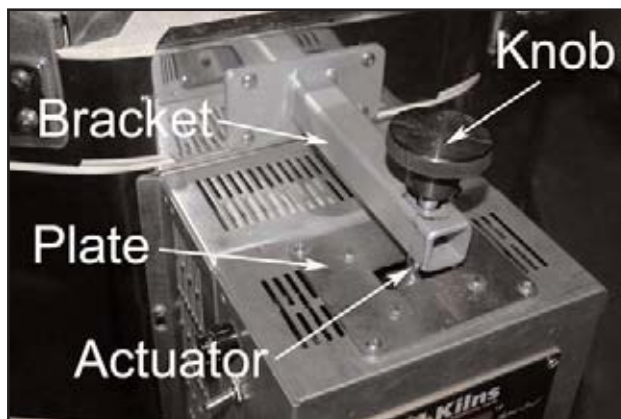

L-G-ESPL/EZ .....\$10.00  
**Plate** that mounts onto the control panel with rectangular slot.

L-G-ESKN/EZ.....\$7.50  
**Knob** for actuator

L-G-ESBR/EZ.....\$35.00  
**Bracket** that attaches to the door of the kiln

## POWER RELAYS

L-G-RL25/12 .....\$27.00  
**25 Amp Enclosed Power Relay**, 12 Volt Coil. (See photo on page 2 to see where it is located).

*Below is a 25 Amp enclosed power relay with a 12 volt coil (L-G-RL25/12).*





# PARTS FOR YOUR L&L EASY-FIRE KILN (EUROPEAN VERSION)

## DYNATROL BOARD

N-G-D300/00 .....\$260.00

**DynaTrol Electronic Board.** (See photo on page 2 to see where it is located).

*Below is the N-G-D300/00 Board viewed from the back.*

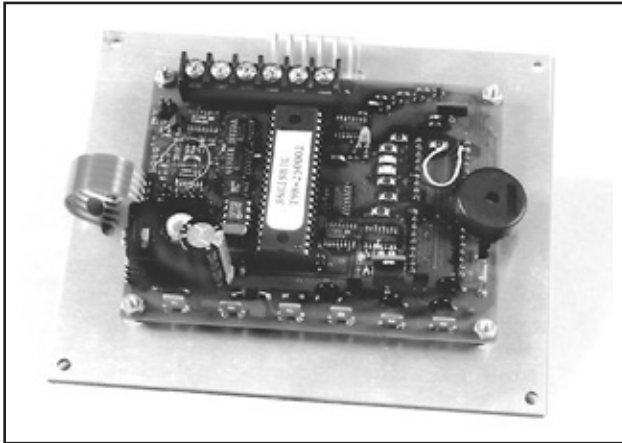

## CONTROL TRANSFORMER

L-G-TR24/00 .....\$30.00

**12 VA Control Transformer.** (See photo on page 2 to see where it is located).

*Below is the L-G-TR24/00 12VA Control transformer. The arrow points to the terminal numbers that correspond to the wiring diagram:*

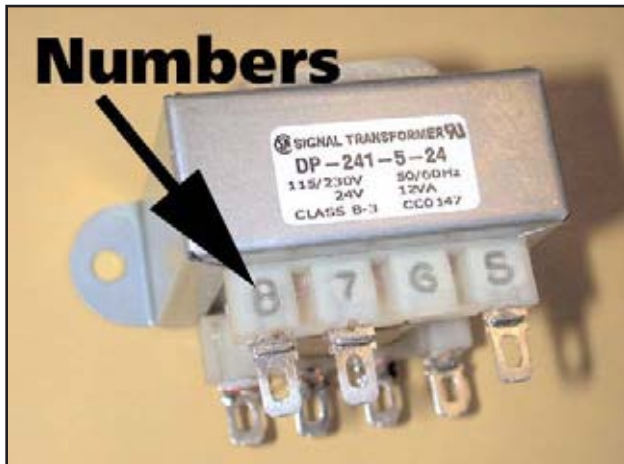

## WIRE HARNESES & BUSHINGS

### CONTROL WIRES

Wire harnesses can be provided by the factory. Contact factory for information.

## WIRE BUSHINGS

L-G-BUSH/EF .....\$2.25

**Heyco 3/4" Bushing.** These are the round plastic bushings that are press-fit into the element terminal box. The Power Element Lead Wires and Thermocouple Lead Wires come through these holes.

## CORD CLAMP

L-G-BSCD/EF .....\$5.00

**Plastic Cord Clamp for Easy-Fire.** This is the pressure clamp that holds the cord in place.

*Below is the L-G-BSCD/EF Cord Clamp:*



## COMPLETE CONTROL BOXES

The complete control boxes include power cord, all components (DynaTrol, Power relays, Control Transformer, Terminal Block and all wiring up to but not including the Terminal Strips.

L-E-2Z1P/EU .....\$650.00

**Complete Control Box for e18S-eu-230, e23S-eu-230 or e28S-eu-230 Single Phase.**

L-E-3Z1P/EU .....\$675.00

**Complete Control Box for e18T-eu-230, e23T-eu-230 or e28T-eu-230 Single Phase.**

L-E-3Z3P/EU .....\$700.00

**Complete Control Box for e18T-eu-415Y, e23T-eu-415Y or e28T-eu-415Y Three Phase.**

## WIRE & TERMINALS

These separate wire and terminals are for those who want to make their own wires. We normally recommend that you replace the entire harness when replacing wires.

### TERMINALS

You will need a good wire stripper and crimping tool to do any rewiring in your kiln (available from us or in your local hardware store). Be sure to get all the wire strands inside the terminal end. Never use aluminum wire in a kiln or to hook up a kiln. Aluminum wire will quickly oxidize - especially around heat - and cause a major problem with heat and potentially a fire.

# PARTS FOR YOUR L&L EASY-FIRE KILN (EUROPEAN VERSION)

**M-A-SPAD/MD** .....\$0.55  
**Female Slip On Wire Terminal (Insulated, Medium, 1/4" Tab).** This is used on the control boards, 1/2 amp fuse holders, toggle switches and relays. Up to 16-14 Awg wire. Blue Insulated. Female Slip On Terminal.



**M-A-SPAD/LG** .....\$0.55  
**Female Slip On Wire Terminal (Insulated, Large, 1/4" Tab).** This is used on the power wires. Up to 12-10 Awg wire. Yellow Insulated. Female Slip On Terminal.



**M-A-SPAD/SM** .....\$0.55  
**Female Slip On Wire Terminal (Insulated, Small, 3/16" tab)** This is used on the transformers. Up to 16-14 Awg wire,.187 (3/16" tab) Blue insulated. Also used on thermocouple wires.



**M-A-LUGX/50** .....\$2.40  
**Non-insulated Hi Temp Ring Terminal** for 6 Ga wire and 1/4" stud. Used on power cords.



**M-A-RING/00** .....\$0.55  
**Medium Ring Terminal Uninsulated** Up to 12-10 Awg wire, #10 Stud. uninsulated Used for ground wires and element power wire ends that go onto the element terminals. Also used on the Ground wire.



**M-A-RING/SM** .....\$0.55  
**Small Ring Terminal Insulated** Up to 16-14 Awg wire, #10 Stud. insulated . Blue. Used for ground wires in the control circuit.



## POWER WIRE

This wire is rated for 150 Deg C and is used to connect power from the Power Terminal Block to the Power Relays, and from there to the Power Terminal Strip and from there to the Element Connection Blocks.

- L-G-WR10/BL** (Price is per foot).....\$2.10  
**10 Gauge Wire, Black,** Tinned Copper Rated for 150 deg C
- L-G-WR10/WT** (Price is per foot).....\$2.10  
**10 Gauge Wire, White,** Tinned Copper Rated for 150 deg C
- L-G-WR10/GR** (Price is per foot) .....\$2.10  
**10 Gauge Wire, Green,** Tinned Copper Rated for 150 deg C

## CONTROL WIRE

This wire is rated for 105 Deg C and is used to connect all the control functions such as the connections between the outputs of the DynaTrol to the Power Relay coils and all the wires going into the Control Transformer.

- L-G-WR16/BL** (Price is per foot).....\$ .80  
**16 Gauge Wire, Black,** Tinned Copper Rated for 105 deg C
- L-G-WR16/WT** (Price is per foot).....\$ .80  
**16 Gauge Wire, White,** Tinned Copper Rated for 105 deg C
- L-G-WR16/GR** (Price is per foot) .....\$ .80  
**16 Gauge Wire, Green,** Tinned Copper Rated for 105 deg C
- L-G-WR16/GY** (Price is per foot) .....\$ .80  
**16 Gauge Wire, Gray,** Tinned Copper Rated for 105 deg C
- L-G-WR16/BU** (Price is per foot) .....\$ .80  
**16 Gauge Wire, Blue,** Tinned Copper Rated for 105 deg C
- L-G-WR16/NG** (Price is per foot) .....\$ .80  
**16 Gauge Wire, Orange,** Tinned Copper Rated for 105 deg C
- L-G-WR16/PL** (Price is per foot) .....\$ .80  
**16 Gauge Wire, Purple,** Tinned Copper Rated for 105 deg C
- L-G-WR16/BN** (Price is per foot) .....\$ .80  
**16 Gauge Wire, Brown,** Tinned Copper Rated for 105 deg C

## THERMOCOUPLE LEAD WIRE

**T-G-0000/EU** (per foot).....\$4.25  
**High Temp Thermocouple Lead Wire.** This is special high temperature lead wire. Has European color coding.

# PARTS FOR YOUR L&L EASY-FIRE KILN (EUROPEAN VERSION)

## CERAMIC ELEMENT HOLDERS

Hard ceramic element holders are one of the unique features that make L&L Kilns so long lasting and valuable. See our Troubleshooting Guide for details on replacement if ever necessary.

### ELEMENT HOLDER LENGTHS

Element Holders come in several different lengths. The following is a list of the various sizes as they are used in the different models.

**e18S-eu, e18T-eu** use one 76mm (3") holder and one 89mm (3-1/2") holder per brick per normal side. On the brick where the element connections come through there are two 66mm (2-1/2") holders per brick.

**e23S-eu, e23T-eu** use two 89mm (3-1/2") holders per brick per normal side. On the brick where the element connections come through there are two 76mm (3") holders per brick.

**e28S-eu, e28T-eu** use one 76mm (3") long holder and one 107mm (4-1/4") holder per brick per normal side. On the brick where the element connections come through there are two 76mm (3") holders per brick.

*Below is C-G-EH39/TN #542 element holder:*

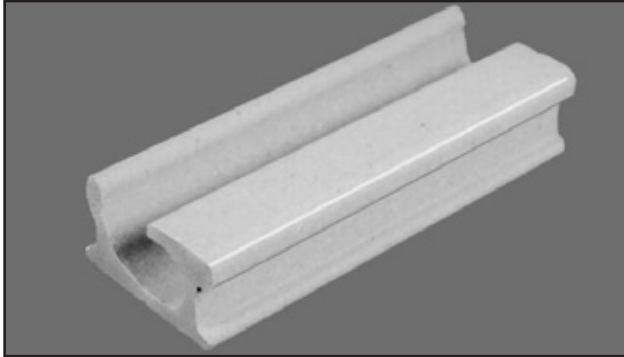

### ELEMENT HOLDER PRICES

|  |        |
|--|--------|
| C-G-EH15/TN .....                      | \$4.00 |
| 38mm (1-1/2") Long #542 Element Holder |        |
| C-G-EH25/TN .....                      | \$4.25 |
| 66mm (2-1/2") Long #542 Element Holder |        |
| C-G-EH30/TN .....                      | \$4.00 |
| 76mm (3") Long #542 Element Holder     |        |
| C-G-EH35/TN .....                      | \$4.00 |
| 89mm (3-1/2") Long #542 Element Holder |        |
| C-G-EH39/TN .....                      | \$4.25 |
| 3-15/16" Long #542A Element Holder     |        |
| C-G-EH4Q/TN .....                      | \$4.25 |
| 4-1/4" Long #542A Element Holder       |        |

## TOP & BOTTOM FIREBRICK SLABS

Tops and bottoms include stainless bands. Hinge parts and handle are not included.

### TOP FIREBRICK

|                              |          |
|------------------------------|----------|
| P-J-1803/TP .....            | \$135.00 |
| Top for a e18S-eu or e18T-eu |          |
| P-J-2303/TP .....            | \$170.00 |
| Top for a e23S-eu or e23T-eu |          |
| P-J-2903/TP .....            | \$250.00 |
| Top for a e28S-eu or e28T-eu |          |

### STAINLESS STEEL CLIPS

These are the thin stainless steel clips that get attached to the lid band and help hold the brick in place. Two are sandwiched together in each spot.

|  |        |
|--|--------|
| S-J-CLIP/18.....   | \$3.75 |
| Stainless steel angle clip used on e18S-eu, e18T-eu, e23S-eu and e23T-eu tops. |        |
| S-J-CLIP/29.....   | \$3.75 |
| Stainless steel angle clip used on e28S-eu and e28T-eu tops.                   |        |

*Below is shown a stainless steel angle clip used to hold firebrick into top band:*

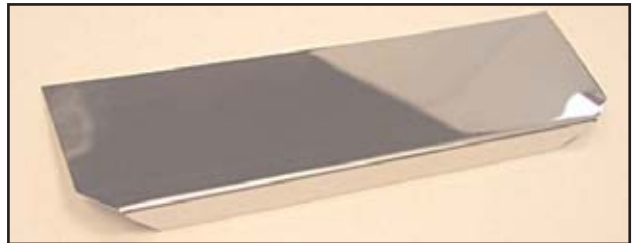

### BOTTOM FIREBRICK

*Below is shown a P-J-2903/BT bottom:*

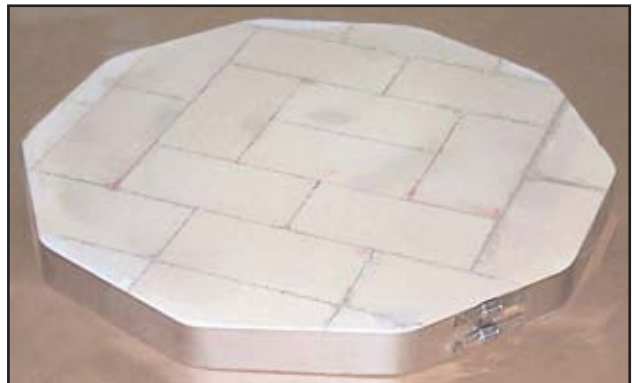

|                                 |          |
|---------------------------------|----------|
| P-J-1803/BT .....               | \$135.00 |
| Bottom for a e18S-eu or e18T-eu |          |
| P-J-2303/BT .....               | \$170.00 |
| Bottom for a e23S-eu or e23T-eu |          |
| P-J-2903/BT .....               | \$250.00 |
| Bottom for a e28S-eu or e28S-eu |          |

# PARTS FOR YOUR L&L EASY-FIRE KILN (EUROPEAN VERSION)

## **SIDE FIREBRICK - BRICKS & SECTIONS**

### **SINGLE SIDE BRICKS**

Sidebricks are single 228mm x 114mm x 76mm ( 9" x 4-1/2" x 3") bricks cut with the proper angles, relief cuts in the back and grooved for element holders. Each brick includes the appropriate element holders. If you need the brick where the elements go through the then specify that so that the proper element holders will be put in. The holes for the element connections must be drilled in the field.

*Below shows the inside of an e23T-eu kiln:*

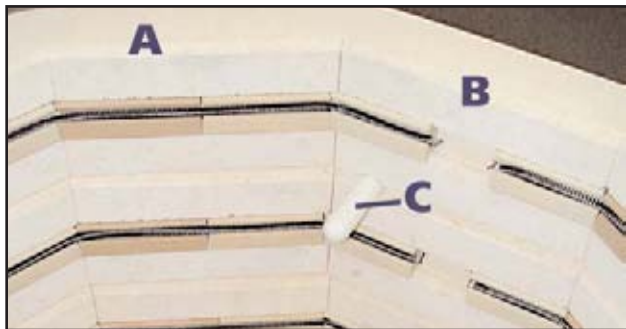

**A = Normal sidebrick**  
**B = Sidebrick for element connection side**  
**C = Thermocouple Protection Tube**

### **SIDEBRICK FOR e18S-eu & e18T-eu**

**F-E-1803/00.....\$18.00**  
**Sidebrick for e18S-eu & e18T-eu.** Includes a full line of ceramic element holders for the typical side.

**F-E-1803/EL.....\$18.00**  
**Sidebrick for element connection side for e18S-eu & e18T-eu.** Includes two short element holders with a gap in the middle for the special brick where the elements connections go through.

**F-E-1803/NH.....\$9.50**  
**Sidebrick for e18S-eu & e18T-eu.** (No Element Holders).

### **SIDEBRICK FOR e23S-eu & e23T-eu**

**F-E-2303/00.....\$18.00**  
**Sidebrick for e23S-eu & e23T-eu.** Includes a full line of ceramic element holders for the typical side.

**F-E-2303/EL.....\$18.00**  
**Sidebrick for element connection side for e23S-eu & e23T-eu.** Includes two short element holders with a gap in the middle for the special brick where the elements connections go through.

**F-E-2303/NH.....\$9.50**  
**Sidebrick for e23S-eu & e23T-eu.** (No Element Holders).

### **SIDEBRICK FOR e28S-eu & e28T-eu**

**F-E-2803/00.....\$18.00**  
**Sidebrick for e28S-eu & e28T-eu.** Includes a full line of ceramic element holders for the typical side.

**F-E-2803/EL.....\$18.00**  
**Sidebrick for element connection side for e28S-eu & e28T-eu.** Includes two short element holders with a gap in the middle for the special brick where the elements connections go through.

**F-E-2803/NH.....\$9.50**  
**Sidebrick for e28S-eu & e28T-eu.** (No element holders).

## **CEMENT & BRICK REPAIR**

### **CEMENT & BRICK FACING**

**M-G-0050/00.....\$8.00**  
**Hi-Temp Cement (1/2 pint).** This is Brick Cement is the actual cement we use to cement our tops and bottoms together.

**M-G-0050/PH.....\$16.00**  
**Special Phosphate Bonded Cement (1/2 pint).** This is a type of cement with extremely good bonding properties - perfect for repairs.

**M-G-F050/00.....\$8.00**  
**Facing (1/2 pint)** Facing is the special coating we formulate to harden and coat the firebrick.

**F-G-BRCK/30.....\$5.50**  
**228mm x 114mm x 76mm (3" x 4-1/2" x 9") UN CUT BRICK**

### **BRICK REPAIR KIT**

**M-G-BKIT/00.....\$27.00**  
**Brick Repair Kit.** This is a special kit which includes a 1/8 pint of very special phosphate bonded firebrick cement, 1 quart of firebrick dust, 1 small firebrick piece, 1/2 pint brick facing and detailed instructions. With this kit it is possible to repair many firebrick problems (such a gouges) to almost like new condition.

### **CERAMIC FIBER**

**F-G-FIBR/00.....\$16.00**  
**(per linear foot x 60cm 24" wide) Non-RCF ceramic fiber BLANKET.** This is a non-hazardous version of ceramic fiber. It is soluble in the human body (i.e. lungs). It will withstand about 1250 Deg C - beyond which it will shrink and/or melt. This is great for stuffing around thermocouple holes and general gasketing. One linear foot is 60cm (24") wide by 30cm (12") long by 2.5cm (1") thick.



# PARTS FOR YOUR L&L EASY-FIRE KILN (EUROPEAN VERSION)

## SCREWS, BOLTS, NUTS, WASHERS

NOTE: This is provided a a reference so you can see what hardware is used in the kiln.

### **SHEET METAL SCREWS**

**M-A-SMS2/00.....\$0.20**  
**#10 x 1/2" long Stainless Steel Sheet Metal Screw.** #10 X 1/2" Phillips Pan Head. This is the most common sheet metal screw used. It is used to attach the hinge parts to the kiln and lid and to attach the handles to the kiln sections and door. (54 used on a 3 section kiln, 46 used on a 2 section kiln)

**M-A-SMS3/00.....\$0.40**  
**#6 x 1-1/2" long Stainless Steel Sheet Metal Screw.** #6 X 1 1/2" Phillips Pan Head. These are used to attach thermocouples to the kiln and to attach Element Terminal Blocks to kiln. (12 used on a 3 section kiln, 8 used on a 2 section kiln)

**M-A-SMS6/00.....\$0.15**  
**#8-3/8" long Slot Head Pan Sheet Metal Screw.** This is used to attach the Control Box to the Element Cover Box. It is also used to attach Power Relays and Control Transformer to Contactor Panel. (10 used on 3 section kiln, 8 used on a 2 section kiln)

**M-A-SMS7/00.....\$0.15**  
**#8-3/4" long Slot Head Pan Sheet Metal Screw.** This is used to fasten Element Cover Box to the kiln. It is also used to attach Power Terminal Block to Contactor Panel. It is also used to attach the Power Terminal Strip and the Thermocouple Terminal Strip to the Element Cover Box. (12 used on a 3 section kiln, 10 used on a 2 section kiln)

**M-A-SMS5/00.....\$0.15**  
**#6-3/8" long Slot Head Pan Sheet Metal Screw.** This is used to fasten the DynaTrol to the front of the control box. (4 used)

### **#10 MACHINE SCREWS, NUTS, WASHERS**

**L-G-TERM/00.....\$0.55**  
**Stainless Steel Terminal Bolt, #10-24 x 1-1/4" long.** Used for all element connections. (2 per section)

**L-G-SNUT/00.....\$0.25**  
**#10-24 Stainless Steel Nut.** This is used on the element terminals and the vent bypass box. Also used to mount Contactor Plate to Control Box. (4 per vent, 3 per element terminal)

**L-G-WASH/00.....\$0.15**  
**#10 Stainless Steel Washer.** This is used on the element terminals. (3 per element terminal)

**L-G-LOCK/00.....\$0.15**  
**#10 Stainless Steel Lock Washer.** This is used on mounting the vent bypass box. Also used on the element terminals. (1 per element terminal)

**M-G-TSET/00.....\$3.45**  
**Element Board Terminal Set.** Price is for the whole set. Includes: One #10-24 SS bolt 1-1/4" long, One SS lock washer, Three #10-24 SS nuts, Four #10 SS flat washers.

### **1/4-20 MACHINE SCREWS, NUTS, WASHERS**

**M-A-MS45/00.....\$0.25**  
**#1/4-20 x 1/2" long Bolt.** This is used to attach the stand legs. (2 per leg, 8 per kiln)

**M-A-MNT4/00.....\$0.15**  
**#1/4-20 Nut.** This is used to attach the Vent Motor to the wall-mount bracket (4 per vent)

**M-A-MWS4/00.....\$0.10**  
**#1/4 Lock Washer.** This is used to attach the Vent Motor of the wall-mount bracket (4 per vent)

## ELEMENT COVER BOXES

Element cover boxes include insulation and plastic bushings installed. Does not include Power Terminal Strip and Thermocouple Terminal Strip.

**S-E-ECBX/02.....\$55.00**  
**Element Cover Box for e18S-eu, e23S-eu & e28S-eu**  
Includes four mounting screws. Aluminised steel. Includes insulation and plastic bushings installed. Does not include Power Terminal Strip and Thermocouple Terminal Strip.

**S-E-ECBX/03.....\$60.00**  
**Element Cover Box for e18T-eu, e23T-eu & e28T-eu.**  
Includes six mounting screws. Aluminised steel.

**S-E-ECBX/IN.....\$15.00**  
**Element Cover Box Insulation.** Holes are prepunched.

*Insulation inside an Element Cover Box:*



## CONTROL BOX

The metal box that houses the controls is the same for all Easy-Fire models. The contactor plate that holds the Power Relays, Control Transformer, and Power Terminal Block is also the same for all models.

**S-E-CTBX/EU.....\$60.00**  
**Control Box.** Includes six mounting screws. Aluminised steel.

**S-E-CTBX/PL.....\$25.00**  
**Component Plate.** Aluminised steel (See photo on page 2)

# PARTS FOR YOUR L&L EASY-FIRE KILN (EUROPEAN VERSION)

## EASY-LIFT SPRING HINGE

### SPRINGS FOR EASY-LIFT HINGE

There are three springs available for this hinge system. They each have a different force. Springs force can also vary from spring to spring. If you are getting too much or too little force for your personal preference you may want to try one of the other springs. The hinge for the e18S-eu and e18T-eu is not spring-loaded.

**S-G-SPRG/23 .....\$25.00**  
**Spring for e23S-eu and e23T-eu.** Color coded on one end: RED.

**S-G-SPRG/2X .....\$25.00**  
**Spring for e28S-eu & e28T-eu.** Color coded on one end: GREEN.

### HINGE BARS FOR EASY-LIFT

**S-G-PINX/00.....\$9.50**  
**Replacement Hinge Bar-Pin for Easy-Lift.** Includes two cotter pins. This is chrome plated. It is 29cm (11-1/2") long.

**S-G-COTT/00 .....\$1.25**  
**Cotter Pins** (two in a set). Price is for two.

*Below is the S-G-PINX/00 hinge bar:*



### MISCELLANEOUS PARTS

**S-G-HPIN/00 .....\$20.00**  
**Locking Push Pin** for holding door in position with SS wire rope and mounting bracket. The push pin has a spring-loaded plunger that holds it securely in the hole of the hinge body.

*Below is the S-G-HPIN/00 Push Pin Assembly:*



**S-G-TOOL/00 .....\$20.00**  
**Installation Tool for spring.** This is a long machined bar designed to help install the hinge system. There is a notched end that allows you to grab the spring and exert force with the leverage of the long bar. THIS IS A MAJOR AID FOR INSTALLING HINGE SPRING.

### COMPLETE REPLACEMENT HINGES

**S-G-HGEL/23 .....\$185.00**  
**Complete Replacement Hinge for e23S-eu, e23T-eu.** Includes spring, hinge bar and mounting hardware.

**S-G-HGEL/29 .....\$210.00**  
**Complete Replacement Hinge for e28S-eu, e28T-eu.** Includes spring, hinge bar and mounting hardware.

*Below is an "Easy-Lift, Easy-Load" hinge on an e23T. Some of parts are identified.*

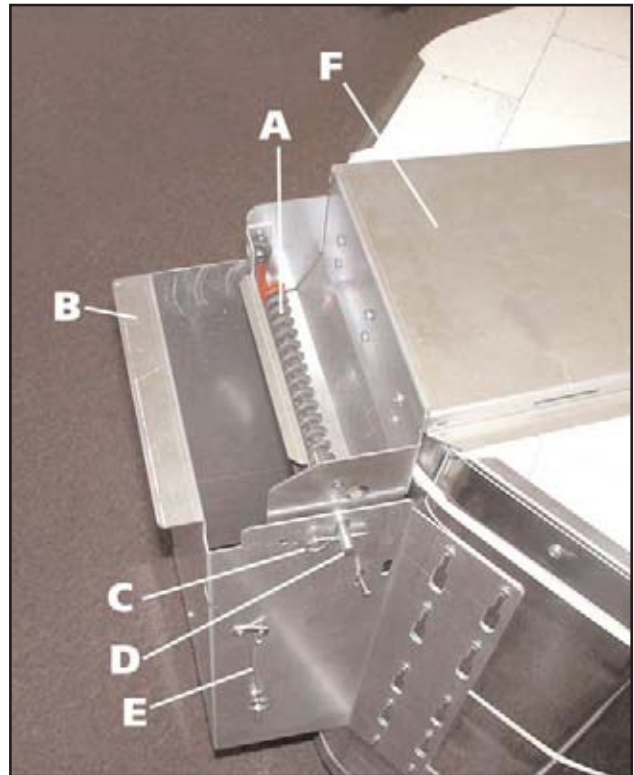

**A= S-G-SPRG/23 Spring**  
**B = Hinge body - part of S-G-HGEL/23**  
**C = S-G-COTT/00 Cotter pin**  
**D = S-G-PINX/00 Hinge bar**  
**E = S-G-HPIN/00 Locking Push Pin**  
**F = Top Hinge Piece - part of S-G-HGEL/23**

*Below is the S-G-HPIN/00 Push Pin Assembly:*

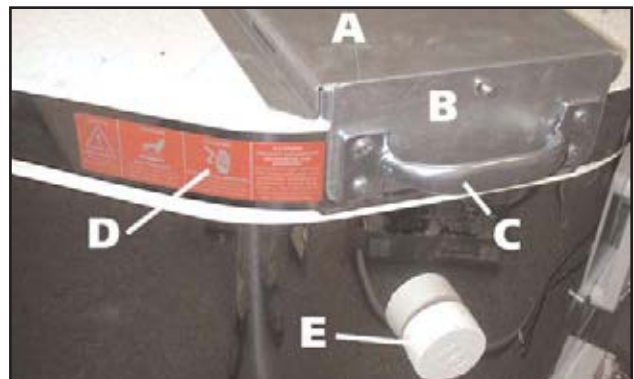

**A= Top Hinge Piece - part of S-G-HGEL/23**  
**B = Front Hinge Piece - part of S-G-HGEL/23**  
**C = M-G-HNDD/00 Handle**  
**D = M-L-HOTD/00 Warning Hot Label**  
**E = C-G-PEEP/00 Peephole Plug**

# PARTS FOR YOUR L&L EASY-FIRE KILN (EUROPEAN VERSION)

## NON-SPRING HINGE FOR e18

### DOOR CHAIN SYSTEM

M-G-CNDR/EU (Price per cut chain) .....\$3.50

**Door Chain (#8)** This is the chain that attaches the door to the kiln.

*Below is the M-G-CNDR/00 chain :*



S-G-HNGE/00.....\$75.00

**Complete SS Standard Hinge for e18S-eu & e18T-eu.**

Includes the parts that attach to the kiln, the part that attaches to the lid and the hinge bar and attachment hardware and screws. This is the standard hinge. This hinge is made from 14 gauge stainless steel and is a much heavier-duty hinge than we used to use.

*Below is a S-G-HING/00 complete hinge assembly:*



S-G-PINX/SM .....\$9.50  
**Hinge Bar for for Standard Hinge**

S-G-COTT/00 .....\$1.25  
**Cotter Pins (two in a set).** Price is for two.

## STANDS

The kiln stands are made of aluminised steel which resist corrosion even at the high temperatures experienced on the stands. The design of the legs is very sturdy with several stiffening bends. The top of all the stands is a sheet of aluminised steel with two bends on the sides for great structural strength. This will provide good support for the entire brick bottom. All stands have a 76mm (3") diameter hole in the center and four studs welded which our vent collection box attaches to. All stands are 20cm (8") inches high. When you order a stand you will get the stand top, legs plastic feet and appropriate hardware set all included.

A-J-1800/00.....\$55.00  
**Heavy Gauge (14 Ga) Aluminised Steel Stand For e18S, e18T.** 30cm (15") square by 20cm (8" high)

A-J-2300/00.....\$60.00  
**Heavy Gauge (14 Ga) Aluminised Steel Stand For e23S, e23T.** 48cm (19") square by 20cm (8" high)

A-J-2900/00.....\$75.00  
**Heavy Gauge (14 Ga) Aluminised Steel Stand For e28S, e28T.** 66cm (26") square by 20cm (8" high)

A-J-FOOT/00.....\$2.25  
**Plastic Foot for stand legs**

A-J-LEGP/00.....\$6.00  
**Stand leg with threaded fastener pressed into metal.**

A-J-HARD/PM.....\$4.25  
**Hardware for attaching legs.** Includes (8) bolts.

*Below is an assembled stand:*



# PARTS FOR YOUR L&L EASY-FIRE KILN (EUROPEAN VERSION)

Below shows the A-J-FOOT/00 Plastic Foot for the stands:



**WARNING ABOUT STAND INSTALLATION:** It is critical to level stand when installing it. The stand **MUST NOT** rock at all. Also the bottom of the kiln **MUST NOT** rock when placed on the stand. If it does there is a high likelihood that the floor of the kiln could crack.

## MISC HARDWARE

---

### HANDLES

M-G-HNDD/00 .....\$8.50

Lid Handle. Zinc plated.

Below is the M-G-HNDD/00 handle:



### CASE HANDLES

M-G-HNDL/00 .....\$13.00

3-1/2" Chest Handle. Plated. Includes four mounting screws.

Below is the M-G-HNDL/00 door handle:





# TROUBLESHOOTING & FIXING EASY-FIRE KILN (EUROPEAN VERSION)

## TABLE OF CONTENTS

|   |          |
|---|----------|
| <b>TABLE OF CONTENTS</b> .....  | <b>1</b> |
| <b>EASY-TO-USE TROUBLESHOOTING GUIDE</b> .....                                  | <b>3</b> |
| <b>DISPLAY DOESN'T SHOW ANYTHING</b> .....                                      | <b>3</b> |
| On/Off Switch .....   | 3        |
| Fuse .....  | 3        |
| Plug & Cord .....   | 3        |
| Circuit Breaker / Power Source .....  | 4        |
| Internal Wiring .....   | 4        |
| Short Circuits .....  | 4        |
| Control Transformer .....   | 5        |
| Control Board .....   | 5        |
| <b>DISPLAY READS FAIL</b> .....   | <b>5</b> |
| <b>DISPLAY READS UNUSUALLY HIGH TEMPERATURE or CPLt WHEN IT STARTS UP</b> ..... | <b>6</b> |
| <b>DISPLAY IS NORMAL BUT KILN WON'T HEAT UP</b> .....                           | <b>6</b> |
| Programming & Operation .....   | 6        |
| Wiring .....  | 6        |
| Control Board Outputs .....   | 7        |
| Bad Power Relays .....  | 7        |
| Bad Elements .....  | 7        |
| <b>KILN FIRES UNEVENLY</b> .....  | <b>7</b> |
| Peepholes and Vents .....   | 7        |
| Lid Seal .....  | 7        |
| Elements .....  | 7        |
| Loading .....   | 8        |
| Firing with Cones .....   | 8        |
| Thermocouple Offsets .....  | 8        |
| Vent System (Optional) .....  | 8        |
| LAG & AUTOLAG SETTINGS .....  | 8        |
| <b>KILN FIRES TOO HOT OR COLD</b> .....   | <b>9</b> |
| Firing with Cones .....   | 9        |
| Easy-Fire vs Vary-Fire .....  | 9        |
| Hold Times .....  | 9        |
| Control Settings .....  | 9        |
| Thermocouple Drift .....  | 9        |
| <b>KILN STALLS</b> .....  | <b>9</b> |
| <b>KILN FIRES SLOWLY</b> .....  | <b>9</b> |
| Bad or Wrong Voltage .....  | 9        |
| Element Aging .....   | 10       |
| Power Relays .....  | 10       |
| Bad Wiring .....  | 10       |
| Wiring in the Kiln .....  | 11       |
| Element Connections .....   | 11       |
| Heat Leakage & Vents .....  | 12       |
| Single vs Three Zone Control .....  | 12       |
| LAG Setting .....   | 13       |
| Autolag Setting .....   | 13       |
| ShtO (Shut-Off) Setting .....   | 13       |

|   |           |
|---|-----------|
| PId Setting .....   | 13        |
| Adding More Insulation .....  | 14        |
| <b>KILN HEATS TOO FAST</b> .....                                      | <b>14</b> |
| Voltage .....   | 14        |
| Elements .....  | 14        |
| <b>ERROR MESSAGES</b> .....   | <b>15</b> |
| Errd .....  | 15        |
| Err1 .....  | 15        |
| Err2 .....  | 16        |
| Err3 .....  | 16        |
| Err4 .....  | 16        |
| Err5 .....  | 16        |
| Err6 .....  | 16        |
| Err7 .....  | 16        |
| Err8 .....  | 16        |
| ErrP .....  | 16        |
| Err- .....  | 16        |
| ErrE .....  | 17        |
| FAIL .....  | 17        |
| Turning Error Codes On or Off .....                                   | 17        |
| Can you restart the kiln after it stops because of Error Codes? ..... | 18        |
| <b>REMOVING PANEL FOR SERVICE</b> .....                               | <b>18</b> |
| <b>REPLACING DYNATROL</b> .....                                       | <b>18</b> |
| <b>REPLACING TRANSFORMER</b> .....                                    | <b>19</b> |
| <b>REPLACING POWER RELAYS</b> .....                                   | <b>19</b> |
| <b>REPLACING FUSE HOLDER</b> .....                                    | <b>19</b> |
| <b>REPLACING ELEMENT SHUTOFF SWITCH</b> .....                         | <b>20</b> |
| <b>REPLACING THERMOCOUPLES</b> .....                                  | <b>20</b> |
| <b>REPLACING ELEMENTS</b> .....                                       | <b>21</b> |
| <b>REPLACING ELEMENT HOLDERS</b> .....                                | <b>23</b> |
| Method #1 .....   | 23        |
| Method #2 .....   | 24        |
| <b>CRACKS IN THE LID &amp; BOTTOM</b> .....                           | <b>24</b> |
| <b>TIGHTENING STAINLESS BANDS</b> .....                               | <b>25</b> |
| <b>REPLACING FIREBRICK IN SIDES</b> .....                             | <b>25</b> |
| <b>DRILLING OUT HOLES FOR PEEPHOLES</b> .....                         | <b>26</b> |
| <b>DRILLING OUT FOR THE ELEMENT CONNECTIONS</b> .....                 | <b>26</b> |
| <b>REPLACING BOTTOMS</b> .....  | <b>26</b> |
| <b>REPLACING LIDS</b> .....   | <b>26</b> |
| <b>CHECKING ELEMENT OHMS</b> .....                                    | <b>27</b> |

# TROUBLESHOOTING & FIXING EASY-FIRE KILN (EUROPEAN VERSION)

Photo of a single phase control panel for a 3 section e18T,e23T-eu or e28T-eu

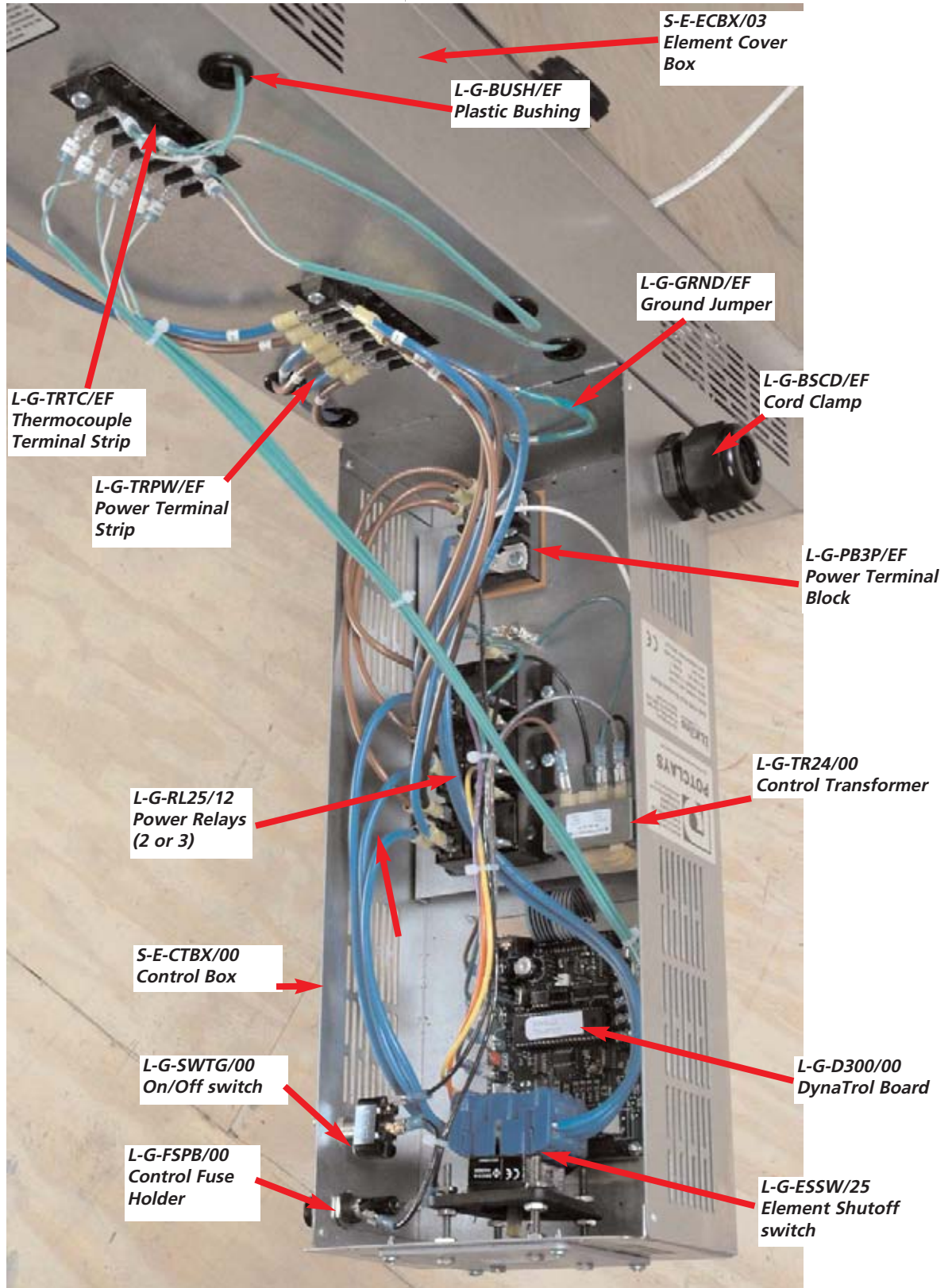

# TROUBLESHOOTING & FIXING EASY-FIRE KILN (EUROPEAN VERSION)

## **CAUTION - ELECTRICITY CAN KILL**

Many of the tests described in here are performed under power. They should be done **ONLY** by someone who is familiar with electrical safety such as an electrician or trained maintenance person. We identify any test that is live with a **CAUTION** statement. We describe these tests in detail so that an electrically trained person who doesn't specifically understand kilns can do the troubleshooting - the level of simplicity described is not meant as an invitation to harm the untrained. **AS LONG AS THE KILN IS UNPLUGGED OR THE CIRCUIT BREAKER IS TURNED OFF YOU ARE SAFE. TEST TO BE SURE.**

## **GET A DIGITAL MULTIMETER!**

We recommend the purchase of a digital electrical multi-meter. Without it you are only guessing at the origin and severity of an electrical problem based on how the kiln is acting. Be forewarned however: Testing electrical circuits is very dangerous and potentially deadly if you do it incorrectly. It could result in electrocution! If you don't feel comfortable doing this hire an electrician or get someone to do it who is qualified. That being said - many of the tests described in here just require testing for resistance - which is done with the kiln unplugged. **AS LONG AS THE KILN IS UNPLUGGED OR THE CIRCUIT BREAKER IS TURNED OFF YOU ARE SAFE. TEST TO BE SURE.**

## **AN EASY-TO-USE TROUBLESHOOTING GUIDE**

This troubleshooting guide is written specifically for the European CE certified Easy-Fire kilns. We have tried to thoroughly illustrate it to guide you through step-by-step to solve most of the potential problems you might encounter. It is organized by symptom and potential causes and solutions. There are two major sections. The first section tells you how to diagnose the problem. The second section provides detailed explanations on how to change components and fix various problems.

## **CONTROL DISPLAY DOESN'T SHOW ANYTHING**

### **On/Off Switch**

1) Make sure the On/Off Switch is turned on. Turn it on and off.

### **Fuse**

2) Check control fuse in side of control box. Twist open the fuse holder and physically check the little fuse. You can see if the metal element inside is melted if it is blown. You can also use your digital multi-meter to check continuity across the fuse.

*Picture of the on/off switch and fuse holder opened.*



### **Plug & Cord**

1) Make sure the power cord is plugged into the receptical(if you have a plug). Reseat plug. Make sure it is held firmly and that the springs inside the receptical seem to be working.

2) With power off examine the electrical cord or connecting cable. Look for burned or melted areas



# TROUBLESHOOTING & FIXING EASY-FIRE KILN (EUROPEAN VERSION)

and breaks or pinched sections. Look closely at the head of the plug. Look for oxidation or substantial discoloration or even burnt spots on the prongs. Replace plug and cord if this is questionable.

3) With power turned on and panel open check voltage at the Power Terminal Block. If you see no voltage there then you know something is wrong with the power source. **CAUTION: This test should only be done by an experienced person familiar with electricity and its dangers.**

*Checking voltage at the Power Terminal Block:*



## **Circuit Breaker / Power Source**

1) Check voltage at the receptical. **CAUTION: This test should only be done by an experienced person familiar with electricity and its dangers.**

*A Fused Disconnect Switch:*



2) Check circuit breaker or fused disconnect switch to make sure they are turned on. Sometimes circuit breakers need to be turned on and off to reset them.

3) If you have a fused disconnect check the fuses with

your voltmeter for continuity. **CAUTION: This test should only be done by an experienced person familiar with electricity and its dangers.**

4) Make sure fuses or circuit breaker is the proper amperage and type. See wiring diagram for details.

5) Test for voltage at the main power supply as close to the kiln as possible. **CAUTION: This test should only be done by an experienced person familiar with electricity and its dangers.**

## **Internal Wiring**

1) Unplug kiln or turn off at circuit breaker or fused disconnect and open up panel. **CHECK VOLTAGE TO BE SURE THERE IS NO LIVE POWER TO THE KILN.** Make sure that all the wires inside the control panel are connected. See photograph on page 2 and also the Wiring Diagram. Specifically look at the wires that go from the power connection block to the on/off switch, then to the control fuse and then to the control transformer.

## **Short Circuits**

**Do all the following with the kiln unplugged.**

1) Check for short circuits. Look for any signs of burnt wires. This might indicate a short circuit. A way this might happen, as an example, is that frayed wires at the end of a wire connector might touch each other.

2) Check for worn wires that may have shorted against the case. Examine wire insulation. If the wire insulation has become frayed the wires could short to the metal casing which is electrically grounded.

3) Look for dirt. Some dirt (such as carbon compounds) are electrically conductive. This is generally not the case with ceramic materials but some can be. Vacuum out if you see dirt.

NOTE: Usually a short circuit will trip the circuit breaker for the kiln or the fuses in the fused disconnect switch if you have one. You will then not see any display on the DynaTrol. Turn your circuit breaker on and off and check fuses on the fused disconnect and control fuse.

# TROUBLESHOOTING & FIXING EASY-FIRE KILN (EUROPEAN VERSION)

## Control Transformer

**CAUTION:** These tests should only be done by an experienced person familiar with electricity and its dangers.

1) If none of these solve the problem then you could have a bad control transformer. To check the transformer operation test with your digital multimeter. It should read 220 to 240 volts across terminals 4 & 7 (where the White and Green-Yellow wires come into it) and 24 volts across terminals 5 & 8 (where the Gray and Brown wires come out). This is a live test so be very careful not to touch any of the wires - **remember there is high voltage in the panel and this can electrocute you.** See photo below. If you are not getting proper voltage (or any voltage from the transformer and you are getting it to the transformer then you need to replace the transformer.

*Checking output of the Control Transformer (DANGER-live test:*

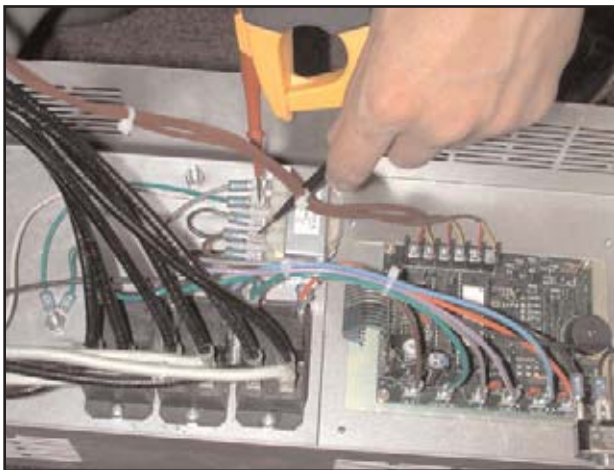

2) If there is 220 to 240 volts coming into the control transformer (terminals 4 & 7, White & Green-Yellow wires) and there is no voltage coming from the transformer (across terminals 5 & 8, Gray & Brown) then you have a bad control transformer and it needs to be replaced.

3) If there is no voltage coming into terminals 4 & 7 (where the White and Green-Yellow wires come in), then test for it at the Power Terminal Block where the power cord comes in. If there is power there then look for a bad connection or wire between the power connection block and the transformer, i.e. a bad toggle switch, wire, or ½ amp fuse holder. If power is not

there then go further back on the line and measure the voltage. Keep going until you find voltage, then look for the problem between that point with the voltage and the last point checked that had no voltage.

## Control Board

1) If the transformer is OK and you know you have voltage going to the control board but the control still shows no display then the control board needs to be replaced.

## DISPLAY READS FAIL

1) Usually **FAIL** will be seen flashing along with a **tC1**, **tC2** or **tC3** indicating which thermocouple has failed.

2) Unplug the kiln or turn off disconnect switch (**and check to make sure there is no live power to the kiln**). Open the Control Panel. Remove the appropriate (tC1, tC2 or tC3) thermocouple connection wires from the Thermocouple Terminal Strip and bind the green and white wires together (so they connect with each other. You can use electrical tape to do this - just make sure the metal terminal touch each other). Close up the panel and plug in the kiln. The control should read room temperature for that thermocouple (actually about 10°C above room temperature because of the thermocouple offsets).

3) If it does read room temperature then the thermocouple is probably bad and needs to be replaced. If the control does not read room temperature then there is either a bad thermocouple wire in the Control Thermocouple Harness or the control is bad.

4) Redo the test by putting a small jumper like a paperclip across the thermocouple terminals directly on the Dynatrol board. If the control now will read room temperature then you have a bad thermocouple wire. If it does not read room temperature then the control is definitely bad and needs to be replaced.

# TROUBLESHOOTING & FIXING EASY-FIRE KILN (EUROPEAN VERSION)

## DISPLAY READS UNUSUALLY HIGH TEMPERATURE or CPLt WHEN IT STARTS UP

Even though you know the kiln is not that hot. This indicates thermocouple circuit failure.

**TECHNICAL NOTE:** This is called thermocouple upscale protection. If the control senses a lack of millivoltage (an open circuit) it interprets this as the highest temperature the control could reach. This automatically ensures that the control will not call for power.

1) Check thermocouple end. Examine end carefully. Sometimes there can be a crack that opens up while the kiln is hot but appears to be normal when the kiln is cold. If the end of the thermocouple looks severely corroded and you are getting Error codes then it is best to replace the thermocouple. NOTE: You have to open up the Element Cover Box and remove the thermocouples to check the ends.

*A thermocouple end that will still work but is getting close to creating a problem:*



2) Check thermocouple circuit. For instance check to make sure that all the thermocouple lead wires are firmly connected to the Thermocouple Terminal Strip. Check where the thermocouple lead wires go into the ends of the thermocouples. Are the wires loose? Tighten the screws on the ends of the thermocouples to be sure you have a tight connection. Check for corrosion. Check where the thermocouples connect to the Dynatrol. Try pulling off each connection and reseating it. This can scrape away corrosion that may have built up. Check for melted wires inside the Element Cover Box.

3) A very easy check is to check resistance (ohms)

right on the Thermocouple Terminal Strip. Unplug kiln or disconnect from live power by turning off circuit breaker or fused disconnect switch. Open panel. You don't even have to remove the thermocouple wires. Just touch the terminal strip itself with your probes (terminals #1 & #2 for TC1, terminals #3 & #4 for TC2 and terminals #5 & #6 for TC3). If the thermocouples and circuit is normal then you will see a resistance of about .9 or 1.0. If you see an **OL** in your meter then you have an open circuit somewhere which is probably a bad thermocouple.

4) If you have a bad thermocouple replace it with a new one.

## DISPLAY IS NORMAL BUT KILN WON'T HEAT UP

### Programming & Operation

1) Make sure you have turned the element shutoff latch on.

2) Make sure you have programmed the kiln properly and it is supposed to be firing. Do you have a **Delay Time** or a **Preheat Time** in your program? (Hit **Review Prog** button to find out).

### Wiring

1) Unplug kiln or disconnect from live power by turning off circuit breaker or fused disconnect switch. Open panel. Check all power wires for firm connections. Using your multimeter set on resistance you can check continuity of each element circuit by pacing the probes on each set of outputs on each Power Relay or right at the Power Terminal Strip (as shown below).

*Testing for continuity in an element circuit.*





# TROUBLESHOOTING & FIXING

## EASY-FIRE KILN (EUROPEAN VERSION)

2) Visually inspect the power wires coming from the Power Terminal Block to the inputs of the Power Relays. Reseat all the spade connectors to rub off any oxides and to ensure a good connection.

### Control Board Outputs

1) It is possible that the the internal switches on the control board could be bad. You can test that by checking to see if you find voltage (12 volts DC) between any of the output contacts on the control board (where the orange, yellow and purple wires come out) to ground (any green-yellow wire). **CAUTION: This test should only be done by an experienced person familiar with electricity and its dangers.**

### Bad Power Relays

1) You should be able to hear contactors going on and off with a soft clicking noise when you first turn on the kiln and it is supposed to be heating up. If not try turning the kiln off and then back on again and restarting the program. Of course if you don't hear the relays it only tells you that they aren't firing. The problem could be in the control for instance not telling the relays to fire. If you do hear relays and the kiln is not heating then you know the problem is in the power circuit AFTER the relays.

2) With power on and panel open check voltage before and after each of the contactors while the kiln is firing. **CAUTION: This test should only be done by an experienced person familiar with electricity and its dangers.**

### Bad Elements

See next section.

## KILN FIRES UNEVENLY

### Peepholes and Vents

1) Plug up Peephole and Vent holes in the kiln to prevent drafts.

### Lid Seal

1) Check to make sure that door/lid is sealing properly. If door/lid is not sealing against top brick correctly a bright red glow will be visible around the

door/lid seal when kiln is operating. (A little of this is OK). Also excessive heat loss can be felt around seal. Rub seal high points down with sandpaper until no more than 1.5mm (1/16") gap is found at any point along seal. Note that the gap at the top will definitely appear larger than any gap you see between the kiln sections. This is partly because the lid actually bows down in the center of the lid when it heats up and the edges consequently rise slightly. Just check for an UNEVENNESS in this gap which will cause an excessive heat loss.

2) If door/lid is excessively cracked or worn or has holes in it this may cause drafts in the kiln. Replace lid.

*This shows a crack in a lid that is OK. Cracks are a natural event with refractory slabs. As long as the crack does not create a large pathway for heat to escape and remains stable it is OK to leave as it. See the section in the back called CRACKS IN THE TOP & BOTTOM:*



### Elements

1) Elements may have changed in resistance which will also have an effect on uniformity. (They don't always age at the same rate because some elements get more use than others). The three zone control mostly compensates for this but there are limits to this compensation. Check element resistance (see section at end of Troubleshooting Guide called "CHECKING ELEMENT OHMS").

2) Empty the kiln. Then turn kiln on using a fast program like FAST GLAZE until elements are red. Open the door carefully and observe the elements to see if they all seem to be glowing about the same amount. **CAUTION: The power does not turn off when you open the lid. Be careful not to put your**

# TROUBLESHOOTING & FIXING

## EASY-FIRE KILN (EUROPEAN VERSION)

**hand inside the kiln while it is on. Dangerous electric shock could result if you touch an element.**

3) There is a good diagnostic program within the Dynatrol. This is handy to use when your kiln is first delivered and set up to make sure it was done properly. It can also be useful in seeing if an element has burned out. To use this diagnostic program enter the following sequence when the display says **IdIE**.

a) Press **OTHER, 4, 4, 3**

b) Keep pressing **OTHER** to cycle through the menu options until you get to **dIAG** and then press **ENTER**.

c) Open the lid of your kiln. You will see each zone of the kiln turn on for one minute each, starting with zone #1, the top zone. The control will display **OUt1**, then **OUt2**, then **OUt3** as it cycles through this sequence. This will tell you if the kiln sections are in the wrong order or if the wires are somehow crossed in the control panel. If this is the case the zones will not turn on in the proper 1, 2, 3, order.

**NOTE:** To run this diagnostic test you will have to open and close the lid several times because of the element shutoff switch.

### Loading

1) The Dynamic Zone Control of the EASY-FIRE kilns can compensate for many uneven loading situations. However, if you are having a problem with uneven firing try to vary the way you load it to match the firing characteristics of the kiln. For instance if it typically fires hot at the top then put more weight in the top to absorb that heat.

2) Be sure to put posts under the bottom shelf. The bottom shelf should be at least 10mm to 40mm (1/2" to 1-1/2") above the floor of the kiln.

3) Run an empty kiln with three cone packs top-middle - bottom. This will tell you if the load contributes to the problem.

### Firing with Cones

1) Try using cone packs in all sections (top, center, bottom) of the kiln and keep records of what happens. See *troubleshoot-cones.pdf* in the LOG, CONES,

TIPS section of your Instruction Manual.

### Thermocouple Offsets

Thermocouples can drift in their accuracy over time and this can happen at different rates for each thermocouple. If one thermocouple reads at a different temperature than another thermocouple this can cause UNEVENNESS in the kiln. You may need to adjust the offsets to trick the kiln into firing hotter or cooler in certain zones. Read about Thermocouple Offset in section 4.3.1.8 in the DynaTrol Reference Manual (*dynatrol-instruct-blue.pdf* in the DYNATROL reference section).

### Vent System (Optional)

1) Is your vent system on and pulling air? You can check this with a source of smoke in a cold kiln. (If you burn a small piece of paper near the holes on the bottom of the kiln with the vent on and THE KILN OFF you can see if the smoke is being drawn into the holes. You can also check this by feeling the output of the vent when the kiln is at high temperatures. The air coming out should be quite warm to the touch (about 40°C to 60°C - 110°F to 140°F). The Vent-Sure will aid in keeping your kiln uniform by drawing hot air from the top of the kiln towards the bottom. It counteracts the natural rising of the heat. If you want to increase draw first close the Bypass valve on the Bypass Collection Box under the kiln. You can also increase the size of the vent holes in the bottom of the kiln. You can also try taking out the top peephole plug. See the separate Vent-Sure instruction manual.

### LAG & AUTOLAG SETTINGS

Check the LAG setting (see information in these instructions under "KILN FIRES SLOWLY"). To get the kiln to fire more evenly you may want to decrease the LAG setting and perhaps turn the AUTOLAG OFF.



# TROUBLESHOOTING & FIXING

## EASY-FIRE KILN (EUROPEAN VERSION)

### **KILN FIRES TOO HOT OR COLD**

#### **Firing with Cones**

1) Try using cone packs in all sections (top, center, bottom) of the kiln and keep records of what happens. See *troubleshoot-cones.pdf* in the LOG, CONES, TIPS section.

#### **Easy-Fire vs Vary-Fire**

Keep in mind that the Easy-Fire programs feature Orton software that adjusts the final temperature based on the speed of firing. This in effect adjusts the heat-work and hence the actual cone that the kiln fires to. This feature is not in the Vary-Fire programs. You have to input the final set point temperature in a Vary-Fire program.

#### **Hold Times**

Be very careful with hold times. Even a fairly short hold time of 10 minutes can dramatically increase the amount of "heat-work" and hence the cone that the kiln fires to. On the other hand you can use the hold time to increase the heat-work to compensate for underfired work. Just test this in small increments (like 5 or 10 minute soak times). There is a great program available for free from Orton's web site that allows you to calculate this with some precision. This is the Cone Calculation Program found at <http://www.ortonceramic.com> (under Resources).

#### **Control Settings**

1) The ceramic thermocouple protection tubes introduce a known error into the system. The temperature that is measured by the tip of the thermocouple is approximately 10 Deg C cooler than the actual kiln temperature. We preprogram a 10 Deg C offset into the control on each thermocouple offset setting. (The setting is **0010**) (There is also a cone offset for cones 022 to 017).

#### **Thermocouple Drift**

Thermocouples drift in their accuracy with time. You may have to make further adjustments in the Thermocouple Offset or Cone Offset settings over time.

### **KILN STALLS**

1) If for some reason the thermocouple wires touch the hot kiln case they may melt and fail. The result of this is that the kiln can "stall out", say **CPLt** prematurely or display any other number of other random error codes. It may refuse to increase in temperature, and the kiln will just run on and on. If it is re-started it may work fine for a while. What happens is that the millivolt signal in the TC wire goes to ground, or the two wires in the TC wire are 'electrically' connected by the stainless steel melting through the insulation and the 'temperature' is then taken right there, not in the kiln. However, the signal received can be so foreign to the microprocessor that the kiln will just stall. The specific Thermocouple Lead Harness needs to be replaced.

2) Thermocouples close to end of their useful life can cause some of these same problems.

3) Sometimes excessive ambient temperatures (over 50°C / 125°F) around the control can cause stalling too.

4) Corroded connection points can also cause stalling.

### **KILN FIRES SLOWLY**

#### **Bad or Wrong Voltage**

1) Check your voltage. Do this at the kiln at the Power Terminal Block with the control panel open or check it at your fused disconnect box. **CAUTION: This test should only be done by an experienced person familiar with electricity and its dangers. You need to see what the voltage is when the kiln is firing.**

Low voltage will make the kiln fire considerably slower. Check voltage at your panel and where the kiln is connected. Check the voltage when the kiln is firing and when it is not firing. Sometimes the high amperage draw of the kiln will cause a voltage drop at the kiln. A voltage drop of 5 to 10 volts is not uncommon and is to be expected. If your voltage drop is more than that then you may have a problem with your electrical supply.

2) Make sure no other large electrical appliances such as a clothes dryer or electric oven are on when you are operating your kiln. This may cause a voltage drop

## TROUBLESHOOTING & FIXING EASY-FIRE KILN (EUROPEAN VERSION)

which would slow the kiln down.

3) Voltage may vary in your area depending on season and time of day. Frequently there are "brown outs" during the summer months in some areas. This is when the electric utility reduces the voltage. Try firing at night after peak electrical use hours. You can use your Delay feature to do this easily. Find out from your local utility company when the end of the peak period of electrical use is. Some utilities offer preferential rates for using electricity at night because it is cheaper for them.

### Element Aging

1) Elements age when fired and the elements increase in resistance. When they increase in resistance the amount of power they develop decreases. See the section on "CHECKING ELEMENT RESISTANCE" at end of this guide.

2) Replacing only one element per zone may cause an unbalance in firing. However, our multi-zone control will compensate for much of this imbalance automatically.

3) Empty the kiln. Then turn kiln on until elements are red. Open the door carefully and observe the elements to see if they all seem to be glowing about the same amount. CAUTION: The power does not turn off when you open the lid. Be careful not to put your hand inside the kiln while it is on. Dangerous electric shock could result. See the diagnostic program described in the earlier section called KILN FIRES UNEVENLY.

4) Elements expand and grow with age. If you fire low-fire clay and glazes and never get above cone 05 or so (1031°C), your elements will last a long time, especially if you are only bisque firing. This is good, to a point. If you only low-fire, the problem you are most likely to encounter over many years is that the elements will expand as they age. The length and the coil diameter increase. Meanwhile the atmosphere in the kiln slowly eats away at the metal of the element. Although the total resistance usually increases as the elements age, sometimes it decreases, or reverses itself. This usually only happens when the elements are very old but have not yet failed completely. As the element expands, it binds up in the corners. This can make the individual coils push together and touch

each other in the corners, making a short cut for the electricity, reducing the amount of element material the electricity must pass through, and therefore reducing the resistance in the whole element. This may make it hotter in the kiln, but if there is a lot of element material jammed in the corners there will not be enough material left in the coiled form to radiate the heat generated by the increased amperage and decreased resistance. Only the parts of the wire not touching the coils on either side of them will emit heat. More amperage through the electrical components in the control could cause damage if the situation continues or the resistance drops far enough. In addition, the expanding diameter of an element can make it difficult to get it out of the holder. Usually this will not happen to those firing to higher temperatures because the maximum temperature of the kiln is quickly compromised by increases in the resistance, requiring the elements to be changed long before they can jam up in the corners. Also, high temperatures and glaze firings are more prone to eating through the element, causing it to fail, before the element can expand enough to cause the problems mentioned above. Visually inspect your elements for the above conditions and do a resistance check. If you see this it may be time to change elements.

### Power Relays

1) Power Relays may cause poor transfer of power to elements when they have been used for a long period of time. It is not always a total failure - which is of course harder to troubleshoot. If these are suspected replace them.

### Bad Wiring

1) Have an electrician check your wiring. We have seen aluminum wire cause intermittent problems with allowing enough voltage through. We do not recommend aluminum wiring. The problem with it is that aluminum oxide, which is formed from heat, is a resistor while copper oxide is not a resistor. With kilns you will often develop some heat in the electrical lines. If all connections are perfect and the wire is oversized you probably will not have a problem - but why take that chance? Make sure your wires are of the proper size and that all connections are good.

# TROUBLESHOOTING & FIXING EASY-FIRE KILN (EUROPEAN VERSION)

## **WIRES WILL GET HOT**

Unlike many other appliances that use electricity (like motors) kilns are called a “resistive load.” This means that there will be a continuous pull of steady electrical power for many hours. Even with properly sized wire this will generate SOME heat in the wires. If you look carefully you will see that we have **OVERSIZED** our internal power wires far in excess of their rated capacity. In addition all our power wire is rated for very high temperatures. The larger the wires the less resistance in the wires and the cooler they will operate.

- 2) Check your circuit breaker for proper operation. These sometimes go bad over time.
- 3) If all the elements are firing and the kiln is still firing too slow check the amperage draw of the kiln under a full load. **CAUTION: This test should only be done by an experienced person familiar with electricity and its dangers. You need to see what the voltage is when the kiln is firing.**

*Check amperage under load with an amp-probe:*



- 4) You can tell if all zones are firing by pressing the number **8** on the control numeric pad. You will see one little light per zone under the numbers on the control display. If you see two dots on an e23S-eu or e28S-eu then you are firing at full load. If you see three dots on an e18T-eu, e23T-eu or e28T-eu then you are firing at full load. See if the amperage drawn

is the same as what the kiln is rated for. See the product literature and/or data nameplate on the kiln for the rated amperage draw. If it is substantially less than the rated amperage draw and your voltage is within 5% of the rated voltage, then chances are the elements have changed in resistance. This will require element replacement.

**Pressing the number “8” will turn on 2 or 3 small LEDs that indicate whether the various zones are firing.**

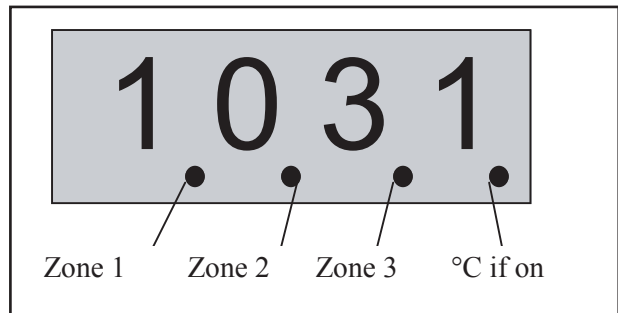

## **Wiring in the Kiln**

- 1) Unplug kiln or shut off power to the kiln.
- 2) Trace wiring for missing or bad connections.
- 3) Check wiring against wiring diagram.
- 4) Check for corroded connectors or connectors that have frayed wires. Replace if you see this.

## **Element Connections**

- 1) The holes where the elements go through the firebrick walls could be too large (perhaps from changing elements at some point in the past). This could cause too much heat to escape from the kiln thereby overheating the element terminals. This can be remedied by lightly stuffing non-RCF ceramic fiber in the element holes. (See the Parts List for non-RCF fiber). You can stuff this in from the inside of the kiln using a sharp tool like a very small screw driver.
- 2) Check to see if the element ends are twisted properly. They should be twisted clockwise around the terminal screw. If the twist is too loose this could generate extra heat at the element ends. Check for corrosion on the terminal. If there is corrosion sometimes you can remove it with a wire brush. (Note that the element connection hardware is all stainless

## TROUBLESHOOTING & FIXING EASY-FIRE KILN (EUROPEAN VERSION)

steel).

*Photo of element terminal with element end twisted around it properly:*



3) The element connection hardware may not be tight enough. A loose connection can generate heat and cause oxidation of the hardware which in turn will cause a worse electrical connection (because of resistance) and more heat. Replace with new hardware.

### Heat Leakage & Vents

- 1) Make sure peephole and vent plugs are in.
- 2) Make sure hole for vent is proper. Check Vent-Sure instructions for proper hole sizes.
- 3) If you are using a different brand of vent make sure it is the appropriate size for your kiln. Check with the vent manufacturer and tell them how many cubic feet are in your kiln.
- 4) If your lid or bottom is cracked check to see if it seems to be leaking much heat at high temperatures. Patch or replace if extreme. (SOME IS OK).

### Single vs Three Zone Control

1) Three zone control will slow a kiln down. It helps even out the temperatures in a kiln by shutting off one or more zones while firing. In addition zone control introduces other issues like **LAG** that sometimes complicate a firing. **The first thing to try if you are getting a slow firing is to switch the kiln to single zone operation.** That may get you back into operation quickly. Then, if that makes the problem go away you can fine tune the specific issue within the zone system that is causing the problem.

2) Normally models e18S-eu, e23S-eu and e28S-eu are programmed to have two zones and models e18T-eu, e23T-eu and e28T-eu are programmed to have three zone control. You can easily change this to be single zone operation.

a) Press **OTHER, 4, 4, 3**

b) The display says **notC** This stands for “number of thermocouples”.

c) To run the kiln using only one thermocouple press **ENTER** at the **notC** prompt. You will then see **0003** or **0002** (depending on whether it is currently programmed for three zones or two zones). Then press **1**, then **ENTER**. The display will then say **StOP**. All the zones of the kiln will turn on and off simultaneously when you program the Dynatrol to use only one thermocouple. (It will use TC2).

d) To run the kiln using only two thermocouples press **ENTER** at the **notC** prompt. You will then see **0003** or **0001** (depending on whether it is currently programmed for one zone or three zones). Then press **2**, then **ENTER**. The display will then say **StOP**. When you program the Dynatrol to run using only two thermocouples the bottom zone and the middle zone go on and off simultaneously. If you have a three section kiln the bottom section and the middle section will work off the middle (#2) thermocouple and they will fire together. This configuration can be an interesting option to help speed up the kiln but still get some advantage from the zone system.

e) To run the kiln using three thermocouples press **ENTER** at the **notC** prompt. You will then see **0002** or **0001** (depending on whether it is currently programmed for one zone or two zones). Then press **3**, then **ENTER**. The display will then say **StOP**. If you choose to do this thermocouple #1 must be in the top zone, thermocouple #2 in the middle, and #3 in the bottom. All three zones will operate independently, tied to their respective thermocouples.

f) To exit the **OTHER-4-4-3** series of menus without doing anything press **OTHER** until you come to **Pct**. Then press **ENTER** twice. You will then see **CPL**, and then **IdLE**, **tC2**, and the current temperature cycling in the display again.



# TROUBLESHOOTING & FIXING

## EASY-FIRE KILN (EUROPEAN VERSION)

### LAG Setting

1) **LAG** is the zone control setting that determines the temperature differential allowed between zones.

2) The lower the **LAG** number the more even the firing. However, this can slow the kiln down considerably. It is somewhat like a convoy - the kiln can only move as fast as its slowest zone (although of course it is more complicated than this because the faster zones help heat the slower zones).

3) The default **LAG** setting is **14**. If you increase this to **25** or even **40** it allows the kiln to fire its zones with a greater differential which will speed the kiln up.

4) Press **OTHER** until you see **LAG**.

5) Hit **ENTER**.

6) You will see **LAG** and a number such as **0014** flash.

7) Input a new number (from 3 to 55 in Deg C or 5 to 99 in Deg F) with the keypad and hit **ENTER**. We do not recommend less than **14** unless you have a very critical process and where speed is not an issue like on low fire. A very low number like **0003** could really slow the kiln down. If you want lower than **0014** try **0012** or **0007**.

8) **AUL6** (Autolag) will now display, flashing with either **On** or **OFF**. See next section.

### Autolag Setting

1) **Autolag** automatically disables the **LAG** control until the end of the firing.

2) Having **Autolag** turned **On** speeds up the firing considerably. Most ceramics applications do not require exceptional uniformity until the end of the firing. With **Autolag On** the **LAG** feature is disabled until the last 25°C (45°F) of the firing when it comes back on to its programmed setting. Basically this allows the faster sections to help pull the slower sections along.

3) However, for glass and other industrial applications turning **OFF** Autolag is probably recommended.

4) Press **OTHER** until **LAG** appears.

5) Press **ENTER**.

6) As soon as you press **ENTER** after entering the **LAG** setting (you can leave it as is - just press **ENTER**) you will see **AUL6** for approximately two seconds, and then see either **On** or **OFF**.

7) Press **1** to toggle between **ON** and **OFF**.

8) Then press **ENTER**

### ShtO (Shut-Off) Setting

1) This option is used to shut off the automatic feature in the Dynatrol that holds the hottest part of the kiln at each segment's set point until the average of the three (or two) thermocouples reaches that set point. This can have a dramatic effect on speed of firing and is worth trying to see if it helps you if you are having a problem.

2) When you press **OTHER, 4, 4, 3**.

3) Press **OTHER** until **ShtO** is displayed.

4) Pressing **ENTER** here allows you to toggle, using any number key, between **On** and **OFF**.

5) **On** means that as soon as the hottest zone gets to the segment's set point the entire kiln switches to either the "hold time" or the next segment. This will result in a quicker firing.

6) **OFF** means that the Dynatrol will not let the hottest zone's temperature rise until the average temperature of the three zones reaches that segment's set point. Then the kiln can begin the "hold time" or the next segment. This will result in more even firing.

7) When you have the setting you want shown in the display (**On** or **OFF**) press **ENTER**. **CPL** will display for a few seconds and then **IdLE**, **tC2** and **current temperature**.

### Pld Setting

1) This setting generally should be left at its factory default because it is hard to predict the changes that it will create in your firing. However, a full explanation is given for more advanced users who want to experiment with this.

2) This setting comes pre-programmed at the factory for 65%. Basically this setting determines how much help the middle zone of the kiln gives the bottom zone

# TROUBLESHOOTING & FIXING

## EASY-FIRE KILN (EUROPEAN VERSION)

of the kiln when the bottom zone is lagging behind during heating. This comes into play when the bottom zone is on 100% of the time. With this feature, the middle zone of the kiln will come on the programmed percent (Pid) of the time that the TOP zone comes on, if the bottom zone is on all the time. Tests showed that if the bottom was on 100% of the time, the top zone was generally on 90% of the time, but the middle zone was on only about 40% of the time. By programming a higher percent you can greatly speed up your firings. (you will have to experiment, try the factory setting 65% then try maybe 100% and compare your results). Basically the higher the **PId** setting the faster the firing at the potential price of UNEVENNESS.

3) As your elements age firing by firing, this setting will activate earlier and earlier in the firing because the bottom will be working at 100% earlier and earlier. This will allow the artificial inflation of the center's temperature sooner and sooner. Because this center is heating based on mathematics now and not it's own thermocouple's reading, it will have a longer and longer period of time to get hotter than the top and the bottom. In some cases this can lead to gross UNEVENNESS. You may find yourself dialing down the PId to something like 50% or 60%. Remember that if it is set around 40% (it's normal operating percentage) or below, the thermocouple's reading then will be the control for that section, not the mathematics of the **PId** feature.

4) When display flashes **IDLe**, **tC2** press **OTHER** see **rSEt**. Press **4, 4, 3**. See **notC**

5) Keep pressing **OTHER** to cycle through the menu options until you get to **PId**.

6) Press **ENTER**. See **PCt**, **0085** cycling.

7) Press any number from **0** to **150**, see the number you have entered preceded by a zero like **0120** if you entered **120**. Press **ENTER**, see **CPL** or **StOP** for a few seconds, then **IDLE**, etc.

8) Pressing **ENTER** here allows you set another percent setting that can help a slow, heavily loaded kiln fire faster.

### Adding More Insulation

1) In L&L's top loading kilns an additional bottom may be placed under the original bottom. This will improve the insulation in the kiln, thereby slowing heat loss and speeding the firing time. You can also put a 10cm (2") layer of calcium silicate on top of the stand beneath the bottom of the kiln.

2) Also try raising the height of the kiln from the floor or putting a reflective stainless steel or aluminum sheet under the kiln. All these things keep the floor from absorbing the radiant energy from the kiln and will improve heat up times (as well as bottom of the kiln uniformity).

3) Put a 5cm (1") layer of non-RCF ceramic fiber on the lid. This is completely non-hazardous which is important in this application because you will be releasing fibers into the air when you move it while loading. While this is a somewhat extreme measure we have found that a disproportionate amount of the heat loss from a kiln is through the top. Non-RCF ceramic fiber is soluble in the body and is considered totally safe. (See the Parts List).

4) Whatever you do be sure NOT to put the kiln directly on the floor. If the floor is cement or other hard non-flammable material it will absorb the heat from the kiln. If the floor is wood or other flammable material you will create a very DANGEROUS situation which could cause a serious fire.

## **KILN HEATS TOO FAST**

### **Voltage**

1) Check your voltage. Some people may have high voltage like 245 volts where you should nominally have 230 volts.

### **Elements**

1) Check element ohms and compare with factory values. (See CHECKING ELEMENT OHMS).

# TROUBLESHOOTING & FIXING

## EASY-FIRE KILN (EUROPEAN VERSION)

### **ERROR MESSAGES**

Error codes can appear at any time during the firing. They always refer to a problem that, if allowed to continue, could end with unknown or even disastrous results. **Errd**, **Err1**, **ErrP** and the **FAIL** message make the most frequent appearances. **Errd** means there is a temperature difference of more than 100 degrees between the zones. **Err1** indicates that the kiln is climbing too slowly in an Easy-Fire program to calculate what the final temperature should be, based on what cone you have programmed it to fire to. **ErrP** indicates that there was either a very quick power outage (**ErrP** will flash along with the temperature and the kiln will still be heating), or there was a longer power outage (**ErrP** will be the only thing in the display and the kiln will not be heating). **FAIL** refers to a specific thermocouple failure. It will appear after displaying a 'tC' (thermocouple) number **1**, **2** or **3**.

#### **Errd**

1) If the kiln was just re-assembled and **Errd** is the error code, then double-check that the element connection wires go to their proper power relays and that the thermocouple wires are connected to the proper zones.

2) If you are sure the kiln is set up properly, nothing is out of place and none of the thermocouples are partially out of the kiln, then one of the following situations may apply:

3) You were firing with the lid open and you got **Errd** either while the lid was open or right after you closed it. For drying with the lid open, only about two inches is needed to adequately vent off water vapor. This is plenty if all the peep holes are open. The Dynatrol will attempt to compensate for the heat loss, and it usually can. The trouble may happen when you close the lid. The elements in the top of the kiln are already much hotter than the ones nearer the bottom due to their need to compensate for the heat loss from the top. When you close the lid it can take as long as eight seconds for the Dynatrol to respond to the rise in temperature in the top of the kiln, and shut off those elements. This can quickly cause an uneven temperature in the kiln, which will usually result in **Errd** (possibly an **Err2** in a smaller kiln -**Err2** is when the entire kiln temperature is more than 27°C (50°F) over

the hold time's temperature for longer than 18 seconds).

4) There was a lot of air being exhausted from your kiln when **Errd** appeared. If a vent system pulls too much air from just one point in the kiln, say, to down-ramp the load very quickly to a lower hold time for crystal formation, an uneven temperature can result. The firing will go slowly as it will be difficult to compensate for the heat loss; eventually, however, the **Errd** (or **Err1**) can appear.

5) **Errd** just appeared, the middle TC reads about 70°C lower than the other TCs. In order of most likely to least likely:

a) Something is too close to, or is touching, TC2 in the kiln. Allow almost an inch between everything for thermal expansion. Fix and re-fire the kiln.

b) A thermocouple wire has melted against the kiln case. The wire must be replaced.

c) A thermocouple is about to fail. Perform a physical inspection if possible, or just re-start the kiln and monitor it carefully.

d) Element(s) just burned out. Perform an ohms test for more information.

e) A relay has just failed. Perform a voltage test.

f) There is a bad connection point somewhere. This will become more of a possibility as the kiln ages. Examine all points carefully for melting, corrosion, discoloration and/or bad electrical smell.

#### **Err1**

1) If **Err1** is the error code on the screen when you check on the firing, then for some reason the kiln could not generate enough heat to counter the heat loss. If the kiln can get no hotter (even though all the elements appear to be on and the program is not holding), then **Err1** is what you will see. If one of the elements or one of the circuits in the control fails while the kiln is at a high enough temperature then it will probably display an **Err8** code (which means temperature is falling when it should be rising) **Err1** or **Err8** can mean either you need new elements or a new component in one of the circuits. An ohms test and a voltage test can tell you which it is. If you

## TROUBLESHOOTING & FIXING EASY-FIRE KILN (EUROPEAN VERSION)

recently changed locations, power supplies, elements, or did any repairs, then closely examine what changed between your last successful firing and this one. There may be some other issue besides bad elements or a bad component.

2) In re-wiring the power supply you may not have used thick enough copper wire (line, conduit and connection points will be very hot).

3) The elements are the wrong resistance. Check new elements with your multimeter just to be safe. Mistakes can happen.

4) If you rewire anything improperly or incorrectly the potential for anything from a blown breaker to just no power at all is possible. (Using wire with a temperature rating of less than 150°C for the power wiring can seriously limit the life of the circuitry and can be dangerous as well, especially when the wires are close to the kiln. Use a wire diagram and trace every wire to check yourself).

### **Err2**

During a hold segment the temperature rises to greater than 22°C above the hold temperature which was set. The temperature must stay 22°C above this set temperature for 18 seconds before the error is displayed.

### **Err3**

During a hold segment the temperature is more than 50 degrees below the hold temperature which was set. The temperature must stay 22°C below this set temperature for 18 seconds before the error is displayed.

### **Err4**

The temperature is more than 22°C above the previous hold temperature during a ramp segment where the temperature is programmed to decrease. The temperature must stay 22°C above this set temperature for 18 seconds before the error is displayed.

### **Err5**

The temperature is more than 22°C below the local setpoint temperature during a ramp segment where

the temperature is programmed to decrease. The temperature must stay 22°C below this set temperature for 18 seconds before the error is displayed.

### **Err6**

A Negative temperature is displayed. This generally indicates the thermocouple is connected incorrectly. To correct this situation, ensure the red and yellow wires are connected correctly to the controller and at all junctions. You can identify the red lead on an unmarked thermocouple with a magnet because a magnet will be attracted to the red lead.

### **Err7**

The temperature is more than 22°C degrees above the local setpoint temperature during a ramp segment where the temperature is programmed to increase. The temperature must stay 22°C above this set temperature for 18 seconds before the error is displayed.

### **Err8**

When using the Easy Fire Mode, the temperature is decreasing during the last ramp segment. This could indicate that the lid was up or the peepholes open or some other physical thing is causing the kiln to decrease in temperature.

### **ErrP**

Continuous **ErrP** in display. Indicates a long term power outage. The kiln has been shut down. Press **1** to clear the display.

**ErrP** and the current temperature are alternately flashing. To clear the display, press the **1** key. If a firing was in progress, the kiln will continue to fire even though this message is flashing. This error can also happen as a result of RF noise that resets the microprocessor. If this is suspected, the control panel should be returned for testing and possible modification.

### **Err-**

The Err with a dash indicates there was a power loss to the controller while writing a program to the non-volatile memory chip. Recheck the selected program, and reprogram if necessary.



# TROUBLESHOOTING & FIXING

## EASY-FIRE KILN (EUROPEAN VERSION)

### **ErrE**

A hardware error has been detected by the controller software. The controller must be replaced.

### **FAIL**

1) If, upon inspection, the error code **FAIL** turns out to be a burned out thermocouple then replace it. You typically will not need to replace the mullite protection tube - just the internal thermocouple "element" (P/N #T-G-E800/00). You should not mix unsheathed thermocouples with sheathed ones. (because their response rates are slightly different). A spare on hand is a good idea as well.

2) Sometimes the code **CPLt** will be displayed. This code is always displayed after a successful firing to mean 'complete'. If it appears after you attempt to re-start the kiln after a **FAIL** message, or at any other time except for the end of the firing to mean 'complete', then it will have a different meaning. If **CPLt** appears randomly it means either your TC wires are burning against the kiln case or your TCs are so close to failing that they are giving a reading that is so high that the Dynatrol thinks the firing is over.

3) If the TCs are not bad (you just replaced them and they worked fine for at least one complete firing) but the **FAIL** message still appears, it may be that the TC wire is bad (melted or broken at a point) or the electronics have partially failed.

A) Turn OFF the power at the Disconnect Switch or Circuit Breaker and/or unplug the kiln.

B) Open the cover of the control.

C) Remove the Thermocouple wires from the Dynatrol and the Thermocouple Terminal Strip. Take out of the Control Box and set aside.

D) Make tiny "U" shaped jumper wires from paperclips and jumper between each of the + and - connections on the Dynatrol board.

E) You are simply completing each TC circuit without using the TC wire or the TC. Do not let the 'U's touch anything other than the TC connection points. Note: the fact that a paperclip is not the proper type of metal to use in a Type K TC circuit is not an issue for a test like this.

F) Close up the Control Box and turn the unit on. If it still says **FAIL** then the electronic board has failed. If it reads room temperature then the TC wire or the TC has failed.

G) If it reads room temperature with these jumpers in, and you are not sure if it is the TC or the TC wire, just re-attach TC2's wire to TC3 and re-attach TC3's wire to TC2. If the **FAIL** message is still on TC2 then it is the wire, not the TC. If it says that the **FAIL** is now at TC3, then you know it is the TC, not the wire (there are many other ways to determine this as well).

### **Turning Error Codes On or Off**

1) When you receive your Dynatrol the error codes are turned on. In most cases, you will want the error codes on. They can be turned off if you are doing special firings, such as jewelry or glass firing where the kiln is opened while hot. Turning the error codes off turns off the dynamic zone control feature that keeps the temperature in the kiln even top to bottom. It eliminates nuisance shut downs but side steps built in fail-safe measures.

2) The only Error codes that this can not turn off are **Err6**, **FAIL**, and **ErrP** in both the "Easy Fire" and "Vary Fire" modes. In addition **Err1** and **Err8** are not turned off in the last segment of an "Easy Fire" program. This is because the built in calculations would make no sense if the kiln were firing too slowly.

3) To turn Error Codes off do the following:

4) Press the **OTHER** button several times until you see **ErCd**.

5) Press **ENTER**

6) Display will say **On** (which indicates that the error codes are turned on) or **OFF** (which indicates that the Error Codes are Off). You can toggle back and forth between on and off by pressing the **1** key.

7) Hit **ENTER** when you see **On** or **OFF** and you want to keep that setting

8) **CPL** will display for a few seconds. **IdLE**, **tC2**, and the current temperature then cycle in the display.

# TROUBLESHOOTING & FIXING EASY-FIRE KILN (EUROPEAN VERSION)

## Can you restart the kiln after it stops because of Error Codes?

You can try to restart the kiln after getting an error code. Some messages, like flashing **ErrP** and **FAIL**, will not necessarily turn off the kiln. Depending on the problem though, re-starting it may or may not let it finish the firing, or even start up again. An **Errd** will usually not re-start easily because the temperature top to bottom is drastically different. An **Err1** at the end of the firing will re-start but will probably re-occur in about 22 minutes. A **FAIL** message will not go away even if the problem is fixed during the firing. The kiln can still be firing with the **FAIL** message flashing along with the number of the TC that failed. Stopping and then re-starting the kiln after fixing the problem with the TC circuit is the only way to erase the **FAIL** message. **ErrP** flashing with the temperature means that the kiln is still firing, after just a short power outage or interference. Just press any number to clear the **ErrP**. An **ErrP** which is not flashing must be re-started.

## REMOVING PANEL FOR SERVICE

1) It is easy to access the inside of the control panel for troubleshooting. In addition it is easy to remove this panel and send it back to the factory for inspection and/or repair.

2) Unplug the kiln.

3) Follow the instructions in the Assembly Instructions for removing the Control Box.

4) Pack the control panel with cushioning material such as bubble wrap, balled-up newspaper or foam in a cardboard box and follow instructions from your local distributor about where to send it. **DO NOT SEND A CONTROL PANEL WITHOUT CALLING FIRST.**

**CAUTION:** The controller contains electronic components which are sensitive to static electricity. Before handling the controller dissipate any static charge you may have by touching metal on the kiln or some other grounded object.

## REPLACING DYNATROL

1) Unplug kiln or turn off the kiln at the fused disconnect switch.

2) Remove the four #6 screws that hold the Dynatrol in place from the front face of the control panel.

3) Open up the control box and hinge down for access (as shown on page 2)

4) Pull off the spade connectors from all the connection points on the back of the control. Loosen the screws that hold down the thermocouple wires and pull out the wires from under the screw heads. It is OK to remove the screws if this is easier for you. First note where all the wires go. These are all clearly marked with color coding on the Wiring Diagram.

5) Pull old control out. Put new control in and screw in place with the #6 mounting screws. Replace wires on proper connectors.

6) Be careful to get the Green or White of the thermocouple wires to match the colors painted on the Dynatrol board. The Negative thermocouple terminals on the DynaTrol are painted RED and the Positive terminals are painted YELLOW. The White TC wire is negative and the Green TC Wire is positive.

*Picture showing thermocouple wires installed on Dynatrol. There is no need to wrap the thermocouple wire around the screw head- although it is OK to do so. However, do make sure the wire is tight and secure UNDER the screw head:*

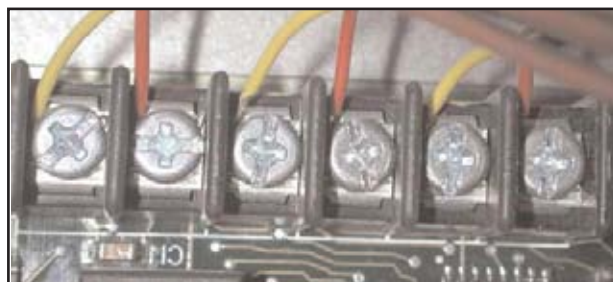

# TROUBLESHOOTING & FIXING EASY-FIRE KILN (EUROPEAN VERSION)

7) Double check that the proper color coded wire goes to the proper terminal.

*Orange = OUT 1, Yellow = OUT 2*

*Purple = OUT 3 (not on e185-eu, e235-eu & e285)*

*Gray = AC1, Green-Yellow = CT, Brown = AC2*

*TC1 = TC1, TC2 = TC2*

*TC3 = TC3 (not on e185-eu, e235-eu and e285-eu)*

## **REPLACING TRANSFORMER**

1) Unplug kiln or turn off the kiln at the fused disconnect switch.

2) Open up the control box and hinge down for access (as shown on page 2).

3) Using needle nose pliers pull off the wires from the transformer. **THIS CAN BE TRICKY.** It can take a good bit of force sometimes to remove these little spade connectors. You will probably not be able to do it with just your hands. Also the spade connectors on the transformer are not very strong. Take your time. Of course, if you are replacing a bad transformer it doesn't matter if you damage it.

*Picture showing wires being pulled off the control transformer.*



4) Unscrew the two #8 screws that hold the control transformer onto the Contactor Panel and remove the transformer.

5) Before installing the new transformer put the small jumper wire onto terminals #2 and #3 on the bottom row of terminals. Note the little numbers by the contacts.

## **REPLACING POWER RELAYS**

1) Unplug kiln or turn off the kiln at the fused disconnect switch.

2) Open up the control box and hinge down for access (as shown on page 2).

3) Pull off the wires to the relay(s) that you are replacing. Everything is color coded and marked so you can refer to the wiring diagram when replacing if you forget where the wires go. The wire lengths also don't give you much choice and will help keep you from making a mistake.

4) Unscrew the #8 screws that hold the relays in place. Remove old relay and replace with new one.

5) Visually inspect the wire connectors. Do they look corroded or "cooked"? Are the wires frayed? Any corrosion on the wire itself? If any of this is questionable you may need to replace the appropriate wire harness.

6) Reconnect all wires. Visually inspect to make sure the spade connectors are down as far as they can go and feel to see that they are tight (a gentle tug should not remove one). If they are loose for some reason remove the wire and slightly squeeze the spade connector with pliers to tighten it.

**IMPORTANT:** The slip on wire connectors can not be loose or corroded. If there is a bad connection then heat will be generated and the component that they slip onto (relay, terminal strip, etc) may overheat and fail. If you squeeze the slip on terminal to make it tighter - be sure to squeeze it evenly so that one side is not tight and the other loose. If there are any doubts about the integrity of the wire or the connector replace the whole wire or harness.

## **REPLACING FUSE HOLDER**

1) Unplug kiln or turn off the kiln at the fused disconnect switch.

2) Open up the control box and hinge down for access (as shown on page 2).

## TROUBLESHOOTING & FIXING EASY-FIRE KILN (EUROPEAN VERSION)

- 3) Remove the wire connectors from the end of the fuse holder on the inside of the panel.
- 4) Unscrew the nut that holds the fuse holder in place.
- 5) Remove and replace with a new fuse holder. Reconnect wires.

### **REPLACING ELEMENT SHUTOFF SWITCH**

- 1) Unplug kiln or turn off the kiln at the fused disconnect switch.
- 2) Open up the control panel.
- 3) Remove the screws that hold the Plate to the top of the control panel.
- 4) Pull the entire assembly up which will include the element shutoff switch, plate and mounting screws and spacers.
- 5) Remove power wires. Mark wires to make sure you put them back where they belong when you change the switch.
- 6) Undo nuts from the spacer/attachment bolts and remove switch.

*Picture showing switch system from the outside:*

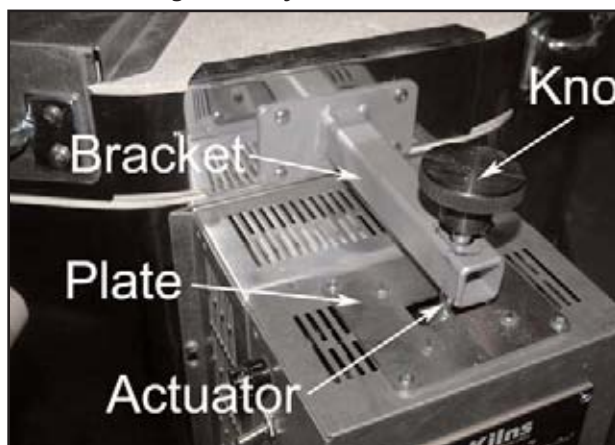

*Picture showing switch inside panel:*

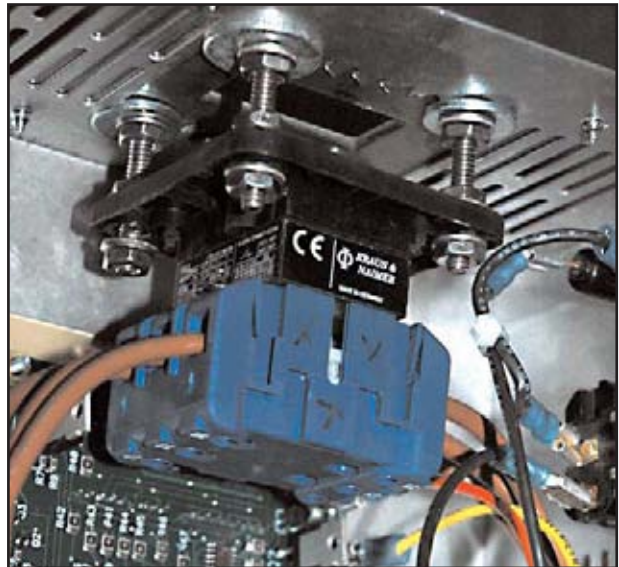

### **REPLACING THERMOCOUPLES**

- 1) Unplug kiln or turn off the kiln at the fused disconnect switch.
- 2) Remove the Control Box and Element Terminal Box as shown in the Assembly Instructions.
- 3) Remove the Thermocouple Lead Wires.
- 4) Unscrew the Thermocouple from the kiln (these are #6 x 1-1/2" screws)
- 5) Remove Thermocouple.
- 6) Remove Thermocouple Protection Tube. Shake it and dump out the oxide powder that has accumulated inside the tube. Then reinsert the tube into the hole in the kiln.
- 7) Install a new Thermocouple and screw in place.
- 8) Replace Thermocouple Lead Wires and tighten. Be sure to get Green Wire matched to the Plus sign and the White Wire matched to the Minus sign.



# TROUBLESHOOTING & FIXING EASY-FIRE KILN (EUROPEAN VERSION)

Picture showing end of thermocouple.



Using a sharp tool like a screw driver lift the elements out of the ceramic grooves at the corners. You can slide the holder over to make enough of a gap to get the tool under the element:



## REPLACING ELEMENTS

- 1) Unplug kiln or turn off the kiln at the fused disconnect switch.
- 2) Remove the Control Box and Element Terminal Box as shown in the Assembly Instructions.
- 3) Using a 10mm (3/8") nut driver remove the nuts that hold the element end onto the Element Terminal Bolt. If you don't have this tool you can use an adjustable wrench - it will just take longer.

**A 3/8" nut driver (available from us - see Parts List) or from a local hardware store):**



- 4) Untwist the element end from around the Element Terminal Bolt. Straighten it out as much as possible.

**Untightening the element terminal:**



- 5) In most cases you can just lift the element out of the holder at this point. Sometimes, if the element has really disintegrated, you need to remove it in pieces with needle nose pliers.

**Lift Elements out of the groove of the ceramic holders:**



- 6) If element is hard to get out of the holders (because of growth of the element) you can try heating up the kiln slightly so as to heat up the element slightly to just the point where element is slightly pliable - don't let it get red. This will soften the wire. Then turn off the kiln and disconnect all power to the kiln. Then, using heat protecting gloves (such as welding gloves or the gloves that come with the Furniture/Accessory kit) and a pair of needle nose pliers pull out the softened element. **IF YOU DECIDE TO USE THIS METHOD BE VERY CAREFUL OF THE POTENTIAL FOR BURNING YOURSELF.**

- 7) From the inside of the kiln, using needle nose pliers, grab the element as close to where it goes

## TROUBLESHOOTING & FIXING EASY-FIRE KILN (EUROPEAN VERSION)

through the brick wall to the Terminal Block. Pull the element end through the hole. Be careful not to enlarge the hole in the firebrick. The brick is quite soft and will not take much abrasion.

### **Removing element from inside the kiln:**



8) Be sure to check for failure points for evidence of contamination on the element and the element holder. If the element holder is contaminated it will cause rapid failure of the new element. Replace contaminated holders with new ones.

9) Using your multimeter check the resistance of your new element. Check it against the chart at the back of this Troubleshooting Guide.

**Checking resistance of the elements before you put them in. This is a good double-check and can save you a lot of trouble if there is a mistake. Put the probes on the twisted element ends about 8cm (3") from the beginning of the coil:**



10) Install the twisted ends of the elements through the holes in the wall of the kiln. Element ends should be straight at this point.

11) Pull them up tight up to the wall of the kiln by pulling from outside the kiln.

12. Lay the element into the groove. Note that the unfired element is going to have some springiness to it before it is fired for the first time. You may need to use a screw driver to press the element into the holder. **YOU DO NOT NEED PINS.**

13) Install the elements and hardware:

- a) A washer goes under the first element
- b) Twist the first element end **CLOCKWISE** around the Terminal Bolt.
- c) The next element gets twisted around the Terminal Bolt on top of the first element.
- d) Then another washer goes over the Terminal Bolt.
- e) Then the nut goes over it and get tightened.
- f) Then a washer goes on.
- g) Then the Ring Terminal of the Power Lead Wire goes on. Note that it is not critical which of each of the two wires goes on which terminal.
- h) Then a washer goes on.
- i) Then another nut goes on and gets tightened.

**Detail showing how all the hardware gets assembled on the Terminal Bolt:**



## TROUBLESHOOTING & FIXING EASY-FIRE KILN (EUROPEAN VERSION)

*Photo of element terminal with elements and Power Lead Wires shown connected.*



*Just take your time with this. You can break the holder into little pieces so that it comes out:*



*The holder shown with about half the job done:*



*The groove is shown with the holder removed:*



### **REPLACING ELEMENT HOLDERS**

- 1) When ordering a new holder provide model number of kiln and length of the element holder. See the Parts List for this information.
- 2) Note that if the holder has melted badly you may need to either replace the brick that holds it or at least patch the brick with our Brick Repair Kit.

#### **Method #1**

- 1) This method leaves the kiln in tact. You break up the holder and remove it in pieces and then modify the new holder to snap into the groove.
- 2) Using a chisel or large screw driver and a hammer carefully crack the holder that needs to be removed.



## TROUBLESHOOTING & FIXING EASY-FIRE KILN (EUROPEAN VERSION)

*Using Linemen's Pliers snap off the **BOTTOM** edge of the holder (note carefully the fact that the **BOTTOM** of the groove is closest to the edge that you are breaking off.):*



*A normal holder compared to one with edge removed:*



*You can now just snap the new holder into the slot in the firebrick. It will hold in place with no cement:*



### **Method #2**

This method requires you to take the kiln sections apart.

- 1) Take the section with the bad holder off the kiln and put it on a flat surface like a flat floor or table.
- 2) Carefully pull the elements out of the element holders of the brick section involved and allow them to hang loose. Take great care not to "break" the element as they are very brittle after firing.
- 4) Loosen up the adjustable clamps that hold the stainless steel wrapping. Loosen them just enough to allow the brick to slide out with slight hand pressure (so that the other bricks stay in place). NOTE: If you don't have the section on a flat surface then the bricks will all come out of proper alignment at this point.
- 5) Pull up the brick with the bad element holder just enough to allow removal of the defective element holder and replace with new one. Slide the bad brick(s) out and put in new brick(s). Be sure the element holders line up with the other holders on either side. Note there is a top and a bottom in the element holder so be sure to get the orientation correct.
- 6) Retighten the clamps on the wrap. Alternately tighten the bottom and top clamp so that you don't cock the stainless casing.

### **CRACKS IN THE LID & BOTTOM**

- 1) It is quite normal to get hairline cracks in both the lid and the bottom firebricks.
- 2) They are caused by the expansion and contraction of the firebrick as it heats and cools.
- 3) As long as the bottom is fully supported by the stand the cracks in the bottom will not adversely affect the operation of the kiln.
- 4) The stainless steel clips we use in our lids also help keep these natural cracks from normally becoming a problem.
- 5) Note that it is possible to put another bottom under the original bottom as a second layer (this can also improve performance and heat up rate of the kiln).
- 6) It generally does not make sense to cement these hairline cracks.
- 7) You can tighten the stainless steel band.

# TROUBLESHOOTING & FIXING EASY-FIRE KILN (EUROPEAN VERSION)

*This crack is OK:*



## **TIGHTENING STAINLESS BANDS**

- 1) The brick will shrink slightly over time. This is more pronounced when using the kiln at higher temperatures like cone 10 (1285°C).
- 2) If the bricks shrink too much they will become loose.
- 3) Tighten the case by turning the screws of the case clamps. Do this 1/4 of a turn at a time on each of the clamps. Keep a balanced tightening (i.e don't tighten one clamp too much at one time). Slow is good.

*Tightening the bands:*



- 4) You can do this on the bands around the top and bottom also. This will help maintain the integrity of those slabs even if there is a crack.

## **REPLACING FIREBRICK IN SIDES**

- 1) If you need to replace a firebrick piece in one of the sections do the following. While it does not require a great deal of experience to accomplish it does take time and patience.
- 2) Order the firebrick precut and pre-routed from L&L Kiln. You can order this with the proper element holders already in place or you can reuse the holders from your old brick. Be sure to order it for your specific model kiln. Also, be sure to say whether it is a brick where the element connections come through (because this has different element holders. There are no holes drilled in the brick for either peepholes or element connections. This has to be done in the field.
- 3) Take the section off the kiln and put it on a flat surface like a flat floor or table. Elements will have to be removed and probably replaced.
- 4) Loosen up the adjustable clamps that hold the stainless steel wrapping. Loosen them just enough to allow the brick to slide out with slight hand pressure (so that the other bricks stay in place). NOTE: If you don't have the section on a flat surface then the bricks will all come out of proper alignment at this point.
- 5) Slide the bad brick(s) out and put in new brick(s). Be sure the element holders line up with the other holders on either side. Note there is a top and a bottom in the element holder so be sure to get the orientation correct.
- 6) Retighten the clamps on the wrap. Alternately tighten the bottom and top clamp so that you don't cock the stainless casing.
- 7) Sand off the top surface of the firebrick to match the surface of the other firebricks. Sandpaper will work fine. Reface with facing (See Parts List).

# TROUBLESHOOTING & FIXING EASY-FIRE KILN (EUROPEAN VERSION)

## DRILLING OUT HOLES FOR PEEPHOLES

1) Some of the bricks that you may need to replace will need to have holes drilled in them in the field. These holes can not be drilled in the factory because the alignment would not be perfect.

2) To drill out for peepholes use a 1" diameter drill bit or hole saw. You can also drill with a smaller drill and then file out with a round hasp type file. In all cases the peephole can be drilled perpendicular to the stainless case. You may have to remove the bit several times and clean it out as you drill deeper. It is a good idea to have someone help you by watching from the side to make you you are keeping the drill perpendicular.

*Drilling the peephole:*



3) Drill slowly through the firebrick using the prepunched hole in the stainless steel.

4) Before drilling, as a precaution, you can measure down from the top of the brick to the top of the existing hole in the stainless steel case. This measurement on the inside will show you where the top of the drill bit will protrude. Adjust your angle of drilling accordingly.

## DRILLING OUT FOR THE ELEMENT CONNECTIONS

1) Use a 3mm to 5mm (1/8" to 3/16") diameter drill bit and drill out from the center of the hole in the stainless steel case. Do this slowly with a speed control.

2) Do this perpendicular to the case.

## REPLACING BOTTOMS

1) Remove the kiln sections.

2) Take the old bottom off the stand.

3) Put the new bottom on the stand.

4) Relevel the kiln.

5) Replace the kiln sections.

NOTE: You may want to experiment with using it as a secondary back up bottom if it is not too badly damaged. Some people find that having this extra insulation thickness helps firing times and bottom uniformity).

## REPLACING LIDS

1) Remove the Hinge Pin and take the old top off the kiln. See the Assembly Instructions for guidance if you have questions about how to do this. Use the Hinge Tool to take the tension off the spring. **BE SURE TO USE SAFETY GLASSES - THERE IS A LOT OF TENSION ON THE SPRING AND INJURY COULD RESULT.**

2) Remove the Top Hinge Part from the old lid. Note that there are three parts to this. There is the main Top Hinge Part. Then there is the Front Hinge Part (the little aluminised steel plate with a small hole that gets attached to the front of the top with the screws for the Handle). Then there is the Handle. Note that the hole in the Front Hinge Part should be centered around the little stud that protrudes from the Top Hinge Part.

*A= Top Hinge Part, B= Front Hinge Part, C= Handle  
D=Label*

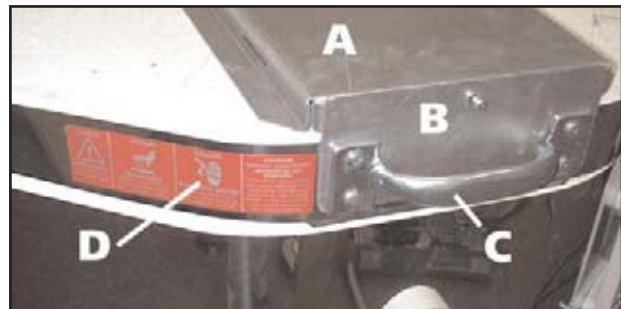



# TROUBLESHOOTING & FIXING EASY-FIRE KILN (EUROPEAN VERSION)

- 3) Using the old top as a guide, install the Top Hinge Part onto the new lid.
- 4) Reinstall the top and reset the spring. See the Assembly Instructions if you have questions about how to do this.

## CHECKING ELEMENT OHMS

- 1) The following chart gives you the ohm ratings for both the individual elements and the ohm ratings for the element circuits.
- 2) It is very easy to check the element circuit ohms.
- 3) Unplug kiln or turn off the kiln at the fused disconnect switch.
- 4) Remove the four #6 screws that hold the Dynatrol in place from the front face of the control panel.
- 5) Open up the control box and hinge down for access (as shown on page 2)
- 6) Using your Multimeter set on Resistance or Ohms check resistance across each of the two or three element circuits. You do this by putting the Multimeter probes at terminal #1 and #2, then #3 and #4, then #4 and #6 (on a three section e18T-eu, e23T-eu or e28T-eu) on the Power Terminal Strip.

### Checking Circuit Ohms at the Power Terminal Strip:



- 7) Each circuit would normally have the same resistance which should match the values given below for the "Circuit Ohms".
- 8) The values should be within 6% to 12% of the listed values. Typically the resistance increases over

time and use and this makes the power generated by the elements decrease. Depending on the temperature you are firing to you may get away with a wider variation.

- 9) We give values for individual elements so that you can check specific element resistance before you put elements in or if you want to isolate the elements.

## Element Ohm Chart

| MODEL           | VOLTS/<br>PHASE | ELEMENT<br>OHMS | CIRCUIT<br>OHMS |
|-----------------|-----------------|-----------------|-----------------|
| e18S-eu-230     | 230/1           | 7.9             | 15.8            |
| e18T-eu-230     | 230/1           | 7.9             | 15.8            |
| e18T-eu-415-3PY | 415/3Y          | 7.9             | 15.8            |
| e23S-eu-230     | 230/1           | 21.5            | 10.8            |
| e23T-eu-230     | 230/1           | 26.5            | 13.3            |
| e23T-eu-415-3PY | 415/3Y          | 24.5            | 12.3            |
| e28S-eu-230     | 230/1           | 17.8            | 8.6             |
| e28T-eu-230     | 230/1           | 26.5            | 13.3            |
| e28T-eu-415-3PY | 415/3Y          | 18.6            | 9.3             |

**Checking resistance of the elements before you put them in. This is a good double-check and can save you trouble if there is a mistake. Put the probes on the twisted element ends about 8cm (3") from the beginning of the coil:**

