

DURA-FIRE INSTRUCTION MANUAL

QUICK START

INSTALLERS

1. If you need to assembly the kiln read the ASSEMBLY section.
2. If you need to hook up the kiln red the INSTALLATION section. The Wriing diagram is located in the WIRING section.
3. Read the CAUTION section for installation cautions.

USERS

1. Read and understand the CAUTIONS section
2. Read the Operation section. This is all you need to know to operate the kiln.
3. If you want to know more about how to operate the control read the CONTROL section. This is very detailed and can be overwhelming. Use it as a reference and for more sophisticated programming and configuration instructions.
4. For ongoing routine kiln maintenance read the MAINTENANCE section. This is something that the kiln operator is responsible for.
5. For more background information on Ceramics process, Cones, and a Log Sheet see the LOG, CONES, TIPS, CERAMIC PROCESS section.

MAINTAINERS

1. Read the TROUBLESHOOTING section, the WIRING section, the PARTS section and the SERVICE & WARRANTY section.

ADMINISTRATORS

1. See the MSDS section if you have any questions about materials used in the kiln.

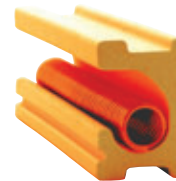

L&L Kiln's patented hard ceramic element holders protect your kiln.

CAUTION INSTRUCTIONS FOR L&L KILNS

CAUTION INSTRUCTIONS	1
KILNS THIS APPLIES TO	1
RESELLERS ARE NOT AUTHORIZED TO MODIFY THESE CAUTION INSTRUCTIONS	1
DATED INFORMATION	1
SAFETY NOTICE	2
ELECTRICAL SAFETY	2
GENERAL	2
ELECTRICAL HAZARDS	2
SHOCK	2
ARC-FLASH	2
ARC-BLAST	2
SAFETY PRINCIPLES	2
INSTALLATION CAUTIONS	3
USE A QUALIFIED ELECTRICIAN	3
CLEARANCES AND FLAMMABLE SURFACES	3
CHECK TEMPERATURES AROUND KILN	3
LEVELING THE KILN	3
ADJUSTING THE HINGE PROPERLY	3
THERMOCOUPLES	3
USE THE SUPPLIED KILN STAND	4
POWER CORD MUST BE PROPERLY RATED	4
USE COPPER WIRE FOR HOOK UP	4
PROTECT POWER CORD FROM KILN CASE	4
KEEP KILN DRY & IN PROTECTED SPACE	4
KEEP A FIRE EXTINGUISHER NEAR KILN	4
SPRINKLER CAUTIONS	4
GENERAL ENVIRONMENT CAUTIONS	5
VENTILATION IS ESSENTIAL	5
AMBIENT TEMPERATURES	5
SURFACE IS HOT AND CAN CAUSE BURNS	5
KEEP CHILDREN/ANIMALS AWAY FROM KILN	5
PRACTICE GOOD HYGIENE	5
TRIPPING HAZARDS	5
CLOTHING TO AVOID	5
PROPER USE OF KILN WASH	6
PREFIRING CAUTIONS	6
KILN WASH CONTAINS SILICA	6
DO NOT USE SILICA SAND	6
NEVER FIRE MOIST GREENWARE	6
CAUTION WITH USE OF WAX	6
DO NOT FIRE TEMPERED GLASS	6
STORE SHELVES IN A DRY LOCATION	6
DO NOT USE CRACKED SHELVES	6
DO NOT FIRE TOXIC, FLAMMABLE, OR UNKNOWN MATERIALS	6
LOADING & UNLOADING CAUTIONS	7
TURN OFF POWER WHILE LOADING	7
KEEP LID CLOSED WHEN KILN IS NOT IN USE	7
DO NOT STORE ANYTHING ON LID	7
DO NOT OPEN THE DOOR ABOVE 250°F	7
DO NOT UNLOAD KILN WHILE HOT	7
BE CAREFUL OF SHARP OBJECTS	7
SECURE LID WHILE LOADING OR UNLOADING IF YOU HAVE A SPRING-LOADED EASY-LIFT HINGE	7
IF YOU HAVE A DAVINCI COUNTERBALANCED LID	7
IF YOU HAVE A BASIC HINGE WITH CHAIN SUPPORTS	7
VIEWING INTO THE KILN	8
FIRING CAUTIONS	8
ATTEND THE FIRING	8
MAKE SURE YOUR KILN SITTER IS ADJUSTED	8
USE KILN WASH ON THE CONE SUPPORTS	8
UNDERSTAND YOUR CONTROL	9
PROGRAM REVIEW ON AUTOMATIC KILNS	9
DO NOT CONFUSE CONE NUMBERS	9
USE THE PROPER THERMOCOUPLE	9
CHECK THERMOCOUPLE CALIBRATION	9
SHUT OFF KILN AT DISCONNECT OR CIRCUIT BREAKER	9
DO NOT FIRE KILN ABOVE 2350°F (1290°C, Cone 10)	9
POST FIRING CAUTIONS	9
CHECK FOR GLAZE AND CERAMIC CHIPS	9
GENERAL MAINTENANCE CAUTIONS	10
ELECTRICAL SAFETY	10
CHECK WIRES & TERMINALS	10
CHECK TEMPERATURE OF CORD	10
CHECK FOR CORRODED CONNECTIONS	10
THE WRONG PARTS CAN BE HAZARDOUS	10
KILN MODIFICATIONS CAUTIONS	11
COATINGS	11
OTHER MODIFICATIONS	11
DO NOT OVERINSULATE KILN	11

CAUTION INSTRUCTIONS

KILNS THIS APPLIES TO

This section covers the caution instructions for the following L&L kilns:

CURRENT PRODUCTION KILNS

- Easy-Fire Kilns (e Series)
- Easy-Fire XT Kilns (X and T Series)
- School-Master Kilns (SM Series)
- Jupiter Automatic Kilns (JD Series)
- eQuad-Pro Production Kilns (eQ Series)
- JH Crystalline Kilns (JH Series)
- Hercules Front-Loading Kilns (EL-H Series)
- Easy-Load Front-Loading Kilns (EL Series)
- DaVinci Automatic Kilns (X and T Series)
- Jupiter Manual Kilns (J Series)
- Dura-Fire Kilns (D Series)
- Doll/Test Kilns (DL and DLH Series)
- Liberty-Belle Kilns (LB Series)

OBSOLETE MODELS

- Econo Kilns (K Series and J Series)
- Programmatic Kilns (B Series)
- Dyna-Kilns (C & H Series)
- Dyna-Kilns (SQ Series)
- Enameling Kilns (E48, E49, R Series)
- Oval Kilns (OV Series)
- Genesis Kilns (G Series)
- Most other L&L kilns

RESELLERS ARE NOT AUTHORIZED TO MODIFY THESE CAUTION INSTRUCTIONS

Distributors and installers of L&L kilns are not authorized by L&L to make modifications or contradict these Caution Instructions (or our Installation Instructions). If L&L's instructions are not followed, L&L specifically disavows responsibility for any injury or damage that may result.

DATED INFORMATION

The information in these Caution Instructions is believed to be correct to the best of our knowledge at the time of publication (see the date at the bottom of this sheet). You can view the most recent update from our web site at www.hotkilns.com/cautions at any time.

CAUTION INSTRUCTIONS FOR L&L KILNS

SAFETY NOTICE

1. All cautions and requirements recommended by L&L Kiln Mfg. Inc. are meant to assist Users to properly and safely operate their kilns. Many of these cautions apply to kilns and ceramic processes in general.
2. By making use of, and/or downloading from, this web site, User acknowledges that process and manufacturing systems improperly installed, maintained, or operated can pose serious and dangerous threats to worker safety, environmental integrity, and product/process quality.
3. Kilns operate at high temperatures and make us of high voltages/amperages and if improperly installed, maintained, or used can cause serious personal or property damages.
4. Commercial kilns are provided with various safety, performance, and operating limits, designs and devices which, if disconnected, altered, tampered with, or changed by User, User's employees, User's agents, or others acting on User's behalf or with User's knowledge, will become User's sole risk and responsibility.
5. User also has the sole responsibility for assigning properly trained persons to operate the kilns who have demonstrated common sense and a general aptitude for such work.
6. It is User's sole responsibility to understand and assure adherence to all safety notices and installation, operating, and maintenance instructions provided by this web site and/or by the kiln manufacturer.

ELECTRICAL SAFETY

GENERAL

Electricity is a wonderful utility, but can be dangerous if not approached carefully. There are three basic hazards that cause injury or death – shock, arc-flash, and arc-blast. It is important to remember that even a small amount of current passing through the chest can cause death. Most deaths occurring for circuits of less than 600 volts happen when people are working on “hot,” energized equipment – PLEASE DISCONNECT AND LOCK OUT ALL ELECTRICAL POWER BEFORE ATTEMPTING KILN REPAIRS!

ELECTRICAL HAZARDS

SHOCK

An electrical shock is a current that passes through the human body. Any electrical current flows through the path of least resistance towards ground; if an external voltage contacts a human body, e.g. by touching a live wire with the hand, the voltage will try to find a ground, and a current will develop that flows through the body's nervous system or vascular system, and exit through the closest part of the body to ground (e.g., the other hand which may be touching a metal pipe.) Nerve shock disrupts the body's normal electrical functions, and can stop the heart or the lungs, or both, causing severe injury or death.

ARC-FLASH

An arc-flash is an extremely high temperature conductive mixture of plasma and gases, which causes very serious burns when it comes into contact with the body, and can ignite flammable clothing. Arc temperatures reach up to 35,000°F – which is 4X the temperature of the sun's surface!

ARC-BLAST

Arc-blast is a pressure wave resulting from arcing, which can carry molten metal fragments and plasma gasses at very high speeds and distances. This can not only carry very hot shrapnel to injure a person, but can actually be strong enough to destroy structures or knock workers off ladders.

SAFETY PRINCIPLES

Be safe! Make sure any equipment that is being installed or serviced is disconnected from all sources of power. In industry, it is important to have ‘Lockout and tagout’ procedures in place to make sure that power stays disconnected while people are servicing equipment. It is just as important in residential and commercial sites – DO NOT WORK ON LIVE EQUIPMENT UNLESS ABSOLUTELY NECESSARY!

Use the right tools for the job – do not improvise. For instance, use a proper fuse puller; don't use a screwdriver to pry out that open fuse.

Protect the person; use proper gloves, shoes, and

CAUTION INSTRUCTIONS FOR L&L KILNS

clothing. In industry it is recommended to wear safety goggles or face shields to prevent arc-flash or arc-blast injuries. Wear rubber soled shoes.

Make sure the environment around the equipment being serviced is safe. For instance, when working around electricity, it is always very dangerous for the floor to be wet. Make sure there is adequate space to work safely.

Be aware that current flow across your chest can be fatal. If possible, use only one hand to manipulate test leads when conducting any necessary measurements on live equipment. Use a clamp for one lead, and use one hand to guide the other test lead. Keep the other hand as far as possible from the live circuit components.

INSTALLATION CAUTIONS

USE A QUALIFIED ELECTRICIAN

1. Have electrical installation performed by a licensed electrician or other qualified technician.
2. There is danger of electric shock.
3. There is danger that an improperly sized or installed circuit could cause a fire.

CLEARANCES AND FLAMMABLE SURFACES

1. Make certain floor is not flammable.
2. Install kiln so that the hot surface of the kiln is no closer than 12" (30 cm) to any wall. 18" (46 cm) is preferable.
3. Be careful about enclosed spaces: In general, it is not a good idea to install a kiln in a small confined space (such as a closet).
4. Maintain a minimum of 36" (91 cm) between the hot surfaces of two adjacent kilns, especially if they are going to be used at the same time. (The kilns will heat each other).
5. The essential issue with kiln clearance is to keep excessive heat from flammable surfaces. Remember, even when you follow clearance and ventilation recommendations, the kiln is giving off heat. Try not to locate it near things that can be affected by elevated temperatures. An example of this would be an electrical

fuse panel which you do not want to overheat.

CHECK TEMPERATURES AROUND KILN

1. Check temperatures around the kiln when it is at high fire to be sure that you are not creating an unsafe condition.
2. Combustible surfaces that stay below 71°C (160°F) are generally considered safe from the point of view of starting a fire.

LEVELING THE KILN

1. Level the kiln while you are installing it.
2. Use thin metal shims under the legs to accomplish the leveling (never wood or other combustible materials).
3. Make sure that the base will not wobble.
4. Leveling is important because the kiln sitter (in manual kilns) is affected by gravity. If the kiln is not properly leveled the kiln sitter might be either too reactive or too sluggish.
5. You do not want your ware to be unstable in the kiln.
6. If kiln is not leveled this could lead to the cracking of the bottom and the top. In particular, the bottom could easily crack when you first set the weight of the kiln on the bottom while setting up the kiln for the first time.

ADJUSTING THE HINGE PROPERLY

1. See the assembly instructions for your specific kiln.
2. The hinge of any kiln must be adjusted so that the expansion caused by the heating process has room to expand.
3. An improperly adjusted hinge can damage the rim and/or lid but making the brick of the rim compress against the brick of the lid.

THERMOCOUPLES

1. Thermocouples (in automatic kilns) must be inserted into the kiln at least 1" (2.5 cm) in from the inside surface of the kiln.
2. They must protrude into the kiln itself because if the measuring tip of the thermocouple is buried inside the insulation the thermocouple will measure a lower temperature than the actual temperature in the kiln.

CAUTION INSTRUCTIONS FOR L&L KILNS

3. This could cause an overfire of the kiln.
4. Replace thermocouples once they are no longer reasonably accurate.

USE THE SUPPLIED KILN STAND

1. Do not use kiln without the supplied stand.
2. Never set a kiln on a floor without significant air space circulating under the kiln.
3. L&L stands typically raise the floor of the kiln by 8" (20 cm).

DON'T USE AN EXTENSION CORD

1. Never use an extension cord with your kiln.
2. Locate the outlet close enough to the kiln to plug directly into it with the kiln's supplied power cord.
3. Kilns that pull over 48 amps and some three phase kilns generally will not have a power cord. These kilns need to be indirect-wired in to the power supply.

POWER CORD MUST BE PROPERLY RATED

1. All L&L power cords are rated for 105°C (221°F).
2. Anything less than this can cause a malfunction and possible fire where the power leads connect to the control box.
3. It is OK, and will not void the warranty, to remove the plug that comes with the kiln and direct wire the kiln. However, the connection wires must be rated for a minimum of 105°C (221°F).

USE COPPER WIRE FOR HOOK UP

1. Do not use aluminum wire on the final connection to the kiln.
2. The specific reason particular to kilns is that the wire tends to get hotter near the kiln than it might going into some other types of appliance.
3. Being a resistive load, there is constant heat being generated by the conductors for quite a few hours. When aluminum wire gets hot it accelerates oxidation. Aluminum oxide is a resistor; copper oxide is not as much. If the connection at the terminal board gets oxidized it will really heat up - to the point where it could cause a fire.

4. Note: Depending on local codes it may be OK to use aluminum wire to your subpanel - as long as that wire is not exceeding its temperature rating while kiln is firing on full power for an extended period of time.

PROTECT POWER CORD FROM KILN CASE

1. Rout Power Cord (or electrical connection wires) away from kiln in such a way that it can not touch the hot case of the kiln.
2. Secure it so it can not move.
3. If cord touches the hot case it could melt and cause a short circuit and/or fire.

KEEP KILN DRY & IN PROTECTED SPACE

1. The kiln must be kept dry.
2. It is best to keep it in an enclosed room away from inclement weather. See specific details in the INSTALLATION INSTRUCTION section.
3. Note that our warranty does not cover damage from corrosion and electrical damage caused by inclement weather.
4. Water in contact with a kiln can cause an electrocution hazard.
5. If you keep a kiln outside (even in a very dry environment) and cover it with a tarp to protect it from rain you could still cause corrosion from the dew that forms on the cold metal surface of the kiln in the morning.

KEEP A FIRE EXTINGUISHER NEAR KILN

1. Keep an adequate fire extinguisher near the kiln and check it on a regular basis.
2. You may want to check with your local fire authorities to see if there are any specific requirements they have such as sprinkler systems, automatic foam extinguishers, etc.
3. Use a fire extinguisher that is rated for electrical fires (we recommend ABC rating).

SPRINKLER CAUTIONS

1. If you have a sprinkler system be careful to check the temperature rating and location of the heads so that you do not inadvertently cause them to actuate under

CAUTION INSTRUCTIONS FOR L&L KILNS

normal firing conditions.

2. Be sure to monitor this while the kiln is at its highest firing temperature and conditions are at their worse (for instance when the door to the kiln room is closed or the ventilation fan is turned off). Serious damage to the kiln and your premises can take place if the sprinkler system goes off when the kiln is at high temperature - especially if no one is in building when it happens.

GENERAL ENVIRONMENT CAUTIONS

VENTILATION IS ESSENTIAL

1. Kilns generate harmful fumes when firing ceramics.
2. Fumes include carbon monoxide, sulfur oxides, hydrogen fluoride and metal vapors (all of which can be very toxic).
3. Install kiln in well-ventilated area.
4. Never operate in an enclosed space such as a closet unless you have good ventilation.
5. Aside from issues of ventilating the fumes from the firing, the heat build up in an enclosed room could present a significant fire hazard. See the INSTALLATION cautions.
6. Severe corrosion can be caused by kiln fumes, salt air or other environmental conditions.
7. Good venting can minimize these problems.
8. Ventilation must be to the outside.
9. Be careful not to locate the outlet of the vent near an open window.

AMBIENT TEMPERATURES

1. The kiln should operate in an environment that is between -18°C (0°F) and 38°C (100°F).
2. Note that the control, if set up for degrees centigrade, may give you an error code if room temperature drops below 0°C (32°F). The DynaTrol and most other controls do not handle negative numbers.

SURFACE IS HOT AND CAN CAUSE BURNS

1. Kiln surface can be extremely hot: up to 260°C (500°F).

2. You can be severely burned if you touch the hot surface.

3. Display a sign near the kiln that specifically warns everyone of how hot the kiln is.

KEEP CHILDREN/ANIMALS AWAY FROM KILN

1. Protect any children, animals, and unqualified adults (anyone who is not able to understand these cautions) that may be near the kiln.
2. Aside from fumes that must be ventilated, and flammability concerns, they must be protected from the heat of the kiln and the electrical dangers.
3. Ideally, the kiln should be secured in a space away from any children (especially in a schoolroom situation where children might not always follow safety precautions).

KEEP FLAMMABLES AWAY FROM KILN

1. Do not put sealed containers or combustible materials such as solvents, paper, rags, in or near kiln.
2. An explosion or fire could result.

PRACTICE GOOD HYGIENE

1. Clay contains silica dust which can be harmful (see silica caution) and that many glazes contain heavy metals such as lead, cadmium and copper.
2. While this caution is outside the scope of kiln safety it is worth mentioning here.
3. Keep your room clean and your kiln clean.

TRIPPING HAZARDS

1. Be sure to remove tripping hazards near the kiln.
2. In particular be sure to keep the kiln cord out of traffic areas.

CLOTHING TO AVOID

1. When working around a hot kiln be careful of the kinds of clothes you are wearing.
2. Some clothes could potentially catch on fire if they touch the hot surface of a kiln.
3. Also avoid loose fitting clothes that could catch on the kiln.

CAUTION INSTRUCTIONS FOR L&L KILNS

PROPER USE OF KILN WASH

1. Make sure the floor of the kiln and the tops of the shelves are coated with kiln wash.
2. This will protect these surfaces from melting glaze and ceramics.
3. Do not coat the undersides or sides of the shelves.
4. Do not apply kiln wash to the brick sides or element holders. (Damage to the elements could result).
5. If you have a kiln sitter, put kiln wash on the cone supports (not the sensing rod) for accurate cone action.
6. Clean off the old wash and reapply new wash each time you fire or when it begins to chip away.

PREFIRING CAUTIONS

KILN WASH CONTAINS SILICA

1. Long term exposure to silica dust could cause lung damage.
2. See the MSDS sheets.
3. Exercise proper caution when mixing the dry powder and when removing it from your shelves.
4. Use a NIOSH approved particulate respirator for dust and use proper ventilation. You can buy these from safety supply houses. (NIOSH_approval #TC-21C-132 is an example).

DO NOT USE SILICA SAND

1. Do not use silica sand in the kiln.
2. Some people like to use this as a work support medium.
3. The silica sand will attack the elements and thermocouples.
4. It can migrate in the kiln from expansion and movement due to heat.
5. If you must use sand to support or stabilize your load try alumina oxide or zirconia oxide sand.

NEVER FIRE MOIST GREENWARE

1. Never load moist greenware or pots in your kiln.
2. The expanding water vapor in the ware could cause

the ware to explode, damaging your kiln interior.

3. We recommend using a dry out segment in your bisque program at 66°C (150°F). (Note that, because of the thermocouple offset programmed into our DynaTrol when we use the ceramic protection tubes, the display temperature will read 93°C (200°F) when the real temperature is 66°C (150°F)).

4. Remember that there may be water trapped in the work even if you can't always see it. If you place a piece of greenware next to your wrist and it feels cool to the touch it probably has too much moisture in it to fire.

CAUTION WITH USE OF WAX

1. When you heat wax (in wax resist and lost wax processes) it will volatilize and potentially condense in the cooler ventilation ducts.
2. Over time this can cause a fire hazard because the wax is flammable.
3. Depending on how the vent motor is mounted, the wax can also gum up the vent motor.
4. If you use these processes it is entirely up to you to engineer and monitor the safety of the installation.
5. The use of wax will void the warranty of the vent system.

DO NOT FIRE TEMPERED GLASS

1. Tempered glass can explode when fired.

STORE SHELVES IN A DRY LOCATION

1. Shelves can absorb moisture.
2. This can cause them to explode when fired.

DO NOT USE CRACKED SHELVES

1. Cracked shelves can fail in the middle of a firing causing the whole load in your kiln to collapse.

DO NOT FIRE TOXIC, FLAMMABLE, OR UNKNOWN MATERIALS

1. Plastics, organic materials, bakeable modeling clay, mothballs and a large variety of materials can decompose under heat causing the release of highly toxic fumes or rapid uncontrollable combustion.
2. Rocks, marbles, cement and other materials may

CAUTION INSTRUCTIONS FOR L&L KILNS

explode under high temperatures.

3. Before firing anything but ceramics, glass and metal (obtained from a known reputable source) in a kiln carefully investigate what happens under heat.
4. This is the sole responsibility of the user.
5. The kiln is not designed to be used for firing hazardous materials.

LOADING & UNLOADING CAUTIONS

TURN OFF POWER WHILE LOADING

1. Turn off power to the kiln when loading or servicing.
2. If power is on when you are loading or unloading the kiln it is possible to touch the elements and get electrocuted.
3. We recommend having the kiln attached to a fused disconnect switch with a lockout device (in any institutional or industrial installations where someone could turn on the kiln while someone else was working on it).

KEEP LID CLOSED WHEN KILN IS NOT IN USE

1. Keep lid closed when not operating the kiln.
2. Otherwise the weight of the lid over time may force the hinge and stainless wrap to move down.
3. This will affect the way the lid closes and may cause the lid to crack.
4. It will also keep the kiln cleaner by keeping dust out.
5. In addition, if the kiln somehow gets turned on accidentally, an open kiln could present a fire hazard.

DO NOT STORE ANYTHING ON LID

1. Do not use the lid as a storage shelf.
2. The lid could crack.
3. Also - this practice could lead to a fire if you accidentally leave combustible materials on the lid.

DO NOT OPEN THE DOOR ABOVE 250°F

1. Do not open the kiln door until the kiln has cooled down to 250°F (120°C).

2. You could burn your hand on the handle and/or the radiant heat from the kiln.

3. Be careful when you do open the door at this temperature because you can still get burned.
4. Use heat resistant gloves when opening the door. (These are available from L&L).

5. For ventilation purposes, some people fire with the lid slightly propped open 1" to 3" during the beginning phase of the firing (if they do not have a downdraft vent system). Be aware of the potential dangers of doing this (heat, live electricity, fumes and potentially cracking the lid) and take appropriate measures to protect yourself and the kiln.

DO NOT UNLOAD KILN WHILE HOT

1. You may burn yourself
2. You may harm your work.

BE CAREFUL OF SHARP OBJECTS

1. Stilt marks and other sharp protrusions can cut you.
2. Remember that that glaze is like glass.
3. Wear safety glasses while grinding or knocking of stilt marks.
4. Check the shelves for broken bits of glaze which may have attached to the shelves. These can be like shards of glass that can cause a serious cut.

SECURE LID WHILE LOADING OR UNLOADING IF YOU HAVE A SPRING-LOADED EASY-LIFT HINGE

1. Be sure to LOCK THE LID IN PLACE with the spring-loaded plunger pin located on the side of the hinge.

IF YOU HAVE A DAVINCI COUNTERBALANCED LID

1. Be sure to LOCK THE LID IN PLACE with the safety hooks when in the up position.
2. There is one on each side of a DaVinci kiln. Use both chains.

IF YOU HAVE A BASIC HINGE WITH CHAIN SUPPORTS

CAUTION INSTRUCTIONS FOR L&L KILNS

1. A special safety system is supplied with your Liberty-Belle, E18S, E18T, D18S, D18T, J18, or J18X kiln. This is a door safety chain.
2. It secures the lid in an open position when you are loading or unloading the kiln and insures that the lid can not accidentally come down on you. You must install and use this for your safety's sake.

This drawing shows the safety chain installation and use for the standard older Jupiter hinges.

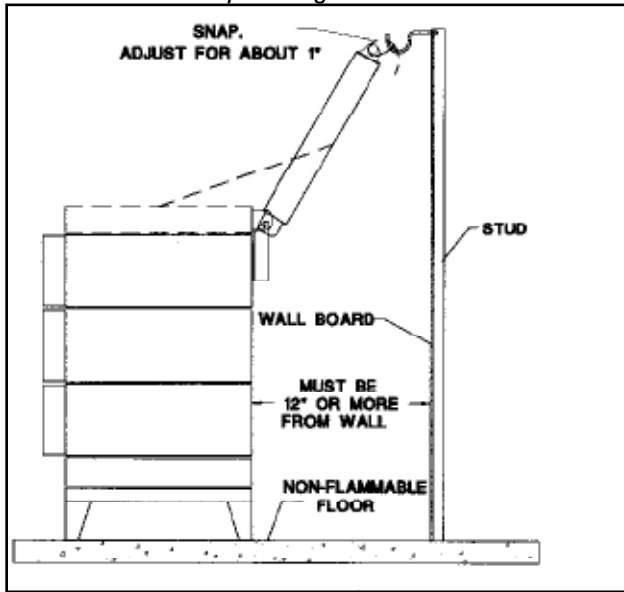

VIEWING INTO THE KILN

1. Use dark glasses (shade number 1.7 to 3.0) to view inside the kiln through the peepholes when firing. (These are available from L&L). These will protect you from the radiant infrared radiation and will also protect your eyes in case the ceramic ware explodes. Do not use regular sunglasses for this - they are not designed to protect your eyes from this type of radiation.
2. Use heat resistant gloves when opening peephole plugs. They are very hot and can burn you.
3. Do not open the kiln lid unless the kiln is turned off (except for carefully controlled troubleshooting tests). There is danger from electrocution. Cracks caused by propping open the lid are not covered by the warranty.
4. Use heat resistant gloves when opening a hot lid.
5. Do not open the lid when the kiln is above 121°C (250°F).

FIRING CAUTIONS

ATTEND THE FIRING

1. We recommend attending the kiln while firing.
2. NO AUTOMATIC SAFETY DEVICE IS FOOLPROOF! Be especially careful about attending the kiln when it is supposed to shut off. (The Delay feature in automatic kilns gives you control over this).
3. If you have a manual kiln with a Kiln Sitter PLEASE BE EXTRA CAREFUL! Kiln sitters can be very unreliable because of the moving parts, dirt or clay that can get into the tube, the way cones are placed on the tube, corrosion, etc. **DO NOT FIRE THIS KILN UNATTENDED WHEN THE KILN IS SUPPOSED TO TURN OFF AND LEARN HOW TO USE THE TIMER BACK UP.** Neither L&L Kiln Mfg., Inc. nor Edward Orton Jr. Ceramic Foundation warranty the kiln or kiln sitter against damage caused by overfiring. **ALMOST ALL OVERFIRED KILNS WE SEE ARE FROM A MISFUNCTION OF A KILN SITTER.** *We highly recommend firing all manual kilns with witness cones that you can see through the peephole and/or a pyrometer so you have some idea of what is happening inside the kiln.*
4. The controller is used to control temperature; it is not a safety device.

MAKE SURE YOUR KILN SITTER IS ADJUSTED

1. If you have a manual kiln (or the Kiln Sitter backup on an automatic kiln) be sure it is properly adjusted.
2. See the Kiln Sitter instructions.
3. Overfiring could result.
4. Note that the kiln sitter could have gone out of adjustment during shipment. Do NOT assume that it is adjusted when first firing the kiln.
5. The tube assembly should be replaced if gets overly corroded or contaminated with condensed glaze or other materials. Dawson recommended checking the pivot point for corrosion and sluggishness every 6 to 12 months.

USE KILN WASH ON THE CONE SUPPORTS

1. If you have a kiln sitter, put kiln wash on the cone support (but not the sensing rod) for accurate cone

CAUTION INSTRUCTIONS FOR L&L KILNS

action.

2. This will keep the cones from sticking when they bend.
3. We recommend cleaning off the old wash and reapply new wash each time you fire.

UNDERSTAND YOUR CONTROL

1. Become familiar with either the control (if you have an automatic kiln) or the Kiln Sitter (if you have a manual control or have that as your backup control).
2. Do this before operating the kiln.

PROGRAM REVIEW ON AUTOMATIC KILNS

1. Review the current program before firing to ensure the correct profile is programmed.
2. You may pick up an important mistake and save a whole load.
3. Hit Review Prog after you have done your programming and the control display will scroll through the program. It only takes a minute or less.

DO NOT CONFUSE CONE NUMBERS

1. Cone ratings are not intuitive. Cones with an "0" in front of them (like cone 05) are lower in temperature rating and the higher the number the lower the temperature rating. On the other hand cones with no "0" in front (like Cone 5) raise in temperature as the number gets higher.
2. For instance, Cone 05 is a much lower temperature than Cone 5 for instance. If you fire Cone 05 clay to Cone 5 you could cause a serious overfiring of the material which could melt in your kiln and cause severe damage to the kiln interior.
3. See the Orton cone chart.

USE THE PROPER THERMOCOUPLE

1. Never use a different type of thermocouple with your controller unless it has been set up from the factory.
2. For instance if you used a Type S thermocouple on a control set up for Type K you would overfire your kiln.
3. On some controls (like the newer DynaTrols) it is possible to change thermocouple types. However, this

involves both a programming change and a jumper change on the control. It also requires you to change out all the thermocouple lead wire to properly calibrated wire for the new thermocouple type.

CHECK THERMOCOUPLE CALIBRATION

1. Thermocouples will drift in reading over time.
2. This could potentially lead to an overfiring before the thermocouple actually fails.
3. Although you can not easily check thermocouple calibration, the general accuracy of the entire kiln system can be checked by firing with witness cones. See the LOG, CONES & CERAMIC FIRING section.

SHUT OFF KILN AT DISCONNECT OR CIRCUIT BREAKER

1. It is possible for electrical contacts on contactor relays to fuse together.
2. If this happens power will continue to flow to the elements and your kilns could overfire even though everything on the kiln is shut off.
3. You should turn kiln off from the circuit breaker or fused disconnect switch after turning off the kiln itself.

DO NOT FIRE KILN ABOVE 2350°F (1290°C, Cone 10)

1. Most L&L kilns are rated for use to 2350°F (1290°C, Cone 10).
2. The rating of the kiln is listed on its data nameplate normally affixed to the control panel.
3. DO NOT FIRE ANY HIGHER THAN THIS or hold for extended periods of time at those temperatures.
4. The elements, element holders and firebrick could melt.

POST FIRING CAUTIONS

CHECK FOR GLAZE AND CERAMIC CHIPS

1. Check element holders and walls for glaze, clay chips or anything that could melt at a high temperature.
2. If melted clay or glaze comes in contact with an element, a rapid failure could result. The molten

CAUTION INSTRUCTIONS FOR L&L KILNS

material traps the heat radiating from the element and subsequently raises the surface temperature of the wire. The temperature will quickly pass the maximum recommended temperature for the wire and burn it u

3. To clean holders, a good shop vacuum will handle dust and loose crumbs. A very gentle chisel or grinder may help with glaze contamination on element holders, but remember that the elements themselves are quite brittle when they are cool.

4. Replace the contaminated holder if you can not clean it.

5. Remove any glaze that has splattered on the firebrick or shelves. (USE SAFETY GLASSES WHEN DOING THIS BECAUSE GLAZE CAN BE LIKE BROKEN GLASS). Vacuum afterward. Note about vacuuming: it is possible to build up a strong static electricity charge when you are vacuuming. If this somehow manages to discharge into the control it can ruin the electronic circuit. Make sure vacuum is grounded and periodically touch some grounded metal surface away from the kiln to discharge the energy.

GENERAL MAINTENANCE CAUTIONS

ELECTRICAL SAFETY

1. Shut off kiln when servicing it. Use an approved lock out/tag out procedure to make sure that no one servicing the kiln gets injured or killed.

2. The elements carry high voltage and can electrocute you. Many of the tests described in the troubleshooting manual are performed under power. They should be done ONLY by someone who is familiar with electrical safety such as an electrician or trained maintenance person.

3. As long as the kiln is unplugged or turned off at the fused disconnect switch or circuit breaker (and checked with a reliable meter to be sure) you are safe.

CHECK WIRES & TERMINALS

1. Check wires for deterioration or oxidation.

2. Replace any that seem brittle or where the wire insulation has deteriorated or fallen off.

3. Check terminals for oxidation (discoloration).

4. If you are near salt air or if you notice corrosion on the stainless exterior of the kiln for whatever reason (like certain fumes generated by your work) then do this far more frequently.

5. Check power connection terminals in the kiln and control box for tightness. Be sure to do this with the power disconnected (unplugged) for the kiln. If these terminal connections get loose heat can be generated (because the electrical resistance gets greater) and this can cause a fire.

6. Check thermocouple connections for corrosion, tightness and oxidation as well. A bad thermocouple connection can change the accuracy of the temperature reading which could cause an overfiring.

CHECK TEMPERATURE OF CORD

1. Occasionally check temperatures of the main power cord at the main receptacle and the main kiln breaker while the kiln is at its hottest.

2. If these are hotter than normal, it could be a sign of a loose or corroded connection, or possibly the wire gauge used in the power hook-up is the wrong size for the amount of current being drawn by the kiln.

3. Immediately diagnose and fix this because it could cause a fire.

4. Also check temperature of any other cords on the kilns (such as element jumper cords).

CHECK FOR CORRODED CONNECTIONS

1. When replacing infinite zone switches (and other electrical components), replace the electrical connectors.

2. At the very least check for discoloration (an indication of oxidation).

3. Electrical connectors will typically oxidize over time where there is heat and this can cause further overheating of the part at the connection point. This can in turn lead to early failure of the part, wire and connector.

4. Make certain that the new connectors are firmly crimped onto the wire.

THE WRONG PARTS CAN BE HAZARDOUS

1. Non-L&L elements can present a potential hazard to

CAUTION INSTRUCTIONS FOR L&L KILNS

the kiln or cause a fire (by drawing too much amperage).

2. The wrong type of fuse, relay, switch or other component can cause a fire or other hazardous condition.
3. An improperly rated cord can cause a fire.

4. However, never wrap insulation around the perimeter of a typical sectional kiln.

5. You could trap heat in the wiring boxes and cause an electrical fire.

6. Also the stainless steel wrap that hold the kiln together will expand and loosen the structure of the kiln.

KILN MODIFICATIONS CAUTIONS

COATINGS

1. We can not at this time recommend any coatings for the elements.
2. Use of ceramic coatings will void the warranty on the elements and potentially the firebrick or element holders if it contaminates them.
3. Some people have reported success with ITC coating and some people seemed to have caused problems with this coating.
4. We have not adequately tested these coatings so we can only say, at this time, that any trouble that results from the use of ITC and other coatings must be at the risk of the user.
5. We do use a proprietary coating on all our firebrick that improves firebrick life and reduces dusting.

OTHER MODIFICATIONS

1. All customer modification is made solely at the risk of the customer.
2. Modifications will void the warranty.
3. L&L takes no responsibility for hazardous conditions created by unauthorized modifications.
4. Any authorization for an engineering change must be in writing from the factory.

DO NOT OVERINSULATE KILN

1. You may add insulation to the bottom, and to some extent the top.
2. If you put too much insulation on a lid it may weaken because it relies on the cooling of the lid to maintain its structural strength. This could lead to cracking or potentially a collapse of the lid.
3. See the various troubleshooting guides for information about this.

DURA-FIRE INSTRUCTION MANUAL



L&L Kiln's patented
hard ceramic
element holders
protect your kiln.

WARNING

1. Kiln Sitters can be very unreliable because of the moving parts, dirt or clay that can get into the tube, the way cones are placed on the tube, corrosion, etc.
2. DO NOT FIRE THIS KILN UNATTENDED WHEN THE KILN IS SUPPOSED TO TURN OFF AND LEARN HOW TO USE THE TIMER BACK UP.
3. FIRE THE KILN WITH WITNESS CONES AND/OR A PYROMETER SO THAT YOU KNOW WHAT IS GOING ON IN THE KILN.
4. Neither L&L Kiln Mfg., Inc. nor Edward Orton Jr. Ceramic Foundation warranty the kiln or kiln sitter against damage caused by overfiring.

FIRING INSTRUCTIONS FOR L&L MANUAL KILNS

CAUTION - USE THIS ONLY AS A STARTING POINT IN LEARNING THIS PROCESS

IMPORTANT NOTE: There are many kinds of loads fired in kilns with infinite variations. There is bisque firing, glaze firing, variations in clay bodies, variations in the wetness of the clay and, of course, many other kinds of firing like glass, crystalline glazes, various industrial processes, etc. This guide is meant ONLY as a starting point. Rely on your own experience and that of other people who know to compliment and expand on this starting point. Unfortunately we can not be your ultimate resource for firing information. If you have further questions please contact your local distributor, Orton Firing Institute or local pottery guilds or organizations.

TYPE OF SWITCHES

Zone Switches on L&L kilns come in two varieties; 4 position switches which have settings for Low, Med, High, and Off, but nothing in between, and Infinite Switches which have Off, then 1, 2, 3 through 11 ending at High - basically an infinite number of choices between Off and High. The 4 position switches were used on our old K Model and H & C Model kilns (typically before 1975). All J Series, Jupiter and DaVinci Series kilns use the Infinite Zone switches.

USE PYROMETRIC CONES

It is always wise to fire the kiln using self-supporting cones that melt at the temperatures your clays mature at, or a pyrometer, or some other way to tell the temperature in the kiln. As you load the kiln, place these cones so they can be seen easily through the peepholes.

PYROMETER SYSTEM

Consider using a Tru-View Pyrometer. This allows you to see what is happening in the kiln as it reaches maturity and allows you to adjust the manual switches with more precision.

ONE POTTER'S SUGGESTIONS

Set the kiln sitter up with one cone # hotter than your self-supporting cones.

If you have an automatic vent like the Vent-Sure use it. If not pop the lid open about 4 or 5 inches with

something non-flammable, and leave all the peephole plugs out. It is important to vent the water vapor and other fumes (such as carbon monoxide) that are generated in the beginning of the firing cycle. Glazes can also give off toxic fumes later in the firing cycle.

Turn on the Orton AutoCone Timer. The first time, turn it up very high, and keep track of how long the firing takes, the next time set it for about an hour longer than your first firing took.

Press the AutoCone's white button in so it stays in. Turn all the switches to Low or 1. Leave it that way for three hours if you think the clay was dry. Leave it for 8 to 20+ hours if the clay seems at all wet. On L&L Kilns switches have pilot lights next to them. On Low they may be on something like 7 seconds, and off 23 seconds in a 30 second cycle. The closer you turn the switches to High, the longer they will stay on, and the shorter they will stay off in that 30 second cycle. ('30 seconds' is not what it will actually be, but probably something close). When you get to High they will be on all the time.

Assuming the clay was dry, you have left it on for three hours, now, close the lid. Turn the top two switches to 5. Turn the bottom switch to 6.

As soon as you see Red Heat (any visible color) in the kiln, plug in the bottom two peepholes. Leave the top one open during the entire firing (if you don't have an automatic vent). If you do have a vent leave it on and keep the peephole plugged.

As soon as you see quite a bit of Red Heat (about 1400 Deg F if you have a pyrometer), turn the bottom two switches to High, and the top switch to 9. Check the cones you can see through each peephole often.

As you start to see movement in the cones, as their surfaces start to look runny, look closely to see that all three sections of the kiln are doing the same thing, at the same temperature top to bottom. You can fine-tune the switches now to add or subtract a bit of heat from the top or bottom to get to this point. As the cones all slump, turn all your switches off. Also if possible turn the electrical breaker off as well.

Wait for it to completely cool before opening it.

FIRING INSTRUCTIONS FOR L&L MANUAL KILNS

ANOTHER POTTER'S SUGGESTIONS

(For a bisque firing)

Put a ^08 into the kiln sitter, and prop the lid open with a 2" to 3" piece of softbrick. (using a hard post gouges the lid)

0:00: Put the bottom elements on LOW. leave the peepholes in (this prevents a chimney effect from cooling the front of the kiln.) Leave the bottom on LOW for 1 hour.

1:00 Put the middle elements on LOW. Now the bottom and middle are both on LOW. leave the kiln like this for one hour

2:00 hold a small mirror near the front of the open lid. if condensation appears, let the kiln go for another hour. If it does not, drop the lid.

3:00 turn the top element to LOW

4:00 turn all switches 1/3 of the way on (8:00 if you liken it to a clockface)

5:00 turn all the switches to 1/2 on (6:00 on a clockface)

6:00 turn all switches to 3/4 on (3:00 on a clockface)

7:00 turn all switches to HIGH. Dull red heat should begin to appear within the hour. When it does, set the timer on the AutoCone to 2 hours.

The kiln should shut off within that two hour period, most likely before the timer runs out.

This firing schedule has worked for the type of work I make on the wheel, my claybodies, the density that I load my kiln, and the dryness of the ware that I feel comfortable loading into the kiln. This is just an example of a typical firing schedule for me, and may need adjusting at different places depending on your own conditions.

INSTRUCTIONS FOR L&L DURA-FIRE MANUAL KILNS



TABLE OF CONTENTS

TABLE OF CONTENTS	1
CAUTIONS	1
INSTALLATION.....	1
TEMPERATURE RATINGS.....	2
PREPARATION & ASSEMBLY.....	2
UNDERSTANDING THE DESIGN	2
BASIC CONCEPT OF THE KILN.....	2
SECTIONAL CONSTRUCTION.....	2
REMOVABLE CONTROL BOX.....	2
STURDY ALUMINIZED STEEL STAND.....	2
SOLID STAINLESS STEEL CASE.....	2
"EASY-OPEN, EASY-LOAD" LID.....	2
STANDARD HINGE FOR SMALLER MODELS.....	2
THREE CASE CLAMPS PER SECTION.....	2
STAINLESS CLIPS HOLD BRICK LID IN PLACE.....	2
HEATING ELEMENTS IN CERAMIC HOLDERS.....	3
CHOICE OF 2-1/2" OR 3" OF INSULATION.....	3
LARGE DIAMETER PEEPHOLES.....	3
MANUAL CONTROL SYSTEM.....	3

ORTON AUTOCONE KILN SITTER/TIMER	3
OPTIONAL TRU-VIEW PYROMETER SYSTEM	3
REVERSIBLE BOTTOM.....	3
KILN FURNITURE	3
VENT-SURE VENT OPTION.....	3
POWER SUPPLY	3
VOLTAGE.....	3
WIRING DIAGRAM	3
WHY PROPER GROUNDING IS IMPORTANT.....	4
ELEMENT VOLTAGE.....	4
POWER HOOK UP.....	4
FUSING YOUR CIRCUIT.....	4
CONTROL SYSTEM.....	4
HIGH-MEDIUM-LOW ZONE SWITCHES.....	4
PILOT LIGHTS.....	4
KILN SITTER/TIMER.....	4
TESTING THE AUTOCONE FOR MANUAL KILNS.....	5
FIRST FIRING OF THE KILN.....	5
SERVICE AND MAINTENANCE	5
REGULAR KILN MAINTENANCE.....	5
REPAIRING OR REPLACING THE INSTRUMENT PANEL.....	5
REPLACING INFINITE ZONE SWITCHES.....	5
WARRANTY.....	6
SERVICE FOR YOUR KILN.....	6
TROUBLESHOOTING.....	6
ELECTRICAL SPECIFICATIONS.....	6
WHERE TO BUY PARTS.....	6
REPLACEMENT ELEMENTS.....	6
CRACKS IN THE TOP & BOTTOM.....	6
SPARE PARTS	6
WHERE TO BUY PARTS.....	6
PARTS TO KEEP ON HAND.....	6
PYROMETRIC CONES.....	6
WHERE TO LEARN MORE ABOUT CONES.....	6
FIRING LOG.....	6
MORE ABOUT FIRING CERAMICS.....	6

CAUTIONS

See the *cautions.pdf* in the CAUTIONS section. **READ THESE CAUTIONS.** They will help protect you and your property. Not all of the cautions are obvious - even experienced operators will need to pay attention.

INSTALLATION

See the INSTALLATION section (*install.pdf*) in this Instruction Manual. There is important information on electrical hookup, ventilation requirements, clearances, codes, etc. You must pay attention to these issues or you could create a dangerous situation.

INSTRUCTIONS FOR L&L DURA-FIRE MANUAL KILNS

TEMPERATURE RATINGS

The Dura-Fire kilns are rated for use to 2350°F (1287°C) (Cone 10). DO NOT FIRE ANY HIGHER THAN THIS. The elements, element holders and firebrick will melt. (Although the D28T kilns are only rated to go to Cone 5 or Cone 8 this is simply because of the lower power per square inch in that kiln; if you can get it to go above Cone 5 it won't hurt the kiln as long as you don't go above Cone 10).

PREPARATION & ASSEMBLY

See the ASSEMBLY section in this Instruction Manual for instructions on how to assemble your kiln. These are the assembly instructions for the Easy-Fire kilns which are very similar in assembly to the Dura-Fire kilns. Also see the first section of the CD/Video for Easy-Fire kilns.

UNDERSTANDING THE DESIGN

BASIC CONCEPT OF THE KILN

A Dura-Fire electric kiln is an insulated polygonal heating device designed specifically for firing of ceramics. Coiled elements made of a special high temperature alloy (iron-aluminum-chrome) are mounted around the perimeter of the kiln.

SECTIONAL CONSTRUCTION

The Dura-Fire kiln is made up of two or three separate sections that sit on top of a separate kiln floor. The are attached together by their control panel and hinge.

REMOVABLE CONTROL BOX

The control panel can be easily removed and sent to factory for repairs if ever necessary.

STURDY ALUMINIZED STEEL STAND

Aluminized steel resists corrosion at the high temperatures experienced in the important stand. The stand has a full plate of aluminized steel under the bottom brick. This allows the bottom brick to move freely while expanding and contracting - which helps prevent broken bottoms. The legs, which have two bends for stiffness, are bolted onto the stand plates. There are plastic feet that slip over the metal legs.

SOLID STAINLESS STEEL CASE

Resists corrosion and strengthens construction. Stainless steel screws are used throughout for long-term corrosion resistance.

“EASY-OPEN, EASY-LOAD” LID

The ‘Easy-Open, Easy-Load’ spring-assisted hinge is counterbalanced with a torsion spring which dramatically lightens the weight of the lid and makes it easy to open and close. A lighter lid also reduces lid and lip damage. A spring loaded safety latch holds the lid in place while loading. The lid, when open, is tilted away from the kiln opening allowing greater access to the interior. There are no lid supports in the way when loading your kiln. You can safely and easily load from both sides. Anyone who has tried to load a large kiln with a lot of work can fully appreciate this great feature. The hinge extends over three kiln sections and ties the kiln together for stability. All hinge parts are aluminized or galvanized steel for corrosion resistance. This is standard on the D28S and D28T models, optional on the D23S and D23T models and not available on the D18S and D18T models.

STANDARD HINGE FOR SMALLER MODELS

The standard hinge for the smaller models (D18S, D18T, D23S and D23T kilns) is made of stainless steel. You must use the provided safety chain system with these lids. (See *cautions.pdf* in the CAUTIONS section of your manual).

THREE CASE CLAMPS PER SECTION

The stainless steel case of each kiln section is held together by three adjustable stainless steel hose clamps. Behind the hose clamps the stainless steel case is reinforced with a piece of aluminized steel to prevent distortion. The clamps are easily accessible for adjustment. Two clamps are used on lids and bottoms.

STAINLESS CLIPS HOLD BRICK LID IN PLACE

Some manufacturers rely on the metal band around the kiln to hold the entire weight of the firebrick. L&L screws on several stainless steel clips that hold the firebrick in the band.

INSTRUCTIONS FOR L&L DURA-FIRE MANUAL KILNS

HEATING ELEMENTS IN CERAMIC HOLDERS

The heating elements are designed to have a low watt density (radiating watts per square inch of element surface area) and good stretch ratio (ratio of stretched length to original coiled length). These are supported in hard ceramic element holders (a unique L&L feature).

CHOICE OF 2-1/2" OR 3" OF INSULATION

The insulation is a special hand picked lightweight firebrick, which is 2-1/2" or 3" thick (depending on the model). This firebrick resists temperatures up to about 2450°F. It is highly insulating. The case temperature, when the kiln has reached final set point and the firebrick is saturated with all the heat it will absorb, can be several hundred degrees. After the heating elements are turned off the insulation will slowly lose its heat and the kiln and ware will cool down. (D28S and D28T kilns have 3" of brick as a standard feature).

LARGE DIAMETER PEEPHOLES

There is one 1" diameter peephole per section for ventilation and cone sighting. These are full diameter all the way through the firebrick, which allows greater visibility into kiln than with the tapered holes that are often used in other kilns. One ceramic peephole plug is supplied per hole.

MANUAL CONTROL SYSTEM

The manual control box has two or three high-medium-low zone switches. An Orton AutoCone kiln sitter/timer turns the kiln off when a pyrometric cone bends.

ORTON AUTOCONE KILN SITTER/TIMER

In addition, there is a AutoCone Kiln Sitter, which breaks power to either the whole kiln (on single phase models that are 50 amps or less) or power to the contactor coils. The kiln sitter uses a pyrometric cone to sense when you have reached your desired maximum temperature.

OPTIONAL TRU-VIEW PYROMETER SYSTEM

See *trueview-instruct.pdf* for more information.

REVERSIBLE BOTTOM

The brick bottom can be easily reversed in case of a firing mishap. (Not true for kilns with powered bottoms).

KILN FURNITURE

L&L supplies ceramic kiln furniture for all our kilns. See the catalog and price sheet for details about what is included.

VENT-SURE VENT OPTION

The Vent-Sure kiln ventilation system by L&L vents harmful fumes away from a kiln to the outside. Carbonaceous materials in clay, china paints and glazes containing oils, glue from decals, and certain glazes and other miscellaneous products generate fumes. Each vent is capable of handling 20 cubic feet of kiln. They can be easily added. See the separate installation and operation instructions (*ventsure-instruct.pdf*) in the VENT section.

POWER SUPPLY

VOLTAGE

Dura-Fire kilns are normally wired to work on either 240 Volt Single Phase, 208 Volt Single Phase (Some non-US kilns work on 220 Single Phase). It is important that the kiln be hooked up to the proper voltage. 208-volt kilns hooked up to 240-volt power supplies will generate too many amps. 240 volt kilns hooked up to a 208-volt power supply will heat up about 25% slower than they should and may not reach the higher temperatures. Although it is possible to hook a single-phase kiln to two legs of a three-phase supply it will cause an unbalanced load on your electrical supply. CHECK WITH A QUALIFIED ELECTRICIAN. In addition to the power wires there is, on all L&L kilns, a ground wire. The ground wire is not used as a neutral (i.e. no electricity normally flows through the ground). BE SURE TO GROUND THE KILN PROPERLY USING THE GROUND WIRE.

WIRING DIAGRAM

See your specific wiring diagram and data nameplate which has all electrical connection information for your kiln listed.

INSTRUCTIONS FOR L&L DURA-FIRE MANUAL KILNS

WHY PROPER GROUNDING IS IMPORTANT

All electrical appliances should be properly grounded. This can be to either a cold water pipe or proper system ground in your building. (NOTE: Grounding is normally provided in NEMA 6-50 type hook ups). If there is ever a short circuit (where the electricity flows through to the case or control panel and where you might touch it) you could be electrocuted if the kiln is not grounded. This is especially important with the high line voltage used on kilns. The higher the voltage the more easily it could flow through your body. In addition, because of the heat generated in a kiln, wires are subject to potential deterioration over time and expansion and contraction can move insulators and cause short circuits. **BE SURE TO REPLACE ANY DETERIORATED WIRES!**

ELEMENT VOLTAGE

The elements work on line voltage (208, 220 or 240 volts).

POWER HOOK UP

From the wiring diagram, have your electrician install the proper receptacle and safety switch at your kiln location. Note that L&L has available 50 Amp NEMA 6-50R receptacles from stock if you can't find them locally. Have receptacle placed in such a manner that the plug-in cord can in no way touch the body of the kiln. Be sure that your fuse ampere capacity is enough to carry the electrical load required. Also, ensure that your power lines are heavy enough to carry the required electrical load. If this is being used in an industrial application or environment be sure to follow lock out/tag out requirements and procedures. Be sure to ground kiln properly. **DO NOT USE ALUMINUM WIRE FOR HOOKING UP A KILN.**

FUSING YOUR CIRCUIT

The National Electrical says that you should fuse a resistance circuit (kilns are a resistive load rather than an inductive load like a motor) for 125% of their rated full load amps. The full load amps are listed on the data nameplate of the kiln. **CHECK WITH A QUALIFIED ELECTRICIAN.** See *volts.pdf* for a complete description of fuses.

CONTROL SYSTEM

HIGH-MEDIUM-LOW ZONE SWITCHES

Each section of the kiln has an input control switch provided on the instrument panel. This type of switch will give you high-medium-low control over the rate of speed of the firing. You can fire as slowly as you like, or as fast as the kiln is capable of attaining a certain temperature. When the switch is on low the two elements are switched to a series circuit. This cuts the voltage in half which essentially gives the circuit 1/4 of the the power. When the switch is turned to medium only one of the elements in on which provides 1/2 power. When the switch is turned to high the elements run on full power.

PILOT LIGHTS

There is a pilot light for each switch. This way you know when a switch is turned on.

KILN SITTER/TIMER

L&L Kiln Mfg. Inc. cannot assume any responsibility for a kiln sitter. We purchase this item. We install it, and supply you with the material to test it, prior to doing your regular firings. (All kiln manufacturers purchase the kiln sitter). It is a safety back up device; however, they can and do fail. L&L does not recommend unattended firings. See *cautions.pdf* in this OPERATION.

PUT KILN WASH ON THE CONE SUPPORT (NOT SENSING ROD) FOR ACCURATE CONE ACTION. CLEAN OFF THE OLD WASH AND REAPPLY NEW WASH EACH TIME YOU FIRE.

Read your Orton AutoCone Kiln Sitter manual **CAREFULLY AND COMPLETELY BEFORE USING YOUR NEW KILN.** This control is the shut-off system for your kiln, and must be properly set to prevent over-fire of your kiln. With your kiln you have received two (2) 020 test cones for the initial test. You do not have to use 020 cones for the test but these are the ones that are provided.

NOTE: The Timer must be set so that it is not on "0" (Off). If it is the AutoCone Kiln Sitter will not engage and the kiln will not turn on.

Be sure to read the section in the AutoCone instruction

INSTRUCTIONS FOR L&L DURA-FIRE MANUAL KILNS

book about Witness Cones. This is the most accurate method of determining temperature in the kiln.

TESTING THE AUTOCONE FOR MANUAL KILNS

In testing, you will use high heat only. When you are ready to test the kiln sitter, turn all of the switches to the highest point. The cone should go over within an hour, making the sitter cut off the kiln. An additional hour may be needed if you have a low voltage problem.

If, at the end of 2 hours, the kiln sitter has not turned off the kiln, turn it off manually. It probably needs an adjustment. Check the AutoCone kiln Sitter book for instructions on how to make this adjustment. Be sure to check the action of the kiln sitter against cones that you put in the kiln. Be sure to keep your firing gauge for future adjustment.

FIRST FIRING OF THE KILN

1) Insert the proper cone for a cone 5 test fire into the kiln-sitter tube inside the kiln, while holding the “trigger” under the “claw” on the outside of the kiln (as described in the AutoCone instruction manual.)

2) Set the kiln-sitter’s timer for the maximum time. Once you know how much time the kiln generally needs to fire you can set this timer closer to how long the kiln actually takes.

3) Press the “white button” in the middle of the “trigger” in. It should stay in. It will not stay in if the timer is on or close to zero, or if the “trigger” is not up. With the button in, power is allowed to pass through the Kiln-sitter to the control panel.

4) Turn on one or two switches to low for three hours. Then turn on all switches to low for two more hours to bake out any moisture. Then set to medium for three hours and then increase enough to reach final temperature. Fire it to cone 5 (approximately 2165°F).

SERVICE AND MAINTENANCE

REGULAR KILN MAINTENANCE

See *maintain.pdf* in the MAINTENANCE Section.

NOTE: Failure to properly maintain your kiln could

lead to a dangerous condition and could lead to premature aging of the kiln (like elements burning out).

REPAIRING OR REPLACING THE INSTRUMENT PANEL

The entire instrument panel is removable from the kiln. This is a unique L&L Kiln design feature and allows easy factory repair of your instrument panel. Disconnect power, unplug the kiln (if it has a plug), unplug all sections from the control box, disconnect the wires from the AutoCone kiln sitter (or physically remove the AutoCone kiln sitter from the furnace while keeping it attached to the panel), pack it carefully in a box with protective cushioning, and send it to L&L Kiln for inspection and/or repair. If your panel is hard wired then disconnect power, mark the wires and lugs where they come into the power connection board at the bottom of the control panel and remove the power wires. If the kiln is out of warranty there is still only a nominal charge for inspection (see the *part.pdf* in the PARTS section). Repairs will be quoted before any work is done. In addition complete instrument panels can be ordered for replacement.

REPLACING INFINITE ZONE SWITCHES

Often when a switch burns out it exhibits overheating on the switch body at one of the spade connectors. When this occurs the mating female connector on the wire may not give good electrical contact if reused (due to oxidation which acts an electrical insulator). a bad electrical connection can lead to localized heating at this point. To reduce the possibility of the new switch we recommend replacing the female connector with a new connectors. You may also need to replace the wires (check to see if they look oxidized or burnt). If the switch body looks O.K. then you normally do not need to replace the female spade connectors. To replace the female spade connector simply cut off the old connector with wire cutters, strip the end of the wire, insert the stripped end of the wire into the new female spade connectors and squeeze very tightly with a squeeze tool such as pliers or an electrical squeeze connector tool (available at the hardware store).

INSTRUCTIONS FOR L&L DURA-FIRE MANUAL KILNS

WARRANTY

Dura-Fire kilns carry a three year limited warranty. See *warranty.pdf* in the SERVICE Section.

SERVICE FOR YOUR KILN

See *service.pdf* in the SERVICE Section.

TROUBLESHOOTING

See the separate TROUBLESHOOTING SECTION.

ELECTRICAL SPECIFICATIONS

NOTE: You can get more information about the electrical specifications from *jupiter-ohms.pdf* (located in the TROUBLESHOOTING SECTION). This will give you resistance values for elements and kiln sections. Also see *jupiter-electric.pdf* for complete electrical specifications in the INSTALLATION section.

WHERE TO BUY PARTS

See *parts.pdf* in the PARTS Section.

REPLACEMENT ELEMENTS

See *parts.pdf* in the PARTS Section. Also see the *troubleshoot-elements.pdf* in the TROUBLESHOOTING Section.

CRACKS IN THE TOP & BOTTOM

It is quite normal to get hairline cracks in both the top and the bottom firebricks. They are caused by the expansion and contraction of the firebrick as it heats and cools. As long as the bottom is fully supported by the stand the cracks in the bottom will not adversely affect the operation of the kiln. Note that it is possible to put another bottom under the original bottom as a second layer (this can also improve performance and heat up rate of the kiln). It generally does not make sense to cement these hairline cracks.

SPARE PARTS

WHERE TO BUY PARTS

See *parts.pdf* in the PARTS Section.

PARTS TO KEEP ON HAND

If you are operating in a production environment it is imperative that you stock certain spare parts if you must prevent down time. While we do our best to ship parts quickly and to keep all parts in stock we cannot be responsible for your downtime. We recommend the following parts be kept on hand:

Complete set of elements

Complete set of fuses

One Zone Switch

One power contactor (on some kilns)

Jumper cable to element box

Several element holders

Brick Repair kit (See *brickrepair.pdf*)

PYROMETRIC CONES

See *the LOG, CONES & CERAMIC PROCESS* section.

WHERE TO LEARN MORE ABOUT CONES

Visit the Orton Website at *ortonceramics.com*. There is lots of great information on how to use cones and troubleshooting cone problems. See the Orton Cone Chart in the ORTON TIPS section. Note that the kilns tend to slow down considerably in the higher temperature ranges to 50°F to 100°F per hour.

FIRING LOG

We recommend keeping a firing log. Keep track of firing times, approximate load weight, firing temperatures and notes on results of the firing. There is a template in the LOG, CONES & CERAMIC PROCESS section of your instruction manual (*log.pdf*)

MORE ABOUT FIRING CERAMICS

See the sheet called *ceramic-firing.pdf* in the LOG, CONES & CERAMIC PROCESS section.

FIRST FIRING INSTRUCTIONS FOR L&L MANUAL KILNS

WHEN TO DO A FIRST TEST FIRING?

Once your kiln is set up, leveled properly (very important), control panel hooked up to the kiln correctly and all the power wired properly, you are ready for your first firing. Read these instructions and plan your time accordingly.

NOTE: This version is for kilns with a manual control panel and an Orton AutoCone kiln sitter/timer.

WHY DO A TEST FIRING?

The test firing is done very slowly, about 16 to 19 hours total to minimize the inner and outer surface temperature differences in the kiln while it goes through its maiden firing. Also this will slowly steam off any moisture absorbed by the firebrick during construction, shipping, and storage.

The test firing is done to cone 5 (about 2167°F) to vitrify the special coating on the inside on the firebrick and to allow an “aluminum oxide” coating to form on the element’s surfaces. The coating on the brick helps to reflect the heat radiated from the elements. The oxide layer on the elements helps to protect them from the many contaminants found in many materials fired in a kiln. This aluminum oxide layer will rejuvenate itself every time there is an oxygen rich firing to a high temperature. Going to cone 5 may also point out any problems with your electrical service - like low or incorrect voltage or wrong supply line wire size. The elements will also seat themselves in the ceramic holders - and any springiness you see when you first get your kiln will be alleviated.

NOTE: Normally bisquing is done to cone 05. Do not be confused by how the test firing uses SLOW BISQUE to cone 5, even though normally you would use a SLOW BISQUE to cone 05. The Slow Bisque program is used for the test firing BECAUSE is is a long program. We want this to be slow.

The test firing is done with the operator present as much as possible. This is to be sure the kiln is heating up safely, and that the heating kiln affects nothing else in the room or the room itself. As for the operator being present, logistically this may be difficult as the

test fire is designed to take about 16 to 19 hours. To deal with this a “Delayed Start” can be added to the test fire program, allowing you to press START at say 5PM, the kiln to start at say 8PM in order to turn off at 3PM the following day while you are there. More detail on this a little further on. You can also split it into two firings (see instructions at the end of this sheet).

The test fire is done with the kiln empty, or with the new kiln furniture. Anything else in the kiln (clay) will produce contaminants to some degree, and the elements in the kiln have not yet achieved this all important aluminum oxide coating before being subjected to these contaminants.

VENTING

Leave the Vent-Sure downdraft vent system on while the kiln is heating and cooling. Keep the peephole plugs in and the lid closed. If you have no vent system then leave the top peephole plug out during the first test firing.

NOTE: it is best for the evenness and speed of the firing to keep all the peepholes closed. However, for longevity of things like the elements, thermocouples, and kiln-sitter tube, as well as for better colors in clays and glazes, it is best to have as much air as possible moving through the kiln, without compromising the speed and evenness of the firing (this is a tradeoff). Open peepholes can be an OK way to vent, except that uneven drafts through the kiln can affect thermocouple readings, or “freeze” cones, leading to uneven firings or slow firings.

WHAT TO EXPECT

ELEMENT SMOKING

Brand new elements will smoke a little initially the first time they are heated. A fan in a window is more than adequate to deal with this. If you have the Vent-Sure vent on this should also be adequate.

NOISES IN A KILN

Hum. Whenever kiln elements come on they are accompanied by a humming sound from electricity in the elements. This is normal. The natural properties of electricity and the dynamics of the shape of the

FIRST FIRING INSTRUCTIONS FOR L&L MANUAL KILNS

element combine to make a slight vibration in the element.

WHAT HAPPENS AS THE KILN HEATS UP

All the materials used in the kiln's construction expand incrementally as they are heated. First the inside materials- i.e. the elements, holders, and inside surfaces of the walls, floor, and lid heat and expand slightly. Then, the heat moves slowly through the walls, lid and floor until it begins to heat the outer surface of the kiln. The greater the difference in temperature is between the inside surface vs. outside surface, the more stress there is on the material itself. Walls, lids and floors can sometimes hairline-crack on the surface or in the some cases, all the way through. Really this is normal and to be expected sooner or later to some degree. If you tighten the stainless steel bands that surround the floor, lid, and walls of the kiln every so often, the fact that the firebrick expands as it heats will mean that the cracks are actually closing up while the kiln is heating, expanding against the cooler outer shell. The geometry of the kiln and the tightness of the stainless steel bands are what holds everything together, whether the brick is in a few pieces or all one piece should not matter a whole lot, although cracked floors should be fully supported as they are with our full-support stands. See the *maintain.pdf* in the MAINTENANCE section and *troubleshoot-brick.pdf* in the TROUBLESHOOTING section for more information.

VISIBLE RED HEAT

Another thing to expect is to see the "red heat" through the seams, between the sections of the kiln, beginning around 1000°F. This is normal. The seam between the lid and the top section will probably appear the largest. This is partly because, when the top heats up, it becomes slightly concave and the edge lifts up.

IMPORTANT NOTE: It is VERY important for this gap between the lid and the rest of the kiln to be even all the way around throughout the firing. If it is more open in the front when hot, then the hinge is out of adjustment and must be raised up. Your kiln's Assembly instructions detail the hinge adjustment. The danger of this condition is that all the weight of the lid is now resting on the inner upper edge of the back firebricks on the top section. They will crack off

in a firing or so and probably damage the lid too.

The outer metal and brick surfaces of the kiln will get very hot, as hot as 450°F - easily hot enough to burn you.

The interior of the kiln will look white hot at the highest temperatures. CAUTION: Be sure to always use kiln safety glasses when looking through the peepholes to protect your eyes from infrared radiation.

MANUAL KILNS: STEP BY STEP

- 1) Insert the proper cone for a cone 5 test fire into the kiln-sitter tube inside the kiln, while holding the "trigger" under the "claw" on the outside of the kiln (as described in the AutoCone instruction manual.)
- 2) Set the kiln-sitter's timer for the maximum time. Once you know how much time the kiln generally needs to fire you can set this timer closer to how long the kiln actually takes.
- 3) Press the "white button" in the middle of the "trigger" in. It should stay in. It will not stay in if the timer is on or close to zero, or if the "trigger" is not up. With the button in, power is allowed to pass through the Kiln-sitter to the control panel.
- 4) Turn on one or two switches to low for three hours. Then turn on all switches to low for two more hours to bake out any moisture. Then set to medium for three hours and then increase enough to reach final temperature. Fire it to cone 5 (approximately 2165°F).

DURA-FIRE INSTRUCTION MANUAL

LOG, CONES, TIPS,
CERAMIC PROCESS

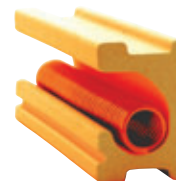

L&L Kiln's patented
hard ceramic
element holders
protect your kiln.

Temperature Equivalent Chart for Orton Pyrometric Cones (° F) Cone Numbers 022-14



Cone	Self Supporting Cones						Large Cones			Small
	Regular		Iron Free		Heating Rate ° F/hour (last 180° F of firing)		Regular	Iron Free	Regular	Regular
	27	108	270	27	108	270	108	270	108	270
022										540
021	1087	1112	1143				N/A	N/A		1166
020	1159	1180	1180				N/A	N/A		1189
019	1213	1252	1283				1249	1279		1231
018	1267	1319	1353				1314	1350		1333
017	1301	1360	1405				1357	1402		1386
016	1368	1422	1465				1416	1461		1443
015	1382	1456	1504				1450	1501		1517
014	1395	1485	1540				1485	1537		1549
013	1485	1539	1582				1539	1578		1598
012	1549	1582	1620				1576	1616		1616
011	1575	1607	1641				1603	1638		1652
010	1636	1657	1679	1600	1627	1639	1648	1675	1623	1636
009	1665	1688	1706	1650	1686	1702	1683	1702	1683	1699
008	1692	1728	1753	1695	1735	1755	1728	1749	1733	1751
007	1764	1789	1809	1747	1780	1800	1783	1805	1778	1796
006	1798	1828	1855	1776	1816	1828	1823	1852	1816	1825
05½	1839	1859	1877	1814	1854	1870	1854	1873	1852	1868
005	1870	1888	1911	1855	1899	1915	1886	1915	1890	1911
004	1915	1945	1971	1909	1942	1956	1940	1958	1940	1953
003	1960	1987	2019	1951	1990	1999	1987	2014	1989	1996
002	1972	2016	2052	1983	2021	2039	2014	2048	2016	2035
001	1999	2046	2080	2014	2053	2073	2043	2079	2052	2070
1	2028	2079	2109	2046	2082	2098	2077	2109	2079	2095
2	2034	2088	2127				2088	2124		
3	2039	2106	2138	2066	2109	2124	2106	2134	2104	2120
4	2086	2124	2161				2120	2158		
5	2118	2167	2205				2163	2201		
5½	2133	2197	2237				2194	2233		
6	2165	2232	2269				2228	2266		
7	2194	2262	2295				2259	2291		
8	2212	2280	2320				2277	2316		
9	2235	2300	2336				2295	2332		
10	2284	2345	2381				2340	2377		
11	2322	2361	2399				2359	2394		
12	2345	2383	2419				2379	2415		
13	2389	2428	2458				2410*	2455*		
14	2464	2489	2523				2491*	2530*		

Pyrometric cones have been used to monitor ceramic firings for more than 100 years. They are useful in determining when a firing is complete, if the kiln provided enough heat, if there was a temperature difference in the kiln or if a problem occurred during the firing.

Cones are made from carefully controlled compositions. They bend in a repeatable manner (over a relatively small temperature range - usually less than 40° F). The final bending position is an indication of how much heat was absorbed.

Behavior of Pyrometric Cones

Typically, it takes 15 to 25 minutes for a cone to bend once it starts. This depends on the cone number. The cone bends slowly at first but once it reaches the half way point (3 o'clock), it bends quickly. When the cone tip reaches a point level with the base, it is considered properly fired. This is the point for which temperature equivalents are determined. Differences between a cone touching the shelf and a cone at the 4 o'clock position are small, usually 1 or 2 degrees.

Temperatures shown on the charts were determined under controlled firing conditions in electric kilns and an air atmosphere. Temperatures are shown for specific heating rates. These heating rates are for the last 100° C or 180° F of the firing. Different heating rates will change the equivalent

temperature. The temperature will be higher for faster heating rates and lower for slower heating rates.

Cone bending may also be affected by reducing atmospheres or those containing sulfur oxides. Orton recommends the use of Iron-Free cones for all reduction firings (cones 010-3). If a cone is heated too fast, the cone surface fuses and binders used to make cones form gases that bloat the cone. If cones are to be fired rapidly, they should be calcined (pre-fired) before use. Cones should be calcined to about 850° F (455° C) in an air atmosphere.

If a cone is soaked at a temperature near its equivalent temperature, it will continue to mature, form glass and bend. The time for the cone to bend depends on several factors and as a general rule, a 1 to 2 hour soak is sufficient to deform the next higher cone number. A soak of 4 to 6 hours will be required to deform two higher (hotter) cones.

for more information on pyrometric cones, contact Orton or visit us at www.ortonceramic.com



The Edward Orton Jr. Ceramic Foundation
 P.O. Box 2760 • Westerville, OH 43086-2760
 (614) 895-2663 • (614) 895-5610 fax
info@ortonceramic.com
www.ortonceramic.com

These tables provide a guide for the selection of cones. The actual bending temperature depends on firing conditions. Once the appropriate cones are selected, excellent, reproducible results can be expected. Temperatures shown are for specific mounted height above base. For Self Supporting - 1 3/4"; for Large - 2"; for Small - 1 5/16". For Large Cones mounted at 1 3/4" height, use Self Supporting temperatures. * These Large Cones have different compositions and different temperature equivalents.

Temperature Equivalent Chart for Orton Pyrometric Cones (°C) Cone Numbers 022-14



Cone	Self Supporting Cones						Large Cones			Small	
	Regular			Iron Free			Regular			Iron Free	
	Heating Rate °C/hour (last 100° C of firing)										
	15	60	150	15	60	150	60	150	60	150	300
022		586	590				N/A	N/A			630
021		600	617				N/A	N/A			643
020		626	638				N/A	N/A			666
019	656	678	695				676	693			723
018	686	715	734				712	732			752
017	705	738	763				736	761			784
016	742	772	796				769	794			825
015	750	791	818				788	816			843
014	757	807	838				807	836			870
013	807	837	861				837	859			880
012	843	861	882				858	880			900
011	857	875	894				873	892			915
010	891	903	915	871	886	893	898	913	884	891	919
009	907	920	930	899	919	928	917	928	917	926	955
008	922	942	956	924	946	957	942	954	945	955	983
007	962	976	987	953	971	982	973	985	970	980	1008
006	981	998	1013	969	991	998	995	1011	991	996	1023
05½	1004	1015	1025	990	1012	1021	1012	1023	1011	1020	1043
005	1021	1031	1044	1013	1037	1046	1030	1046	1032	1044	1062
004	1046	1063	1077	1043	1061	1069	1060	1070	1060	1067	1098
003	1071	1086	1104	1066	1088	1093	1086	1101	1087	1091	1131
002	1078	1102	1122	1084	1105	1115	1101	1120	1102	1113	1148
001	1093	1119	1138	1101	1123	1134	1117	1137	1122	1132	1178
1	1109	1137	1154	1119	1139	1148	1136	1154	1137	1146	1184
2	1112	1142	1164				1142	1162			1190
3	1115	1152	1170	1130	1154	1162	1152	1168	1151	1160	1196
4	1141	1162	1183				1160	1181			1209
5	1159	1186	1207				1184	1205			1221
5½	1167	1203	1225				1201	1223			N/A
6	1185	1222	1243				1220	1241			1255
7	1201	1239	1257				1237	1255			1264
8	1211	1249	1271				1247	1269			1300
9	1224	1260	1280				1257	1278			1317
10	1251	1285	1305				1282	1303			1330
11	1272	1294	1315				1293	1312			1336
12	1285	1306	1326				1304	1324			1355
13	1310	1331	1348				1321*	1346*			N/A
14	1351	1365	1384				1366*	1388*			N/A

Pyrometric cones have been used to monitor ceramic firings for more than 100 years. They are useful in determining when a firing is complete, if the kiln provided enough heat, if there was a temperature difference in the kiln or if a problem occurred during the firing.

Cones are made from carefully controlled compositions. They bend in a repeatable manner (over a relatively small temperature range - usually less than 40° F). The final bending position is an indication of how much heat was absorbed.

Behavior of Pyrometric Cones

Typically, it takes 15 to 25 minutes for a cone to bend once it starts. This depends on the cone number. The cone bends slowly at first but once it reaches the half way point (3 o'clock), it bends quickly. When the cone tip reaches a point level with the base, it is considered properly fired. This is the point for which temperature equivalents are determined. Differences between a cone touching the shelf and a cone at the 4 o'clock position are small, usually 1 or 2 degrees.

Temperatures shown on the charts were determined under controlled firing conditions in electric kilns and an air atmosphere. Temperatures are shown for specific heating rates. These heating rates are for the last 100° C or 180° F of the firing. Different heating rates will change the equivalent

temperature. The temperature will be higher for faster heating rates and lower for slower heating rates.

Cone bending may also be affected by reducing atmospheres or those containing sulfur oxides. Orton recommends the use of Iron-Free cones for all reduction firings (cones 010-3). If a cone is heated too fast, the cone surface fuses and binders used to make cones form gases that bloat the cone. If cones are to be fired rapidly, they should be calcined (pre-fired) before use. Cones should be calcined to about 850° F (455° C) in an air atmosphere.

If a cone is soaked at a temperature near its equivalent temperature, it will continue to mature, form glass and bend. The time for the cone to bend depends on several factors and as a general rule, a 1 to 2 hour soak is sufficient to deform the next higher cone number. A soak of 4 to 6 hours will be required to deform two higher (hotter) cones.

For more information on pyrometric cones, contact Orton or visit us at www.ortonceramic.com



The Edward Orton Jr. Ceramic Foundation
 P.O. Box 2760 • Westerville, OH 43086-2760
 (614) 895-2663 • (614) 895-5610 fax
 info@ortonceramic.com
 www.ortonceramic.com

These tables provide a guide for the selection of cones. The actual bending temperature depends on firing conditions. Once the appropriate cones are selected, excellent, reproducible results can be expected. Temperatures shown are for specific mounted height above base. For Self Supporting - 1 3/4"; for Large - 2"; for Small - 1 5/16". For Large Cones mounted at 1 3/4" height, use Self Supporting temperatures. * These Large Cones have different compositions and different temperature equivalents.

TROUBLESHOOTING KILN FIRING WITH CONE PACKS

BASIC CONE INFORMATION

PYROMETRIC CONES

Pyrometric cones are made of clay and other minerals and are precisely formulated to soften when fired in a kiln. They will bend over when they have absorbed a certain amount of heat. The amount of heat is related to both time and temperature. They mirror fairly accurately what goes on in ceramic body and so can be a more reliable guide to firing than a thermocouple instrument. Differing materials in the cones result in different firing temperatures. The cones you are likely to use in an L&L kiln are numbered from Cone 022 to Cone 10 (coldest to hottest). The number is imprinted on the cone. Usually clay and glaze comes with a recommended cone to fire to. A cone is a tall (about 2-1/2") pyramid made from specific damp-pressed ceramic materials. Each cone has a slight lean to it when placed on a flat surface. Be careful not to drop or expose to moisture your cones.

CONES MEASURE HEAT-WORK

Cones are not temperature measuring devices. They measure how much heat has been absorbed by the ware in the kiln, which is the result of the combination of time and temperature. A particular piece of clay needs a certain amount of time at a specific temperature to properly fire it, lower temperature if the time is longer, higher temperature if the time is shorter. An example of this would be if you added about a 20 minute hold to the maximum temperature of a cone 6 firing, you would be able to lower that final temperature by about 20°F. An hour hold time would mean a final temperature of about 40°F lower. A two hour hold time, about 60°F lower.

LARGE SELF SUPPORTING CONES

Although there are various types of cones available we recommend using the "self-supporting large cones". They have a built-in base that allows the cone to sit flat while always placing the pyramid part of it at the proper angle. The angle is there to ensure that the cone bends in the direction you want it to, and doesn't just slump and puddle.

CONES FOR DAWSON KILN SITTERS

There are "small cones" and "bars" available for use in kiln-sitters and in automatic shut-off devices. Small cones are shaped like standard cones but are only about 1" long. They are meant to melt in the kiln-sitter mechanism and activate the shut-off device. The "bars" make it easier for them to be placed properly in the mechanism, as the cones are tapered, and improper placement can result in a slight over-fire or under-fire of the ware. These cones should never be expected to mimic the results of standard or self-supporting cones unless they are used in the kiln-sitter. Gravity works differently on them because their physical size is smaller, and therefore they will melt at a considerably higher temperature than a large cone of the same cone number when they are placed side-by-side.

CONE PACKS

The best way to use the cones, especially if they are all you have to tell how hot your kiln is getting, is to use 'cone packs', or the three cone system. The three cones are placed in a line, aimed so that when they fall, they will fall in a line. The first cone to fall should be in the front of the three cone line. This cone should be one cone number lower than the one you wish to fire to. The target cone (the cone you wish to fire to) should be the next one to fall and should be in the middle. The last cone should be one cone number higher than the target cone. The first cone is to warn you that the firing is almost done. The target cone tells you when to turn off the kiln, and the last cone tells you if the kiln got hotter than you thought it did.

Picture of a "cone pack" (Courtesy of Orton). The ones in the back are before the firing and the ones in the front are after a perfect firing/ These are Self-Supporting Large Cones.



TROUBLESHOOTING KILN FIRING WITH CONE PACKS

USE CONES TO CONTROL ACCURACY IN AN AUTOMATIC KILN

We recommend checking the accuracy of your control and thermocouples every so often by placing at least one large cone (the target cone or cone number you are firing to) in the top, middle and bottom. Thermocouples will drift in their accuracy, but you can adjust the cone offset or thermocouple offset (or both) to compensate for this. You know how many degrees off the thermocouple reads at the end of the firing. Using a cone near the thermocouple and a “cone to temperature chart” will help to calibrate a thermocouple accurately. Remember though, cone temperatures are affected by their location in the kiln, the angle at which they are held, and the rate at which they are heated. Slight variations throughout the kiln should be expected.

CONE CHART

You can see a “cone to temperature” chart in the LOG, CONES, TIPS, CERAMIC PROCESS section of your manual. There is far more detailed information on this on the Orton web site (ortonceramics.com).

TROUBLESHOOTING FIRING PROBLEMS

Seems like the kiln is under-firing or over-firing slightly

1) On the next firing make up “cone packs”, one for each thermocouple. A cone pack is a set of three cones, standing in a line. The cone the firing should go to is called the target cone, and is in the middle. The one in front of it is one cone number lower, and the one behind it is one cone number higher. Pay attention to how you position the cones as they are designed to only fall in one particular direction if placed on a level surface. You do not want a lower-numbered cone stuck in the cone pack behind a higher-numbered cone because the lower-numbered one will fall first and might lean against or knock over the higher-numbered cone, which will compromise the accuracy of both cones.

2) Once the cone packs are positioned on shelves (or on a post lying on its side) and are visible through the peepholes, fire the kiln to the middle cone's number.

3) Near the end of the firing start watching the cone packs. Look for the first cone to fall over in each pack, not necessarily at the same time, but pretty close, probably in the middle zone first.

4) Now watch for the middle cone in each pack. Keep checking the DynaTrol display to be sure it does not say **CPLt**. The middle cone in each pack should start to fall at pretty much the same time in the top, middle and bottom of the kiln. When the tip of the cone touches the melted cone in front of it note the temperature readout on the display for that zone's thermocouple.

a) If the middle cones did not go down together then immediately note the differences in each thermocouple reading from the one thermocouple in the same zone as the first cone that went down. Later on, use the “thermocouple offset” feature to add or subtract degrees from each thermocouple accordingly. Use the differences between the thermocouple readings as a guide to know how much to offset each thermocouple.

b) If the three thermocouple temperatures are close enough to be reading the same thing (the middle cones did all go over at the same time), then the kiln should say **CPLt** right when the cone tips bend over and touch or just before it. If the kiln is still firing after this point, note how many degrees higher it goes before shutting itself off. Then use the “cone offset” feature to change the temperature equivalent of that cone. Subtract the same amount of degrees from the temperature equivalent that the kiln over-fired the cone by.

c) If the kiln shut itself off before bending the cones properly, you want to reprogram it and then re-start it as quickly as possible. Note the temperature at which the kiln shut down. Get from **CPLt** to **IdLE**, **tC 2**, current temperature by pressing either **START/STOP** or **ENTER**. Re-program the same program to one cone number higher, then re-start the firing. Do these steps quickly. Now watch the middle

TROUBLESHOOTING KILN FIRING WITH CONE PACKS

cones again and note at what temperature the cones properly bend. If they bent while you were programming then just offset the temperature by 5 or 6 degrees. Shut the kiln off once you note that temperature. Using the “cone offset” feature, add the difference of the two readings to that cone's temperature equivalent.

Note: From the factory, the settings that interpret temperature signals in the DynaTrol are hard-programmed; they will not change unless part of the microprocessor has been affected. There is a range of acceptability for the accuracy however and the cone offset feature exists to allow you to fine tune the kiln to particular sized loads. It is best to use all new thermocouples to properly tune the cone offset before individual thermocouples begin to drift. Even keeping one new thermocouple solely for calibrating the individual thermocouples will help to keep the kiln accurate.

CALIBRATING YOUR DYNATROL

This is also covered in the instruction sheet called *dynatrol-basic-operation.pdf* in the OPERATION section of your manual (if you have an automatic kiln).

MORE INFORMATION

Orton Ceramic Institute

See ortonceramics.com for lots of very helpful information on how to use cones and for many firing tips and great information on firing kilns. (ortonceramics.com)

You can see a “cone to temperature” chart in the LOG, CONES, TIPS, CERAMIC PROCESS section of your manual.

What Cone Numbers Mean: Why You Should Care

The pyrometric cones used today by ceramic artists and industrial manufacturers were developed in the late 1800's by Edward Orton Jr. Dr. Orton recognized that ceramists needed a way to determine when their ware was fired correctly to develop the properties they required in their finished products. Thus all ceramic products were assigned a cone number to which they were to be fired to assure maturity of the ware during the firing process such as Cone 06 glazes, Cone 04 bodies, etc. Later, the development of electronic temperature controllers simplified the control of the firing process, but they could not replace the cones as a measure of the accumulative effect of time and temperature on the ceramic ware. An interesting parallel to this principle would be the cooking of a turkey in your electric oven. You can set the oven temperature to 350 degrees Fahrenheit and place the turkey in the oven and estimate how long to cook it to attain an internal temperature of 180 degrees Fahrenheit. However if you want to be assured the turkey reaches the desired internal temperature you can place a meat thermometer into the turkey and it will tell when you have reached the desired internal temperature. Changing the oven temperature will surely effect the time required to reach the desired internal temperature. Cones serve a similar purpose in the firing of ceramics.

Both the Orton and the Bartlett electronic temperature controllers' cone-fire programs were developed based on the actual firing behavior of Orton cones and would not work without the information on cone behavior provided by the Orton Ceramic Foundation. These controllers automatically adjust the final firing temperature based on the actual heating rate of the kiln so that the kiln delivers the correct amount of heat work specified by the cone number program selected. Therefore the most efficient and reliable way to fire your kiln is to utilize the cone-fire programs built into your controller.

However, the electronic controller is not the ultimate answer for assurance that your ware has been fired correctly. The electronic controller measures the temperature inside the kiln via the thermocouple that is usually mounted in the side wall of the kiln and extending into the kiln 1 to 1½ inches. The thermocouple is great for measurement of temperature at a point in space and a point in time and provides the controller feedback needed to control the firing cycle. But heat work is a function of both temperature and time as measured by the bending of pyrometric cones.

Why is it so important to know if you have attained the correct cone firing? Look at the label on your glaze jar. The odds are that the glaze is specified as a "Cone X" glaze. The unstated instruction for firing such a glaze is to "apply heat work equal to the cone number specified and the glaze will be properly matured". The glaze manufacturer has developed the glaze formula to mature at a certain cone number. The glaze manufacturer has conducted sufficient testing to know the fired characteristics of the mature glaze as related to glaze fit to the body, color development, the chemical resistance of the glaze surface, food-safe, etc. Under-firing or over-firing can prevent the glaze from attaining the appearance and properties you expect.

Since the thermocouple and the controller do not measure heat work how do you know if you actually matured the glaze in every firing? The thermocouple measures the temperature near the wall of the kiln where the heating elements are located and unfortunately has no means of measuring the temperature within the setting of the ware in the kiln and therefore cannot confirm if the distribution of heat work was uniform throughout the kiln. Remember the turkey story? One could fire the kiln with such a long firing cycle that all areas within the kiln received the desired

amount of heat work, but this practice could require additional kilns to meet firing needs and the energy consumption would be wasteful. A definite overkill approach without merit. The programmable controller, coupled with the use of pyrometric cones, allows for the development of firing profiles to meet all your firing conditions. Since most shop operators want to have their kiln fully utilized during each firing, we will consider a fully loaded kiln of glazed ware to be fired to cone 06. The load placed in the kiln has a direct bearing on the firing profile required to successfully fire your ware. Select the cone-fire program consistent with the recommendation of the glaze manufacturer, in this case cone 06. Remember that selecting a cone-fire program alone does not insure that you will obtain uniform heat distribution throughout your ware. The controller is designed to compensate if the kiln is heating slower than the expected rate, but only at the tip of the thermocouple, it has no information about what is occurring in the interior of the ware setting. Place a series of three cones, 07, 06, 05 (self-supporting cones are the most convenient to use) one series located on the outside perimeter of the ware setting, and the second series located in the center of the ware setting on each shelf in the kiln (commonly referred to as "witness cones"). Fire the kiln. Once cool, remove the cones marking their location in the kiln. If the cone 06 is bent so that the tip is at the same level as the top of the foot of the cone in all locations, congratulations, you have just achieved a successful firing to cone 06. **See Figure 1.**



Cone 05 Cone 06 Cone 07
Figure 1. Cone 07 is over-fired and cone 06 indicates a successful cone 06 firing.

If some of the locations indicate that you did not reach cone 06, the tip of cone 06 is not bent enough, you will need to modify your firing cycle on your controller. By having cone 07 along side cone 06 you can determine by how much you failed to reach a cone 06 firing. Cone 07 measures a lesser amount of heat work than cone 06, therefore if cone 07 is bent so that the tip is at the same level as the top of the foot of the cone you are only one cone away from the desired heat work. **See Figure 2.** There are two simple ways to correct poor heat distribution within your kiln. First, for your cone-fire program if you selected either *fast*(#1) or *standard*(#2) heating speeds try *slow*(#3), which will allow more time during the firing cycle for the heat to equalize in the ware setting, or you can add additional *hold time* (soak) at the final cone temperature. A combination of both may be necessary depending on how heavily the kiln is loaded. Your kiln manufacturer or your controller manufacturer can be a good resource for suggestions to improve your firing program. The first question you will likely be asked is "what do your witness cones show". Repeat the procedure above once the change(s) to the firing cycle have been made.

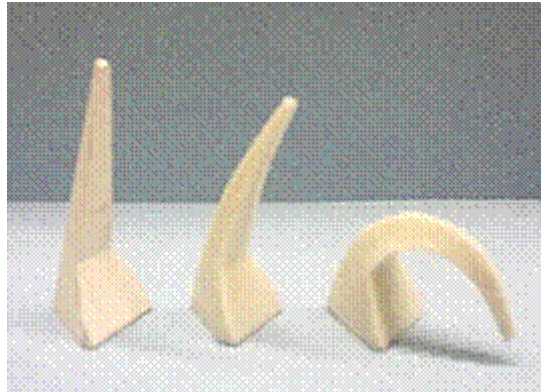

Cone 05 Cone 06 Cone 07

Figure 2. Cone 06 has not reached the proper bending angle, indicating an under-fired condition.

Since minor under-firing may not be obvious to the eye, the use of cones in every firing will alert you if there is a potential problem with the correct amount of heat work being delivered uniformly to your ware. And, when the cones confirm a successful firing, you can sleep a little better knowing you have taken a proactive, safe approach to providing your customers a high quality firing process. Retaining the cones constitutes physical proof that the ware was fired according to the glaze manufacturer's specification.

For more information on the use of pyrometric cones and the firing of ceramics please visit the Edward Orton Jr. Ceramic Foundation on the internet at www.Ortonceramic.com.

The Ceramic Process

What happens when you fire clay.

Loading kiln with greenware

When placing greenware in a kiln, all pieces may touch each other. To prevent possible distortion, place lids on the pieces they go with when firing to bisque. It is important to place the tallest pieces on the center of the shelf and work outward to the shortest pieces. This will give you the best heat circulation. Be sure the ware is totally dry before firing (unless you use a very long drying cycle). Moisture in the work can cause cracking or even an explosion. We suggest using either the SLOW BISQUE program for heavy loads with a Preheat time of between two to three hours or the FAST BISQUE program for lighter loads (again with a Preheat time of two to three hours). If you want to make up your own program, use the preset program as a guide (see Appendix F in the DynaTrol instructions (hotkilns.com/dynatrol-instruct-blue.pdf) for a description of the segments in the preset programs). It is not a bad idea to Preheat the kiln overnight. Its only purpose is to thoroughly dry the ware and to start the expansion of the ware, so that the higher heat will not affect the ware.

Venting

If you are using the **Vent-Sure** automatic vent system, you can turn it on and leave it on during the entire firing. If you use an automatic vent, you do not normally need to prop the lid open or remove peephole plugs. If manually venting (without a powered vent), fire in the beginning with all the peepholes out. Then put bottom peephole plugs into peepholes after the low firing is over (you will know it is over when you start to see red heat through the peepholes). You typically want to leave the top peephole out during the entire firing if you do not have an automatic downdraft vent. NOTE: HEAVY GREENWARE MAY TAKE LONGER TO DRY. Be sure to use the Preheat feature in the DynaTrol for ensuring dry work. NOTE: If you have a lot of moisture in your work you may want to prop open the lid for the first hour of preheat even if you have an automatic vent system. (CAUTION: Propping open a lid in this way can cause the lid to crack if you are not careful, which is not covered in our warranty).

Loading kiln with glaze ware

When placing ware into the kiln to be glaze-fired, we suggest placing the pieces ½” apart,



so that when they expand there is no danger of them touching each other. If pieces are placed too close together, they may touch and stick to each other, thereby ruining both pieces of ware.

Except for placing ware the proper distance from each other for good heat circulation, follow the instructions for the firing of greenware. Be certain that no piece while expanding can touch the thermocouples. Use either the FAST GLAZE or SLOW GLAZE program depending on your glaze needs (experiment if you are not sure), or make up your own program. Ask the supplier of your glaze if you use a commercial glaze. There are some good firing recipes in various glaze books, including Mastering Cone 6 Glazes available from us. Your clay and glaze supplier will know the cone number to which you should fire your work.

Overglaze firing

When firing overglazes such as Gold, Palladium, Mother of Pearl, China Paints, etc., the kiln must be vented during the firing up to 1,100°F. If you are manually venting, leave the peepholes open. (NOTE: This is if you are not using a vent system such as an L&L **Vent-Sure** which automates the venting process). Check with your clay and glaze supplier for recommended cycles.

Speed of firing

Although the kiln may be capable of firing relatively fast, this does not mean you should fire it as fast as it is capable of firing. The speed of firing will depend on what you are trying to accomplish. Check with the glaze or clay manufacturer or supplier for a recommended firing cycle.

Soaking

Soaking is holding the kiln at any given temperature for a set amount of time. One pur-

The Ceramic Process



Robert Shenfeld's studio in Syracuse NY where he produces production quantities of hand-crafted tiles.



505 Sharptown Road • Swedesboro, NJ 08085
Phone: 877.294.0077 • Fax: 877.294.0070
Email: sales@hotkilns.com • Web: www.hotkilns.com



L&L Kiln's patented hard ceramic element holders protect your kiln.

The Ceramic Process

pose is to achieve uniform temperatures on the inside and outside of your pieces. Other benefits include smoothing out of glazed surfaces to get rid of pin holes or craters in the glazed surface. During the bisque firing, people often hold at different temperatures to allow the clay body to out-gas more of its organic material. Holding is also useful at a low temperature like 150°F to 180°F to dry out pottery or kiln wash on shelves.

The downside to holding only happens at high temperatures. There is almost no downside to holding at low temperatures except increased firing time and slight element and thermocouple degradation from the extra firing time. At high temperatures the amount of degradation to the elements and thermocouples is exponentially greater. Therefore, holding the kiln at a high temperature will affect the element and thermocouple life.

Try soak times in the range of 5 or 10 minutes at the most. If longer, exercise care as the kiln may over-fire your work. Compensate by reducing the cone's temperature in the cone offset setting, or raise the thermocouple offset. Use witness cones that you can see through your peephole (and be sure to use dark safety glasses when doing so). If you see the cones bending (which would indicate proper heat-work achieved), then you can always turn off the control at that point manually. The Orton website has a great program available for free which helps you calculate how different temperature ramps and hold times will affect the "heat-work" and cone bending in a kiln.

Firing log

Keep a firing log. Keep track of firing times, approximate load weight, firing temperatures and notes on results of the firing. There is a sample log in our instruction manuals (hotkilns.com/log.pdf).

Applying kiln wash

Kiln wash the floor of the kiln and the upper sides of the shelves only. Apply the kiln wash to the thickness of a postcard. The purpose of kiln wash is to prevent any glaze that drips from ware from sticking to the floor or shelves. If dripping should occur, remove dripping and cover the spot with new kiln wash. Kiln wash is a powder mixed with water to a light creamy consistency. See page 53.

For best results, apply three separate coats. If you brush one coat on, let it dry and then brush on another; you can brush off the first in the process, so ideally each coat should be fired on. The shelf can be used while firing the kiln wash, so theoretically you would

put one coat on, load the shelves and do your test-firing of the kiln. The second coat would be fired on in the first bisque and the third coat in the second bisque or first glaze (whichever comes next). Fire at least to cone 018—hot enough to give the kiln wash enough adherence to the shelf to prevent it from coming off in the second coating. Note that some people make do without three firings of the kiln wash. However, we include this recommendation as a "best practice".

What happens when you bisque and glaze in your kiln

When you fire a kiln, you chemically and physically alter clay and glaze compounds in a way that, to some degree, can be anticipated and accounted for. There is quite a bit more going on during firing than meets the eye. It is useful to divide the processing cycle into separate distinct stages or segments. The stages that clay and glaze go through in a typical firing can be divided as follows:

Complete drying

Even after you room-dry your work there will be some moisture left in the seemingly

dry ware. Your ware will pick up moisture from the air, even if it is left for weeks on a warm, dry shelf. Bisque ware can also absorb moisture during glazing, and the newly applied glaze is really a very fine-grained clay coating at this point; it will retain the water it was mixed with and the water in the air until it is completely dry.

When you put this piece in the kiln it will first go through a complete drying stage. This is where any water that was in your ware evaporates and expands to 1,170 times its original volume. This moisture must escape from your ware before the kiln temperature gets to 212°F. It is important that the kiln temperature climb very slowly at first, and that the lid be propped 1" with several soft pieces of firebrick or ceramic posts and the peepholes opened if there is no forced venting system. (CAUTION: Keep in mind that propping open a lid in this way can cause the lid to crack if you are not careful). If you have a lot of moisture in your work you may want to prop open the lid for the first hour of preheat even if you have an automatic vent system. The amount of drying needed depends on factors such as how much mass is in the kiln and how wet the ware is. Factors that lead to a longer drying time include fine-grained clay and thick-walled ware. Be sure to use the Preheat feature in the DynaTrol, which automatically sets the kiln temperature at the right drying temperature. Preheating overnight is recommended. It is best to be conservative to prevent the ware from exploding in the kiln. After a while you will get a feel for how long is necessary. Remember to carefully vacuum out your kiln if a piece that is not fully dried explodes.

The "Ceramic Change"

This happens to each crystal and mineral particle in the clay body. Even though water between the crystals and minerals has already evaporated (hopefully during the slow preheat time), there is still water in these crystals and minerals that is venting off. This can occur all the way until the kiln reaches red heat. Slow firing is not as critical as there are pathways for the steam to travel through where the water molecules between the particles used to be. Venting, however, is critical to remove the water vapor.

Quartz Inversion

This is a generic name for the 20 or so changes quartz goes through as the temperature increases and the molecules/particles/atoms become increasingly mobile. Most phases that a particle of quartz goes through as the kiln is heating will reverse during cooling. One of the largest and



These instructions refer to the use of our DynaTrol control "Easy-Fire" programs. If you have a manual kiln you will need to adjust the switches to achieve various cycles.

The Ceramic Process

quickest changes the quartz goes through is roughly at 1,060°F with about a 2% increase in the size of the particles during heating. The process is reversed during cooling. Also, during cooling another 2% contraction takes place at about 439°F. This is caused by the formation of “cristobalite” in some clay bodies. There is a lot of other material in your clay besides quartz, so it is not always that important to account for the quartz while the kiln is heating up. The structure of unfired clay is full of pores and non-glass bound particles, so it can withstand the expansion of a few of its quartz particles. Once the clay is fired, though, the particles become part of a solid mass of glass. This mass is extremely intolerant of the expanding quartz particles. This is especially true in the glaze firing (even more so if the bisque was even slightly under-fired). In under-fired ware the quartz never has a chance to react with the fluxes and remains intact during a second firing, ready to expand and contract as your kiln heats and cools. This is one cause of dunting (fine cooling cracks). The glass mass simply has no room for the expanding quartz crystals.

Burnout

This is the burning off of any trapped organic matter in the clay. Burnout generally takes place at and above red heat. Sufficient airflow and time are necessary to burn off all the organic matter. If a bisque piece is under-fired, or fired too quickly, any unburned organic matter will bubble up through the glaze during the second firing. Even if the bisque is properly fired, there will still be some organic matter in the clay that will burn out once you pass the bisque’s firing temperature. A glaze that fluxes too early will block off the exits for the gasses in the clay body and cause bloating or pitting.

Sintering

This is the point at which powdered clay particles will begin to form chemical bonds with each other. Although the clay is not melting yet, it is forming a lump from the powdered clay. The point at which this begins to happen is called the ‘sintering point’. This, like burnout, happens right around red heat.

Decomposition

This is where fluxes really start to react and clay and glaze ingredients are deconstructed into their basic building blocks. This process can emit gasses such as sulfur and carbon dioxide which must travel out of the clay body. Once the firing is finished and the kiln cools, reconstruction takes place and the

glaze and clay body recombine into a glass.

Vitrification

This is a process that develops in the clay body during firing. At one point a piece of clay might be under-fired and at a higher point it may have good strength, but not good color; at another point it may be perfect and at another, even hotter point, the piece may warp, or melt. What is important to understand is that as the firing progresses, more and more activity is taking place on a molecular level. This is good only to a certain point, after which you are left with a warped blob, or puddle. You want to achieve the “glassification” of the clay. This occurs right before the clay body begins to slump. At this point the molecular bond between fluxes, quartz, silica and other materials makes the “glass”. However, it is the formation of the long mullite crystals (which only occurs above 2,000°F) from the decomposing clay crystals that gives the ware its strength.

Glaze set, cool & freeze

Unlike the clay body, the glaze melts completely, and the bond between it and the clay becomes more complete as the temperature rises; eventually, the glaze starts to run. Things like fluidity and surface tension are determined first by the chemistry of the glaze, then by the layer formed by the heightened interaction between the glaze and clay molecules. When the ingredients of the clay and glaze have been properly matched, the nature of the molten layer between the two is such that when the kiln is at maximum temperature during firing, things like pinholes and bubbles can rise through this layer and reach the surface from the clay body within, and not remain trapped in the surface when the glaze sets and begins to cool. Once maximum temperature is reached and the kiln begins to cool, the glaze and clay body will follow. The glaze will not solidify until some time after the kiln begins to cool. When this happens depends on the rate of cooling and the chemistry of the glaze. Right before the glaze solidifies, however, crystals can form. Depending on its chemistry, the glaze can solidify quickly and form crystals. Or, with some glazes, crystal formation can take place throughout the initial cooling until the glaze finally solidifies several hundred degrees lower than the highest temperature. By adjusting the glaze recipe slightly, one can maximize or minimize the forming of crystals in the glaze during cooling. Once the glaze solidifies it is still important for the kiln to cool slowly. Crazing (fine cracking) can occur if cooling is too rapid. Heat shock,



Bill Campbell at work.

“I make a living out of my five L&L kilns. I really beat them up firing them at least three times a week to Cone ten. They take a real beating and keep on going” -Bill Campbell

which is usually catastrophic, is something that can happen in the kiln or may occur gradually over time.

In truth, simply test-firing the kiln and the ware to be fired is usually enough to deal with the complexity of the process. Every kiln and kiln-load fires differently, and a new kiln is no exception. The use of a vent system is recommended simply because it will exhaust any detrimental particles and fumes from the kiln, circulate air in the kiln and provide an oxygen-rich atmosphere. See ortonceramics.com for helpful information on how to use cones, firing tips and great information on firing kilns. They have an excellent program available for free which helps you calculate how different temperature ramps and hold times will affect the “heat-work” and cone bending in a kiln.



Kilns Built to Last

Firing Tips

LOADING A KILN FOR BEST RESULTS

Loading a kiln for firing is not a simple matter of placing shelves and stacking ware. The more thought and planning that is put into loading, the better the results. Ware and shelf placement, the size of the load, the firing characteristics of the kiln and the type of ware being firing are all important factors.

First the Furniture

Kiln shelves come in all shapes and sizes. For economy of space, it is best to choose shelves similar in shape and size to your kiln chamber. For instance, use a round or multi-sided shelf in a round or multi-sided kiln. Keep the size small enough so there is at least 1" of space between the shelf edge and the side of the kiln or the Kiln-Sitter®. Also allow some room between the top of your ware and the lid of the kiln and leave space for witness cones amongst your ware.

Select posts in heights to accommodate the ware you are firing. Leave some room between the kiln shelves for air to flow, for heat transfer and for removal of fumes.

Half shelves are very useful to improve

air movement in the kiln. Use two side by side with a 1/2" space between them and you don't lose much stacking space.

Some kiln manufacturers recommend placing shelves directly on the floor of the kiln. Most suggest using 1" posts to put the bottom up from the cooler floor. This creates an insulating layer much like a storm door.

Setters and Stilts

Air movement in the kiln is clearly a big consideration - one of the most important when loading a kiln. Ceramics need to heat uniformly to prevent warping and stresses in the ware. Air needs to move around shelves and around individual pieces.

Plates and tiles benefit from the use of tile and plate setters or stackers. Shelf-style setters allow air to move under the large flat objects so they heat more evenly. Avoid heating large flat objects directly on the cooler shelf. If you are firing decorated tiles or plates, vertical setters economize on space, and sets can be stacked to fit even more.

Orton

The Edward Orton Jr.
Ceramic Foundation
PO Box 2760 • Westerville OH 43086

FIRING TIPS is a series of firing problem solvers. New TIPS are available every month. Contact your Orton supplier for your copy.

Glazed ware needs to be stilted or dry footed or the melting glaze will stick the ware to the kiln shelf, ruining both. Stilts also provide space for air to move around all sides of the ware. Porcelain and stoneware can not be stilted. The stilts embed into the ware during firing. Instead, use high fire kiln wash or silica sand on the shelf. Use prop to prevent sagging of porcelain.

Consider Heat Distribution

It is important to evaluate heat flow in your kiln and to make this a consideration in loading. Use pyrometric cones to determine the heating characteristics of your kiln so you know where the hot and cooler places are. Arrange your ware with different sized pieces on the same shelf to allow better heat flow.

Don't Overfill

Perhaps one of the most important factors in good fired results is enough air to mature the ware - to burn out organics in bisque and develop best colors in glazes. Shelf and ware placement and the use of setters and stilts can all help this, but here are a couple more tips:

1. When stacking bisque, invert bowls and mugs opening to opening instead of nesting - this helps air move around all sides of a piece and prevents black rings and spots in the bottom of ware.
2. Fire bisque lids and bottoms together. To get the best fit for lids, fire them on the piece they match.

This will let the two pieces shrink together so you get a good tight fit. Fire all glaze pieces separately.

3. Leave space between ware - don't overfill. There is a temptation to cram as much as possible into the kiln to economize on firing costs. Ware fired too closely together creates firing problems. If you must overfill, fire very slowly and vent adequately.
4. Mix thin and thick-walled pieces together throughout the load - don't concentrate them in one area where they are competing for air and heat.
5. Use downdraft venting to move air through the kiln and to remove fumes created during firing.

Want to learn more?

Read more about Loading A Kiln in the Orton Firing Line and Technical Tips publications. Each issue is packed full of articles to help you learn more about firing. Members of the Orton Firing Institute receive these publications at no charge. Single copies are available to non-members at a per issue rate. Orton's 80 minute video, *Key Principles of Successful Firing*, is also an excellent resource on firing.

For information on Orton products, see your Orton dealer or distributor. For information on the Firing Institute or publications, contact

Orton Firing Institute, PO Box 2760,
Westerville OH 43086, 614-895-2663.

**Orton pyrometric cones and bars • KilnVent systems
kiln accessories and firing supplies • Orton Firing Institute**

Firing Tips

UNDERSTANDING HEAT TRANSFER

How Heat is Transferred

Heat moves through the kiln from hotter to cooler zones by:

1. convection
2. conduction
3. radiation

Convection

Convection is the first step in the heating process in the kiln. Air is heated as it passes across the warming kiln elements. As the hot air rises and cool air falls, air currents are created which circulate hot air to cooler places in kiln. This heat is transferred to the ware, shelves, etc.

The kiln will not be uniform in temperature at this early stage of firing unless the hot air is pushed through the kiln by mechanical means. Low cone firings such as 022 and 021 depend more heavily on convection for heat transfer.

The most common type of convection we are familiar with is wind chill. The cool air passes across the face and pulls heat from our warmer body, which lowers our skin temperature.

Conduction

When heat moves through a solid, it is conducted. An example would be heat moving through the handle of a saucepan. This is a slow way to heat, but the handle will eventually get hot.

In a kiln, conduction moves heat from the inside to the outside of the kiln and from the outside to the inside of the ware. Conduction is the main way we get uniform heating in the kiln. This is a slow process and if we fire too fast, the inside of our ware will receive too little heat and not fire properly.

Radiation

At the beginning of the firing, the elements are the hottest part of the kiln. The heat from the elements radiates out - like the sun warming us on a cool day. Eventually the firebrick and the ware will also get hot and will radiate heat as well.

As the temperature increases, more and more of the heat is transferred by radiation from the heating elements. For uniform heating, it is important that all surfaces of the ware be exposed to heating elements, even partially.

**Orton**

The Edward Orton Jr.
Ceramic Foundation
PO Box 2760 • Westerville OH 43086

FIRING TIPS is a series of firing problem solvers. New TIPS are available every month. Contact your Orton supplier for your copy.

4. Time and temperature profile during the burn out period

Both time and temperature are important for proper burn out of the carbon. Some carbons require much higher temperatures than others. Oxidation should be completed below red heat (1400°F).

Carbon burns out from the surface first. As more oxygen penetrates the body, then more carbon is reacted to form the CO or CO₂ gas and the burn out process continues. If there is sufficient time, temperature and oxygen, then complete burn out occurs. If these conditions do not exist, the resulting incomplete burn out is referred to as black coring (where the center of the piece has a black or gray cast).

Incomplete Burn Out

Incomplete burn out can result in several firing problems including:

1. Bloating of the ware
If the temperature is hot enough, the outside of the piece will seal up before all the gases can escape. As the body becomes plastic due to glass forming, gases trapped inside the body expand with heat and cause bloating and sometimes cracking of the ware.
2. Glaze defects, such as pinholes
The escaping gases will push through the glaze surface and cause bubbles which pop. If these do not heal, then pinholes will result.
3. Appearance of fired bisque

Where carbon burn out is incomplete, the piece will have a grayish cast (white bodies) or may have a greenish cast (red bodies). The body will also be more porous and weak.

Preventing Incomplete Burnout

1. Slow down the firing.
2. Be sure the kiln is vented adequately so there is sufficient oxygen.
3. Load the kiln with burn out requirements in mind.

Leave plenty of space between ware and shelves. Do not stack ware. Use tile and plate stackers and invert pieces on top of one another to help conserve space and insure proper burnout.

Want to learn more?

Read more about carbon related glaze and body defects in the Orton Firing Line and Technical Tips publications. Each issue is packed full of articles to help you learn more about firing. Members of the Orton Firing Institute receive these publications at no charge. Single copies are available to non-members at a per issue rate. Orton's 80 minute video, *Key Principles of Successful Firing*, is also an excellent resource on firing.

For information on Orton products, see your Orton dealer or distributor. For information on the Firing Institute or publications, contact

Orton Firing Institute, PO Box 460,
Westerville OH 43086, 614-895-2663.

**Orton pyrometric cones and bars • KilnVent systems
kiln accessories and firing supplies • Orton Firing Institute**

Firing Tips

CRACKING AND THERMAL SHOCK

Cracks that appear in fired ware which were not caused by casting or drying problems may be the result of thermal shock.

Thermal shock occurs when too much stress is created in a piece of ware during the heating and cooling process. It comes from temperature differences in the ware and can cause small to large cracks in the piece, or the piece may actually break.

Why Does Cracking Occur?

The tendency of a piece of be susceptible to thermal shock is related to:

- the strength of the piece
- the thermal expansion of the material

Thermal shock can result when changes in temperature occur in the kiln during heating and cooling. As temperature changes rapidly, the outside of the ware and kiln furniture becomes much hotter or cooler than the inside. This causes stresses which may result in cracking or breaking.

The following can effect thermal shock

- a fast heating rate or rapid cooling
- a sudden influx of cool air such as opening the kiln lid when the kiln has not finished cooling
- in a gas kiln - turning off the gas and allowing cool air from the burners to enter the kiln

Thermal shock can also occur when ware is stressed in use such as a casserole or dish that is taken from the freezer or refrigerator and put into a hot oven.

The stronger ware is, the better able it is to resist cracks due to thermal shocking. Weak ware will be more likely to break when stressed.

A piece that is porous will also be weaker, making it easier to crack. Water or condensation that enters pores in the ware can turn into steam and expand and this can cause cracking when heated. The harder (hotter) ware is fired, the less porous it will be.

Ware that expands and shrinks a great deal during heating and cooling is also more likely to be affected by thermal shock. Most kiln shelves contain

Orton

The Edward Orton Jr.
Ceramic Foundation
PO Box 2760 • Westerville OH 43086

FIRING TIPS is a series of firing problem solvers. New TIPS are available every month. Contact your Orton supplier for your copy.

cordierite because this material has a lower expansion than most of our ware and so less affected by thermal shock.

What Happens to Ware During Firing?

During heating and cooling, the body and glaze undergo many physical and chemical changes. Some of these include:

- moisture is driven out of the ware - if this occurs too rapidly, cracking can occur
- organic material is oxidized and released from the material
- the glaze softens, melts and flows during heating and may trap gas
- the body expands as it is heated and contracts during cooling
- the glaze solidifies and contracts during cooling

If the body or glaze contains silica, it will expand rapidly at 1063°F on heating and contract during cooling. If the heating or cooling is rapid near this temperature, this change can lead to cracking of the piece.

Control of heating and cooling is especially critical when firing thick-walled pieces or pieces with an irregular wall thickness.

Reducing Thermal Shock

There are several easy ways to minimize the potential for thermal shock:

- use a smooth, moderate heating rate
- let the kiln cool naturally with the lid closed

- use a controller to slow down the cooling time
- avoid sudden temperature changes

A programmable controller such as the Orton AutoFire™ is the best solution to control the heating and cooling rates and to get a smooth temperature rise.

If instrumentation is not available, heat loss during cooling can be controlled to some extent by keeping the kiln closed until well below red heat (900°F).

To be sure that ware is properly matured, be sure to use witness cones. Underfired bisque will continue to shrink during the glaze firing and this can result in a poor glaze fit.

Want to learn more?

Read more about cracking and thermal shock in the Orton Firing Line and Technical Tips publications. Each issue is packed full of articles to help you learn more about firing. Members of the Orton Firing Institute receive these publications at no charge. Single copies are available to non-members at a per issue rate. Orton's 80 minute video, *Key Principles of Successful Firing*, is also an excellent resource on firing.

For information on Orton products, see your Orton dealer or distributor. For information on the Firing Institute or publications, contact

Orton Firing Institute, PO Box 2760,
Westerville OH 43086, 614-895-2663.

**Orton pyrometric cones and bars • KilnVent systems
kiln accessories and firing supplies • Orton Firing Institute**

Firing Tips

CRACKING AND WARPING CAUSED BY DRYING AND CASTING

In some instances cracking and warping problems share a common source: the casting and drying of the piece. In other cases, cracking may be related to how the piece is fired. This Tip looks at problems related to casting and drying.

DRYING CERAMICS

Ceramics contain clay which can absorb and hold water. Before firing, it is important to remove all of the physical water so that the piece will not crack or explode when heated. This is often accomplished in steps with firing being the final stage. During firing, the chemical water is removed from the piece and it gains strength while developing physical surface characteristics.

UNDERSTANDING DRYING

Simplified, drying is the removal of water from body by evaporation. As the ware is dried, the film of water separating the clay particles gets thinner and thinner, the solid particles get closer together and the piece shrinks. Shrinkage stops when the particles finally contact each other.

DRYING FAULTS

Cracking, distorting and warping are problems that may not become evident until after firing. They are usually caused by drying too fast or unevenly.

If ware is heated too fast, the pressure from water vapor inside the piece can cause cracking. Ware dried only on one side, can shrink more on that side causing warping or bending of the somewhat plastic (flexible) piece. When one surface finishes drying, the piece is now too stiff to recover and the warping becomes permanent. This can lead to cracking.

Bodies made of very plastic clays or compositions having a high clay content require attention to uniform, slow drying.

Thicker walled pieces will often have a greater tendency to warp or distort.

Care needs to be taken to allow for uniform air movement around all sides of a piece to avoid drying problems. Sometimes drying must be slowed down to avoid cracking.

 **Orton**

The Edward Orton Jr.
Ceramic Foundation
PO Box 2760 • Westerville OH 43086

FIRING TIPS is a series of firing problem solvers. New TIPS are available every month. Contact your Orton supplier for your copy.

Handles on cups can have a tendency to pull away from the mug. Doll heads and chest cavities may deform inward.

REDUCING WARPING AND CRACKING

To reduce warping and cracking, take steps to dry more slowly and more evenly from all sides.

Don't dry a flat object on a wet or cool surface like a formica or plastic table top or damp newspaper. The piece can only dry on one side. Instead, dry objects on something porous like wood or plaster or set them so air can circulate around them. If necessary, turn pieces over during drying for more even result.

Slow the drying of thick walled pieces and hand built ware.

Support areas during drying that might cause stresses to build up.

DRYING TECHNIQUES

slip cast ware - may warp or crack if stressed (deformed) when removed from the mold. Even if the ware is gently returned to the original shape, the created stress will ultimately cause the piece to warp or crack.

wheel thrown ware -should not distort during drying unless subjected to further mechanical forces - let the ware dry naturally on a bat or shelf and it should be fine.

thick handbuilt ware - needs to be

dried for a very long time before it can fired or it may explode during firing. Several days may be required or a low heat drying in an oven may be necessary to remove all the water.

plates - even drying is particularly important with plates. Warping can cause the center of plate to fall or arch up. Rims and centers must dry evenly to prevent warps, humps and cracks.

drying tiles - drying tiles can present a particular challenge because it can be difficult for the piece to dry evenly. Usually air is passed over the top of the tile. This results in warping because the bottom of the tile remains wet. Drying tiles in tile racks can help air movement for more even drying.

Want to learn more?

Read more about Solving Cracking and Warping Problems in the Orton Firing Line and Technical Tips publications. Each issue is packed full of articles to help you learn more about firing. Members of the Orton Firing Institute receive these publications at no charge. Single copies are available to non-members at a per issue rate. Orton's 80 minute video, *Key Principles of Successful Firing*, is also an excellent resource on firing.

For information on Orton products, see your Orton dealer or distributor. For information on the Firing Institute or publications, contact

Orton Firing Institute, PO Box 2760,
Westerville OH 43086, 614-895-2663.

**Orton pyrometric cones and bars • KilnVent systems
kiln accessories and firing supplies • Orton Firing Institute**

Firing Tips

USING THE THREE CONE SYSTEM

All ceramic products fire within a range to develop best fired properties. Some products such as stoneware have a wide firing range. Other products such as porcelain slip and leadless glazes have a narrow firing range (less than 2 cone numbers).

To be sure ware is properly fired, it is important to understand how your kiln is firing. The Three Cone System is an excellent way to do this.

What is the Three Cone System

The Three Cone System consists of three consecutively numbered cones:

Firing Cone - cone number recommended by manufacturer

Guide Cone - one cone number cooler

Guard Cone - one cone number hotter

For example: Cones 017 (guide cone), 018 (firing cone), 016 (guard cone)

Uses for the Three Cone System

- determine temperature uniformity in the kiln
- check the performance of the Kiln-Sitter® or electronic controller
- manually shut off the kiln by direct observation of the cones bending

- evaluate heatwork that ware receives during firing

How Witness Cones Work

Pyrometric cones indicate how much heat has been absorbed. Witness cones set on the shelf near the ware are true indicators of whether the ware received the proper amount of heat. Products are expected to be fired to a cone number or within a range of numbers. For some products, good results can be obtained at a cone lower or higher. Other products have to be fired very precisely.

Using the Three Cone System for Manual Shut-off

By observing the witness cones during firing, the end of the firing can be determined for manual kiln shut off.

To use the Three Cone System for manual shut-off, place cones on a kiln shelf near the center of the load, but out of a draft and where they can be observed through the peephole

When the kiln is near its firing point, the Guide cone will begin to bend. The ware is approaching maturity and soon the kiln can be shut off.

Orton

The Edward Orton Jr.
Ceramic Foundation
PO Box 460 • Westerville OH 43081

FIRING TIPS is a series of firing problem solvers. New TIPS are available every month. Contact your Orton supplier for your copy.

It takes about 15 to 20 minutes for the Firing Cone to reach it's end point. The cone bends slowly at first, and more quickly after the half way point. When the cone tip is even with the top of the cone base, it is time to shut off the kiln. If the Guard Cone bends, the desired heatwork has been exceeded.

Using the Three Cone system to Evaluating Kiln Performance

Most kilns have temperature differences from top to bottom. The amount of difference depends on

- design of the kiln
- age of the heating elements
- load distribution in the kiln
- cone number being used

Usually, there will be a greater temperature difference at lower cone numbers than at higher ones. Placing a set of cones on each shelf during various firings allows you to determine the heating uniformity of your kiln for the materials you fire.

After firing, observe the cones and evaluate the heat distribution in the kiln. If only the guide cone is bent, there is less heat on that shelf. If the guard cone is bent, there is more heat on that shelf.

If you do find a difference, the heating uniformity can be improved by changing the kiln loading, adjusting switching or adding a downdraft vent system.

Checking Kiln-Sitter® Performance

The Kiln-Sitter® is designed to shut off the kiln as a Small Cone or Bar deforms. Here's how it works:

- Small Cone/Bar is placed under sensing rod
- firing begins, cone/bar receives heat, begins to soften
- sensing rod presses down, cone bends with weight
- movement of rod activates shut-off

Because the cone or bar in the Kiln-Sitter® is near the kiln wall (closer to the heating elements), it may receive more heat than witness cones on the shelf. If the kiln shuts off before the witness cones have properly deformed, you may need to use the next hotter cone number in the Sitter®.

Witness Cones Are Like Insurance

Cones are considered an inexpensive way to monitor your kiln and detect problems before a crisis occurs. Use Self-Supporting Cones for the Three Cone System because they are the easiest to use and most consistent cones available.

Want to learn more?

Read more about The Three Cone System in the Orton Firing Line and Technical Tips publications. Published 8 times a year, each issue is packed full of articles to help you learn more about firing. Members of the Orton Firing Institute receive these publications at no charge. Single copies are available to non-members at a per issue rate.

For information on Orton products, see your Orton dealer or distributor. For information on the Firing Institute or publications, contact

Orton Firing Institute, PO Box 460,
Westerville OH 43081, 614-895-2663.

**Orton pyrometric cones and bars • KilnVent systems
kiln accessories and firing supplies • Orton Firing Institute**

Firing Tips

CONES AND CONTROLLERS

Automatic controllers and shut-off devices are a convenient way to heat and turn off a kiln. But for consistent results it is still important to know how much heat the ware received. Only cones provide this information.

Witness cones set near the ware tell if the firing reached the cone value necessary to properly mature the ware. Cones also help in diagnosing firing problems.

Advantages of Controllers

Electronic controllers have many advantages. They:

- allow heating rate control - heat up/cool down of the kiln
- permit slow down of the firing below red heat to burn out carbon and organic materials
- permit elimination of a kiln shut-off device, although some use this as a safety backup
- allow soaking of kiln at the firing temperature to get more uniformity of fired pieces or for special results
- provide more consistency from firing to firing

So with all of these advantages, why

are cones still needed?

Firing Ceramics

Firing ceramics is much like baking food, except ceramics go to higher temperatures. When we bake, we leave food in the oven at a temperature for a certain time. A thermometer may help measure the temperature of our food or we may stick a fork in to test whether it seems right.

It is the same with firing - a combination of temperature and time "cooks" the ware. However, unlike baking we can't put our ware into a preheated kiln and poke a fork in our pot to test doneness. The next best thing is to place Pyrometric Cones near the ware to measure whether it has received enough heat.

Firing With Cones

The bodies, glazes and decoration products we use are all formulated to be correctly fired when they have received enough heat to properly bend a cone. The companies and individuals who make and test these supplies use Orton Cones. Cones deform when they have received the

**Orton**

The Edward Orton Jr.
Ceramic Foundation
PO Box 2760 • Westerville OH 43086

FIRING TIPS is a series of firing problem solvers. New TIPS are available every month. Contact your Orton supplier for your copy.

right amount of heat, not just when the kiln reaches a certain temperature. In other words, cones behave just like your ware. This is why they are such good indicators of whether the ware was properly fired.

How Controllers Work

Electronic controllers regulate power to the heating elements. They do this by comparing the temperature measured by a thermocouple with the expected temperature programmed into the controller. If the temperature is low, heat is added.

Controllers fire a kiln to a temperature. If this temperature is not measured accurately, the controller will fire the kiln improperly. Most controllers use a Type K thermocouple, which is less expensive, or a platinum thermocouple (Type S), which costs more but is more accurate and has a longer life.

Measuring Temperature

Even brand new, a Type K thermocouple can vary from a true reading, as shown below. On the other hand, a Self-Supporting witness Cone will vary no more than 4°F.

Cone	Variation in New Thermocouples		Max. Cone Variation
	Type K	Type S	
020	8.5°F	2.9°F	4°F
06	13.5°F	4.5°F	4°F
6	16.6°F	5.6°F	4°F

This variation in the temperature measured by a thermocouple becomes even larger after the thermocouple has been used for awhile. It is not unusual for a Type K thermocouple to have an error of more than 25°F when fired to Cone 6 repeatedly. This means that more than a full cone error can be introduced.

Using Controllers and Cones

Controllers do a good job at what they do - controlling the heating and cooling rate and providing consistency from firing to firing. However, if witness cones are not used with the controller, there is no way of determining what the actual firing conditions were, except by how the ware looks. By then, it may be too late.

Want to learn more?

Read more about using cones and controlling a kiln in the Orton Firing Line and Technical Tips publications. Each issue is packed full of articles to help you learn more about firing. Members of the Orton Firing Institute receive these publications at no charge. Single copies are available to non-members at a per issue rate. Orton's 80 minute video, *Key Principles of Successful Firing*, is also an excellent resource on firing.

For information on Orton products, see your Orton dealer or distributor. For information on the Firing Institute, video or publications, contact

Orton Firing Institute, PO Box 2760, Westerville OH 43086, 614-895-2663

Orton pyrometric cones and bars • KilnVent systems
kiln accessories and firing supplies • Orton Firing Institute

Firing Tips

AVOIDING CARBON BURNOUT PROBLEMS

Materials used in ceramics contain naturally occurring impurities that can affect the color, appearance and maturing temperature of the product.

Carbon, found in most clays, is normally considered one of these impurities. Carbon can also be present in the additives and binders which make up clay bodies, slips, decals and lusters.

How Carbon Burns Out

During heating (firing) the carbon reacts with oxygen to form carbon dioxide and carbon monoxide gases. The carbon leaves the body as a gas.

Binders are burned off at a relative low temperature: 300°F to 500°F.

Naturally occurring carbon in clay burns off (become gases) at higher temperatures: up to 1200°F-1400°F.

The rate at which this carbon burns out is related to:

1. The amount of carbon present (that is, the amount of natural contaminants in the body)

Some bodies have more contaminants than others, such as red clays. This needs to be considered when planning the firing.

2. Amount of air available (air provides oxygen for burnout)
Air needs to get to the carbon inside the body.

This is impacted by several factors. A load that is fired very quickly will not allow enough time for the oxygen to react with the carbon, form gases and leave the ware.

If ware is stacked during bisque firing, oxygen may not be able to penetrate all surfaces of or inside all the pieces.

Also, if gases are not removed from the kiln and replaced with fresh air, then there may not be sufficient oxygen to burn out the carbon.

3. Thickness of the piece

Air has to penetrate through the entire thickness of the piece and the gases have to escape the same way. It takes longer for carbon to burn out of a thicker piece of ware.

 **Orton**

The Edward Orton Jr.
Ceramic Foundation
PO Box 2760 • Westerville OH 43086

FIRING TIPS is a series of firing problem solvers. New TIPS are available every month. Contact your Orton supplier for your copy.

4. Time and temperature profile during the burn out period

Both time and temperature are important for proper burn out of the carbon. Some carbons require much higher temperatures than others. Oxidation should be completed below red heat (1400° F).

Carbon burns out from the surface first. As more oxygen penetrates the body, then more carbon is reacted to form the CO or CO₂ gas and the burn out process continues. If there is sufficient time, temperature and oxygen, then complete burn out occurs. If these conditions do not exist, the resulting incomplete burn out is referred to as black coring (where the center of the piece has a black or gray cast).

Incomplete Burn Out

Incomplete burn out can result in several firing problems including:

1. Bloating of the ware
If the temperature is hot enough, the outside of the piece will seal up before all the gases can escape. As the body becomes plastic due to glass forming, gases trapped inside the body expand with heat and cause bloating and sometimes cracking of the ware.
2. Glaze defects, such as pinholes
The escaping gases will push through the glaze surface and cause bubbles which pop. If these do not heal, then pinholes will result.
3. Appearance of fired bisque

Where carbon burn out is incomplete, the piece will have a grayish cast (white bodies) or may have a greenish cast (red bodies). The body will also be more porous and weak.

Preventing Incomplete Burnout

1. Slow down the firing.
2. Be sure the kiln is vented adequately so there is sufficient oxygen.
3. Load the kiln with burn out requirements in mind.

Leave plenty of space between ware and shelves. Do not stack ware. Use tile and plate stackers and invert pieces on top of one another to help conserve space and insure proper burnout.

Want to learn more?

Read more about carbon related glaze and body defects in the Orton Firing Line and Technical Tips publications. Each issue is packed full of articles to help you learn more about firing. Members of the Orton Firing Institute receive these publications at no charge. Single copies are available to non-members at a per issue rate. Orton's 80 minute video, *Key Principles of Successful Firing*, is also an excellent resource on firing.

For information on Orton products, see your Orton dealer or distributor. For information on the Firing Institute or publications, contact

Orton Firing Institute, PO Box 460,
Westerville OH 43086, 614-895-2663.

Firing Tips

FIRING HANDBUILT OR THICK CAST WARE

Most pinch pots, coiled or slab built ware generally have thicker walls than their slip cast cousins, although molded pieces may be cast heavily as well. With these types of pieces, the thicker walls create some unique challenges for firing.

Basic problems that can occur when firing handbuilt or thick cast ware include cracking (or exploding) and carbon burnout. Because of the thicker walls it is important to fire slower and control heating and cooling during firing. Preparation of the piece is important as well.

During forming, stresses within the piece may result in hairline cracks that appear during firing. It takes longer to fully dry a thick piece. Uneven drying can result in warping or cracking.

For pieces properly prepared, handled and dried, the next critical step is firing.

Firing issues

- Is the ware fully dry?

Ware that is not adequately dried will crack or explode during the early stages of firing. Water inside the pores of the ware turns to steam, exerting pressure inside the ware. To fully dry a thick walled piece, the ware needs to be warm for more than 12 hours.

- Am I firing too fast?

All bodies expand when heated and shrink when cooled. If the outside wall expands more than the inner wall, stresses occur. If these stresses are large enough, they pull the body apart and cause cracking. A 1" thick wall can have more than a 10°F difference in temperature between the hotter and cooler surfaces. Firings need to be slowed down for thicker wall pieces. Likewise, it is important not to cool too fast.

- Have I allowed enough time for carbon burnout?

It is important to burn out all carbon from the ware before higher temperatures are reached (1200°F or 650°C). It takes time for oxygen to move into the porous body, react with the carbon and then leave. If carbon remains, many problems can occur. These include problems with color, glaze fit, strength, blistering and discoloration. Use of a downdraft vent system, combined with slower heating, virtually eliminates carbon-related problems.

Heating & cooling control

The best way to control cracking problems during firing is by controlling the rate of heating and cooling for the kiln.

Orton

The Edward Orton Jr. Ceramic Foundation
6991 Old 30 Highway
Westerville OH 43082

FIRING TIPS is a series of firing problem solvers. New TIPS are available every month. Contact your Orton supplier for your copy.

During firing, materials that make up the body undergo many changes. Special care must be taken at temperatures below 1500°F (815°C) to heat the body uniformly.

Remember, the thicker the wall, the slower the heating should be done. Above 1500°F, temperatures can be increased more rapidly because the changes are less likely to cause stress cracks within the ware.

- What kind of changes occur?

All clays and many minerals contain water which does not leave the body until above 700°F. Organic (carbon) materials need to be oxidized (burned out). Other minerals, such as calcite, break down and give off a carbon dioxide gas. Minerals such as flint (silica) undergo a sudden expansion on heating to 1060°F and contraction during cooling.

- How can I control my heating?

This depends on the controls for the kiln. With switches, leave them on medium settings longer. It should take more than 3 hours to reach red heat and even longer for thick pieces or a heavily loaded kiln.

Make sure the kiln is well vented below red heat and closed up completely above red heat. Keep the kiln closed during cooling for 8 hours or until well below red heat.

- When did cracking occur?

Often the crack itself can be examined to determine when it occurred. If the edges are sharp, then it probably occurred during cooling. If the edges are rounded or if glaze has flowed into the crack, then it occurred during heating.

- What else can cause cracking?

1. Uneven heating is a primary culprit that causes cracking during firing.

Hot and cold spots in the kiln can cause uneven heating of pieces.

Use witness cones to diagnose hot and cold spots and then adjust the switching or use a downdraft vent to help even out the heating.

Careful loading of the ware in setters and on stilts can also help heat circulate around the piece.

2. Underfired bisque is not as strong and may crack more easily during the glaze firing.

Use witness cone to assure a proper firing and prevent underfired bisque.

3. Gas expanding in air pockets which developed in the ware during forming can cause large cracks during firing.

Want to learn more?

Read more about firing handbuilt and thickcast ware in the Orton Firing Line and Technical Tips publications. Published 8 times a year, each issue is packed full of articles to help you learn more about firing. Members of the Orton Firing Institute receive these publications at no charge. Single copies are available to non-members at a per issue rate.

For information on Orton products, see your Orton dealer or distributor.

For information on the Firing Institute or publications, contact

Orton Firing Institute, 6991 Old 3C Hwy.,
Westerville OH 43082, 614-895-2663

**Orton pyrometric cones and bars • KilnVent systems
kiln accessories and firing supplies • Orton Firing Institute**

Firing Tips

FIRING CERAMIC BODIES

Most bodies and glazes contain clay. These fine clay particles give the body and glaze many desired properties and bonds other materials together.

When the body is fired:

- clay and other minerals in the body start to change
- clay/minerals break down and react with other materials to produce gases
- at 900 F (red heat), tightly held water molecules begin to break free and leave
- gases such as sulfur oxides and some fluorine may be released
- as the temperature increases, clay and other minerals continue to change and react with each other to form new compounds that will be part of the final product
- some products form glass which will bond everything together

Gases

The gases which form need to be removed from the body. For example, carbon is in the clay and organics are added to the body, glaze or decoration to improve strength during handling or application. These must be removed during firing to avoid defects.

Firing Conditions

Firing conditions can also determine many properties of the fired product. Firing too fast at lower temperatures may not allow sufficient time for materials to react and gases to leave the body or glaze.

Firing too fast can result in

- weaker bodies
- pinholing
- bubbling of the glaze
- color changes in the body
- color changes in the decoration
- mildewing of porcelain
- crazing or peeling of glazes if body is not properly mature

TYPES OF BODIES

Earthenware

- typically fired from Cone 07 - 03
- made with talc, less expensive clays
- clays contain many impurities, need fired longer at lower temperatures
- low shrinkage
- porous after firing
- usually tan or red in color
- frequently glazed or stained
- sometimes used as-fired.



The Edward Orton Jr.
Ceramic Foundation
PO Box 460 • Westerville OH 43081

FIRING TIPS is a series of firing problem solvers. New TIPS are available every month. Contact your Orton supplier for your copy.

Often, problems arise because bodies are underfired. The piece may look okay, but is porous and weak. Also, underfired bodies may not match the expansion of the glaze used in a later firing. This can result in glaze fit problems or cracking of the body in use.

The high iron and carbon content of these clays requires plenty of air during firing to maintain good color and to burn out all of the carbon. If this is not done, many problems can occur when the product is glazed and refired.

Stoneware

- typically fired between Cone 6 -10
- large number of compositions
- contain clays and other minerals with many impurities, including sand, feldspar and grog
- additives are used to provide plasticity, workability, strength, color and to reduce shrinkage
- colors depend on raw materials

Because of the additives and impurities, care needs to be given to how stoneware is fired and to proper ventilation of the kiln early in the firing to burn out organics.

Stoneware is vitreous and contains a high percentage of glass in the fired product. For color variations, mature the ware under reducing conditions.

Porcelain

- typically fired from Cone 3 - 10
- compositions vary, but contain high quality materials
- colorants may be added.
- bodies are hard, white, translucent
- very high glass content

- narrow firing range - need to be fired close to slump or sag point for best fired properties.

Because color is very important, these bodies need to be fired with plenty of air below red heat to be sure all the carbon is removed. Shrinkage is high and special care must be given to supporting porcelain during firing or it will warp and distort.

CRITICAL FIRING PERIODS

For all clay containing bodies and for most glazes and decorations:

- be sure ware is dry before firing
- fire slowly below red heat (1100 F) where many changes occur in the clay and other materials
- provide plenty of air below red heat for oxidation and to burn out organics and carbon
- do not to force cool the kiln while it shows red heat.

Want to learn more?

Read more about successfully firing ceramic bodies in the Orton Firing Line and Technical Tips publications. Published 8 times a year, each issue is packed full of articles to help you learn more about firing. Members of the Orton Firing Institute receive these publications at no charge. Single copies are available to non-members at a per issue rate.

For information on Orton products, see your Orton dealer or distributor. For information on the Firing Institute or publications, contact

Orton Firing Institute, PO Box 460,
Westerville OH 43081, 614-895-2663.

**Orton pyrometric cones and bars • KilnVent systems
kiln accessories and firing supplies • Orton Firing Institute**

Firing Tips

FIRING LEAD FREE GLAZES

Changes in glazes

Lead free glazes are becoming the standard for commercial use. This is due to government regulation and health concerns by the manufacturers.

As the name implies, lead free glazes are made from compositions or materials where lead has not been added.

To eliminate lead, glazes are reformulated. This can change some of their properties. Some of the differences you may notice include:

- does not flow or run as much in firing as lead containing glazes
- brush marks may show after firing
- not as wide a firing range
- may not be compatible with as many bodies (improper fit). This leads to shivering or crazing of the glaze.
- color does not match lead glazes
- more surface defects

For problem-free results with lead free glazes, firings must be more closely controlled and kilns well vented. Bodies may have to be bisqued to a higher or lower cone number to solve a problem.

Why do problems occur?

Lead softens a glaze and allows it to be fired over several cone numbers. Glazes made without lead have a narrower firing range. Typically, lead glazes are able to be fired over a four cone number range (example 08 to 05).

Lead free glazes typically need to be fired within two cone numbers (example 06-05) - less than half of that for lead glazes.

Glaze and body fit

Since the glaze and the body on which it is fired (bisque) are made from different materials, it is important that they expand and shrink a like amount when heated and cooled. If they don't, then the fired glaze can be stretched to the point where it can crack (crazing), or it can be pushed together on to itself to a point where shivering or crawling occurs.

When using lead free glazes:

1. Make test firings of the body and glaze to their recommended cone number, first the unglazed body and then the glazed bisque.

**Orton**

The Edward Orton Jr. Ceramic Foundation
6991 Old 30 Highway
Westerville, OH 43082

FIRING TIPS is a series of firing problem solvers. New TIPS are available every month. Contact your Orton supplier for your copy.

2. Use witness cones placed near the ware to be sure the proper cone number was reached. Differences may exist between the Kiln-Sitter® and a witness cone or from the top to the bottom of the kiln. Firing with a controller to a cone number or a temperature may not be adequate.
3. If crazing occurs and the witness cone indicates the glaze and bisque firings are properly fired, make some tests by firing the bisque progressively hotter (e.g. if you fire bisque to 05, test to 04, then 03).

When you fire hotter, the expansion of the bisque is changed and glaze on the bisque may fit better.

4. If shivering occurs, fire one cone cooler. You may need to select another body for your bisque. Firing too cool is not a good idea since the strength is reduced and porosity increased, both of which may cause problems during use of the final piece.

Is Your Kiln Uniform in Temperature?

If temperature in your kiln varies by more than 1 to 2 cones, then glazed ware in one part of your kiln may fire okay, while ware fired in another part of your kiln will have a problem.

Most kilns vary in temperature from top to bottom. To determine how much your kiln varies, place witness cones on each shelf when making firings. Usually, there is less difference top to bottom for hotter firings.

Each kiln has its own personality and the solution for improving temperature uniformity may vary.

If you have glaze firing problems because

of too much variation, then we recommend the following:

1. Make sure cracks and holes are repaired to keep heat in your kiln.
2. Fire slower during the early part of your firing, before red heat (below 1200°F). This allows heat to soak into the refractory and even out temperatures in the kiln.
3. Consider changing the switching pattern to even out top and bottom temperatures. Switch the bottom to a higher setting before the top or vice versa. Higher settings add more heat.
4. Consider adding an Orton KilnVent. These pull hot gases from the top to the bottom of the kiln and cut temperature variations in half. Hoods above the kiln will not help temperature uniformity problems.

Want to learn more?

Read more about glaze and body fit, heat distribution and measuring heatwork in the Orton Firing Line and Technical Tips publications. Published 8 times a year, each issue is packed full of articles to help you learn more about firing. Members of the Orton Firing Institute receive these publications at no charge. Single copies are available to non-members at a per issue rate.

For information on Orton products, see your Orton dealer or distributor.

For information on the Firing Institute or publications, contact

Orton Firing Institute, 6991 Old 3C Hwy., Westerville OH 43082
614-895-2663.

**Orton pyrometric cones and bars • KilnVent systems
kiln accessories and firing supplies • Orton Firing Institute**

Firing Tips

FIRING RED GLAZES

Red glazes are among the liveliest, brightest colors we can use, but unfortunately, red glaze problems are legendary. Many of us simply give up using reds or accept whatever results we can get, including the problems.

Common Red Glaze Problems

improper color development - dark bluish or purple cast to the glaze

color loss - glaze looks gray, white

poor surface texture - a rough matte finish and/or visible surface defects

"The Strawberry Effect" - tiny black dots or spots in the fired glaze

crazing - a crackled or cracked appearance in the fired glaze

Some of these problems relate to the preparation of the piece and application of glaze, but many defects are the result of improper firing practices.

Preparation and Application

1. ware must be clean and free of dust
2. do not apply red glaze to greenware
3. apply only to properly fired bisque (use witness cones to verify firing) -
4. work area and tools should be kept clean and free of contaminants
5. no eating/smoking in glazing area
6. glaze away from cleaning areas
7. apply adequate coats of glaze - four coats is often recommended

8. allow each coat to dry

How Colors Develop

Many ceramic glazes need to be fired in an oxidizing (air) atmosphere for best results. Red, orange and yellow glazes in particular are very oxygen sensitive. This means they require sufficient air during the firing to bring out the colors to their fullest and to prevent surface/finish defects.

Firing reds requires us to control the firing rate and properly vent the kiln.

Controlling the Firing Rate

Nearly all ceramics fire better when fired slowly below red heat. Slow firings have the advantage of allowing the necessary physical and chemical changes to occur in the ware. Slower firings also permit time for sufficient air to enter the kiln and displace the carbon monoxide. This is true for both bisque and glaze firings.

Firing rate can be controlled using the settings on an automatic kiln, programming an electronic controller or by adjusting the switching. Control or slowing of the firing rate is most important in the early stages of the firing when most of the reactions are occurring and when air is needed to

 **Orton**

The Edward Orton Jr.
Ceramic Foundation

PO Box 2760 • Westerville OH 43086

FIRING TIPS is a series of firing problem solvers. New TIPS are available every month. Contact your Orton supplier for your copy

burn out the organics in ceramic materials. Near vitrification (the end of the firing) a faster rate is desirable and can usually be applied.

Venting for Proper Air

It is most important that enough air gets into the kiln in the early stages of firing. This is when the organic materials are burning out of the ware and air reacts with carbon to form carbon monoxide. Kilns can be vented manually or with an automatic venting system.

Manual Venting

Manual venting lets the fumes out of the kiln, but is only somewhat successful at letting air into the kiln. For manual venting, the top lid should be propped and the peephole plugs out for at least the first hour and a half. Slower firings require additional time. When the kiln reaches red heat, the lid can be closed and peephole plugs replaced. Leaving the peephole plugs out for the whole firing is not recommended since it can cause cold spots in the kiln.

Manual venting works better with a smaller load. Also, using split shelves allows air circulation and helps ventilation.

Manual venting is recommended whenever a downdraft vent is not available. When venting manually, it may be desirable to locate red glazes on the top shelf to assure sufficient air.

Automatic Downdraft Venting

A downdraft automatic venting system like the Orton KilnVent efficiently brings the proper amount of air into the

kiln and removes the fumes for exhausting. The kiln lid and peepholes remain closed the entire firing. Using the Orton Vent, tests have shown reds can even be fired with other colors with good results.

Firing to Proper Cone Number

Using witness cones on the kiln shelf to verify results is important to good results. Many problems occur when red glazes are not fired to the proper cone number. Blistering can occur if underfired and loss of color if overfired. Glaze on underfired bisque may craze. Firing lead free glazes to the proper cone number is especially important.

Firing reds can be a challenge, but by following good preparation, application, firing and venting practices, and by firing to the proper cone number, most problems can be eliminated.

Want to learn more?

Read more about Firing Reds in the Orton Firing Line and Technical Tips publications. Each issue is packed full of articles to help you learn more about firing. Members of the Orton Firing Institute receive these publications at no charge. Single copies are available to non-members at a per issue rate. Orton's 80 minute video, *Key Principles of Successful Firing*, is also an excellent resource on firing.

For information on Orton products, see your Orton dealer or distributor. For information on the Firing Institute or publications, contact

Orton Firing Institute, PO Box 2760,
Westerville OH 43086, 614-895-2663.

**Orton pyrometric cones and bars • KilnVent systems
kiln accessories and firing supplies • Orton Firing Institute**

Firing Tips

UNDERSTANDING CRAZING

What is Crazing

Crazing is one of the most common problems related to glaze defects. It appears in the glazed surface of fired ware as a network of fine hairline cracks. The initial cracks are thicker and spiral upward. These are filled in horizontally with finer cracks.

Crazing is caused by the glaze being under too much tension. This tension occurs when the glaze contracts more than the body during cooling. Because glazes are a very thin coating, most will pull apart or craze under very little tension.

Crazing can make foodsafe glazes unsafe and ruin the look of a piece.

There are two types of crazing, each with a different cause:

immediate crazing

- appears when piece removed from kiln or shortly thereafter
- caused by glaze body fit (glaze fits too tightly to body)

delayed crazing

- shows up weeks/months later
- caused by moisture getting into ware

Immediate Crazing

Size Changes During Firing

All ceramic bodies change in size during heating (firing) and cooling. What is desired is for the glaze to shrink a little more than the body during cooling. If it doesn't then glaze problems may occur.

It is important for ware and glaze expansion and shrinkage to match or crazing can occur.

Glazes During Firing

1. during firing, glaze undergoes physical and chemical changes
2. as heating progresses, glaze melts
3. with further heating more liquid forms until viscous or thick fluid
4. more heating, more fluid glaze
5. at this point, viscous (thick flowing) glaze still conforms to size of the bisque.
6. any gas evolving from body will form blisters which can heal if glaze is still fluid
7. when kiln shuts off, glaze and body cool together
8. during cooling, both the body and glaze shrink
9. eventually glaze becomes a hard glass that will no longer flow

Orton

®

The Edward Orton Jr.
Ceramic Foundation

PO Box 460 • Westerville OH 43081

FIRING TIPS is a series of firing problem solvers. New TIPS are available every month. Contact your Orton supplier for your copy.

Thermal expansion/shrinkage properties of both the body and the glaze determine if the glaze crazes.

Glazes are designed to shrink less than the body which puts them in compression, makes them stronger, and makes them less susceptible to crazing.

Solution to Glaze and Body Fit

1. test samples for a good fit
2. bisque to 1-2 cone numbers hotter than glaze to insure body is mature
3. use Self-Supporting Witness Cones to verify heatwork
4. recognize that bodies and glazes will have different fits for different heatwork. A glaze might fit bisque fired to 03, but craze on 07 bisque

DELAYED CRAZING

This type of crazing shows up weeks or months later and is practically always caused by underfiring.

If ware is underfired (does not reach maturity), it can, in time, expand when moisture fills the pores causing the body to expand. Sudden changes in temperature can cause crazing if the body and glaze do not expand or contract uniformly.

Either the body expanding or the glaze shrinking can cause fine hairline cracking (crazing) to occur. Refiring to the proper cone will sometimes solve the problem.

Proper Firing

Firing to the proper cone number is critical to help eliminate crazing problems. Witness cones must be used

to verify the heatwork the ware receives.

If the Kiln-Sitter® turns the kiln off and a witness cone is not properly deformed, then the ware is not fired to maturity.

Underfiring can occur because of:

- variations in kiln heating uniformity
- Kiln-Sitter® out of adjustment and shutting kiln off early
- controller thermocouple inaccurate
- differences in heatwork between kiln shelf and Kiln-Sitter® location

Crazing can also be reduced by slower cooling and slower firing.

LEAD FREE GLAZES

Lead-free glaze formulations today have less of firing range. They develop their fired properties more quickly and this makes proper firing more critical.

Want to learn more?

Read more about crazing in the Orton Firing Line and Technical Tips publications. Published 8 times a year, each issue is packed full of articles to help you learn more about firing. Members of the Orton Firing Institute receive these publications at no charge. Single copies are available to non-members at a per issue rate.

For information on Orton products, see your Orton dealer or distributor.

For information on the Firing Institute or publications, contact

Orton Firing Institute, PO Box 460,
Westerville OH 43081, 614-895-2663

**Orton pyrometric cones and bars • KilnVent systems
kiln accessories and firing supplies • Orton Firing Institute**

Firing Tips

SOLVING GLAZE DEFECTS BLISTERS, CRATERS and PINHOLES

Blisters, craters and pinholes are related glaze surface defects. They show up as a rough, grainy or bubbled surface on the ware and appear after the glaze firing or decorating firing.

What Causes These Defects?

This family of problems can be caused by many different factors including:

- dust and contamination in the glaze
- air bubbles in the glaze
- air trapped in the slip
- improperly mixed slip
- a dirty kiln

Most commonly, however, the problems are related to gases coming from the body, glaze or kiln atmosphere.

What Happens During Firing?

Clays and glazes contain organic materials. When heated, these burn out of the body, forming gases such as carbon, sulfur and water.

If the carbon in materials is not fully removed from the body, then gas will form during the glaze or decorating firing, forming bubbles or blisters. These may pop to become craters or pinholes.

These defects can occur because:

1. There was not enough air in the kiln during firing for the carbon to properly burn out.

Any combustion process requires air. Without air, oxidation cannot occur.

2. Carbon monoxide formed by oxidation of carbon has not been adequately removed from kiln.

If the gases produced during firing are not removed from the kiln, they may deposit onto the glaze surface or affect the glaze color.

3. The kiln was heated so quickly that there was not enough time for the carbon to burn out.

Carbon which is only partially burned will continue to oxidize during the glaze or decorating firing causing defects.

4. The ware was underfired. That is, there was not enough heatwork.

When the body is underfired, it is weaker and its expansion may no longer fit the glaze.

Orton

^(R)
The Edward Orton Jr. Ceramic Foundation
6991 Old 3C Highway
Westerville OH 43082

FIRING TIPS is a series of firing problem solvers. New TIPS are available every month. Contact your Orton supplier for your copy.

How Do I Solve Glaze Defects?

To make sure that glaze defects do not occur, it is important to properly mix glazes and slips and to use good pouring (slip) and application (glaze) techniques. Proper housekeeping for the kiln and workplace should be observed. Straining glaze through nylon often helps remove any lumps.

Most critical for good results are proper firing practices. We recommend the following:

1. Bring air into the kiln and make sure it circulates around the ware especially during bisque firings:
 - use setters and stilts to improve air flow around the ware
 - use half shelves to improve air flow through the kiln
 - adequately vent the kiln
 - position ware to take best advantage of air flow in the kiln

Use a downdraft vent like the Orton KilnVent to bring a controlled amount of air into the kiln and circulate it throughout the kiln. This helps remove fumes and even out the temperatures in the kiln.

2. Control the firing.

Fire slower, especially below 1200°F (650°C). Slow down the firing by adjusting switches to lower settings or soak/hold at a temperature to allow carbon to burn out.

Use an automatic controller to set heating rates and hold times.

3. Use witness cones to verify heat-work.

Underfiring can occur due to burned out heating elements, an improperly adjusted Kiln-Sitter®, a controller thermocouple which has changed or differences in heating within the kiln. Witness cones give a true reading of the heatwork the ware received.

Witness cones placed throughout the kiln show differences in heat distribution.

4. Vent the kiln to remove gases and prevent them from redepositing on ware. Only downdraft venting removes the gases from the kiln.

If good firing and venting practices are observed during firing, problems with glaze surface defects can be controlled.

Want to learn more?

Read more about glaze surface defects in the Orton Firing Line and Technical Tips publications. Published 8 times a year, each issue is packed full of articles to help you learn more about firing. Members of the Orton Firing Institute receive these publications at no charge. Single copies are available to non-members at a per issue rate.

For information on Orton products, see your Orton dealer or distributor.

For information on the Firing Institute or publications, contact

Orton Firing Institute, 6991 Old 3C Hwy., Westerville OH 43082, 614-895-2663.

Orton pyrometric cones and bars • KilnVent systems
kiln accessories and firing supplies • Orton Firing Institute

Firing Tips

SUCCESSFUL GLASS FUSING

Probably the most common problem encountered when fusing glass is that it breaks during firing. There are several causes, including:

1. glass incompatibility
2. glass sticking to shelves
3. glass heated too rapidly
4. glass annealed too quickly

Glass Compatibility

To be compatible, glasses must expand and contract at the same rate when heated and cooled. When this does not occur, they are considered incompatible.

If incompatible glass is fused together and then cooled, stresses will occur in the piece. If the stress is excessive, the fused glass will break either immediately upon cooling or months or even years later.

Glasses are rated using a coefficient of thermal expansion scale. This is based on the linear size change or expansion during heating.

What this means is that the amount the glass expands during heating is

measured and compared to a scale. The larger the number, the greater the expansion. Glass with low expansions will have greater resistance to thermal shock and breaking or cracking.

When you purchase glass, be sure all of the materials you are planning to use in a piece have similar expansion (coefficient) numbers.

Glass Sticking

If kiln wash (shelf primer) is applied unevenly or bare patches are left, the glass may stick as it moves (expands) during the firing process. When this happens, the glass can pull itself apart and break.

Kiln wash should be cleaned off and reapplied in a thin even coating to prevent sticking problems. Take care not to use too much shelf primer as it may require sandblasting to remove it from the bottom of the fired piece.

Glass Heating Too Rapidly

Thermal shocking of glass during

**Orton**

The Edward Orton Jr.
Ceramic Foundation
PO Box 2760 • Westerville OH 43086

FIRING TIPS is a series of firing problem solvers. New TIPS are available every month. Contact your Orton supplier for your copy.

heat up can lead to uneven heating and cracking of the piece. Thermal shocking means that the surface of the glass changes temperature rapidly.

When fusing glass, it is important to control the heating rate between about 150°F and 500°F. For larger or thicker pieces more time is needed. Glass fired in a mold is more susceptible to uneven heating since contacts with the cooler refractory (mold) can lead to uneven heating.

Direct radiant heat from heating elements needs to fall uniformly on the glass or it can cause uneven heating. Most glass firing is done in electric kilns, often with elements above the glass.

Glass Annealed Too Quickly

Annealing is done to reduce stresses in the glass that can result in cracks or breaks. Typically annealing is accomplished by soaking during the cooling cycle (at about 900°F) and then slow cooling between 900°F and 500°F. The amount of time the glass is annealed depends on its thickness. Annealing permits all the glass to equalize in temperature.

When glass is annealed too quickly, stresses can remain that can cause cracking.

When thick sheets or pieces of glass are being annealed, a process called firing down may be necessary. Firing down is done during the slow cooling phase of annealing. Firing down is

used if the kiln is unable to maintain the slow cooling rate required for the piece. The process of firing down involves adding a small amount of heat to the kiln as it cools.

The best way to control cooling during annealing is to use an automatic controller. The desired anneal temperature, soak time and cooling rate are set and the kiln operates automatically. Temperature is displayed. However, even with a controller, the cooling rate set by the operator may be too fast for the kiln to achieve. It is necessary to monitor the temperature change to insure the proper annealing and cooling down occurs.

The thickness of the glass being fired

Want to learn more?

Read more about annealing and firing glass in the Orton Firing Line and Technical Tips publications. Each issue is packed full of articles to help you learn more about firing. Members of the Orton Firing Institute receive these publications at no charge. Single copies are available to non-members at a per issue rate. Orton's 80 minute video, *Key Principles of Successful Firing*, is also an excellent resource on firing.

For information on Orton products, see your Orton dealer or distributor. For information on the Firing Institute, video or publications, contact

Orton Firing Institute, PO Box 2760,
Westerville OH 43086, 614-895-2663

**Orton pyrometric cones and bars • KilnVent systems
kiln accessories and firing supplies • Orton Firing Institute**

Firing Tips

SUCCESS WITH GOLDS

Gold overglazes are known as liquid precious metals. They are expensive and because of this they are traditionally used only for decoration.

Golds are typically used to add detail or distinction to plates, cups and china blanks.

There are several types of gold available in different forms, including bright golds and burnished golds.

Bright Golds

These are gold overglazes. They are not solid gold; instead they contain some percentage of gold, usually about 5 to 15%.

They come as a liquid solution and are usually applied with a brush to reduce waste. A thin coat is preferred to prevent the decoration from running, or failing to adhere.

If the liquid gold becomes too thick, it can be thinned with gold essence. Both of these products are very expensive and come in small vials or bottles.

Burnished Gold

Burnished golds are also gold overglazes. They differ from bright golds in that they require finishing (burnishing) to develop a lustrous finish and bright sheen.

Burnished golds are more durable and have a higher resistance to scratching than other golds. Their appearance is very rich and dense and slightly more matte. The brightness or matte quality can be controlled by application. A thinner application makes for a brighter gold.

Burnished golds contain 16-32% gold, including gold powder. Burnished golds are available in several forms: liquid, paste, dry powder or concentrated pats. The dry powder is extremely expensive.

There are some burnished golds that do not require polishing. These contain between 12 and 20% gold.

Firing Golds

Golds generally fire in the 022 to 018

**Orton**

04: The Edward Orton Jr.
Ceramic Foundation
PO Box 2760 • Westerville OH 43086

FIRING TIPS is a series of firing problem solvers. New TIPS are available every month. Contact your Orton supplier for your copy.

cone range. This can vary greatly depending on the gold itself and the ware it is being used on. For typical glassware, an 022-021 firing is the most common. For china blanks, the gold can fire as high as 011. Follow the instructions of the manufacturer when firing golds.

Gold will adhere best with a slow firing and a soak. This helps them to develop the proper color and finish. A faster firing increases the risk of surface defects which can be magnified through washing or use.

Golds contain heavy solvents which make kiln ventilation a must for both health and safety reasons and to bring air into the kiln. Usually gold is fired alone to reduce contamination problems.

Typical Gold Faults

Most gold faults are surface defects. These include:

cloudy appearance
caused by inadequate ventilation or too heavy application, firing too fast or overfiring

gold not adhering
caused by underfiring or too heavy application

gold is running
caused if application is too heavy

burnished gold is dull
caused by insufficient burnishing or possible underfiring

dull or scummy appearance
caused by inadequate ventilation or possible overfiring

cracking in finish
caused by firing too fast

pinholes and blemishes
caused by poor quality of gold or contamination of gold

blisters
caused by heavy application

Application and proper firing are the key to great gold results. Gold should be applied in moderation using a very light coating. Be sure to vent the kiln until it glows red hot. Use witness cones to verify the proper heatwork was achieved.

Want to learn more?

Read more about using golds in the Orton Firing Line and Technical Tips publications. Each issue is packed full of articles to help you learn more about firing. Members of the Orton Firing Institute receive these publications at no charge. Single copies are available to non-members at a per issue rate. Orton's 80 minute video, *Key Principles of Successful Firing*, is also an excellent resource on firing.

For information on Orton products, see your Orton dealer or distributor. For information on the Firing Institute or publications, contact

Orton Firing Institute, PO Box 2760,
Westerville OH 43086, 614-895-2663.

**Orton pyrometric cones and bars • KilnVent systems
kiln accessories and firing supplies • Orton Firing Institute**

Firing Tips

SUCCESS WITH DECALS

Decals offer an opportunity to add decoration to ceramic and glass ware without the time and skill required for hand painting. When properly applied and fired, decals can add color, texture, design and personalization to a piece.

To achieve professional results with decals, it's important to understand how to select, apply and fire the decals.

- type of decals
 - different decals are made for glass and ceramics
 - ceramic decals often fire hotter than those for glass
- application
 - decals must have good contact with the surface of the ware
 - all wrinkles and bubbles need to be smoothed away
 - avoid tearing the decal
- firing
 - decals are generally low firing - from cone 022 to 016
 - check the package for the proper firing range
- venting
 - decals contain lots of organics which need to be burned off

- often smelly fumes result during decal firings

Firing Decals

A decal isn't fired that much differently than any other piece of ware, although there are some special considerations.

1. Venting is very important to good results with decals - especially to get true colors.

Problems related to venting include:

- poor color development
- a cloudy or hazy appearance

2. Proper heatwork is also an important factor. Decals that are under or overfired may exhibit the following:

- faded colors (overfired)
- color shift (underfired)
- decals rub off (underfired)
- dull appearing metallics (underfired)

Determining Firing Range

Because the colors on decals can so easily be affected by the amount of heatwork they receive, we recommend test firings to determine the best firing range.

 **Orton**

The Edward Orton II Ceramic Foundation
6991 Old 30 Highway
Westerville OH 43082

FIRING TIPS is a series of firing problem solvers. New TIPS are available every month. Contact your Orton supplier for your copy.

Use a series of witness cones to fire samples of the decals on tiles or blanks. Make several firings and then select the fired appearance which looks the best.

Color development

Cloudy looking decals or decals where the color is not bright need to have additional air to develop properly. Organics need to be burned out and carbon monoxide fumes have to be removed from the kiln.

Manual venting by propping the lid and removal of peephole plugs will improve the firing, but may not help bring enough air to the bottom of the kiln or to distribute it evenly throughout the load.

A downdraft vent system will ensure sufficient air is brought into the kiln and circulated throughout.

Measuring heatwork

Heatwork is another critical factor in the color development of decals.

Fading, shifting and dullness are signs of too much or too little heatwork. This is also true when decals rub off after firing. (White or blank spots or burned off areas are generally related to application, not firing.)

Use witness cones to measure heatwork and to check the heat distribution in the kiln. Firing to a temperature or firing to a Kiln-Sitter® cone may not give the same results as found with a witness cone next to the ware.

Measuring heat distribution

Differences in heat distribution from top to bottom in the kiln are usually far more noticeable for cooler firings like decals. A 2 or 3 cone difference at 022 may only be a 1 cone difference at cone 6. This is because at higher temperatures radiation heats the kiln more effectively.

Slowing the first half of the firing can help heat distribution problems. This also helps by allowing more time for air to enter the kiln and burn out organics and for carbon monoxide to leave the kiln.

Use a controller to set heating rates and soaks for more precise firings.

Want to learn more?

Read more about successfully firing decals in the Orton Firing Line and Technical Tips publications. Published 8 times a year, each issue is packed full of articles to help you learn more about firing. Members of the Orton Firing Institute receive these publications at no charge. Single copies are available to non-members at a per issue rate.

For information on Orton products, see your Orton dealer or distributor.

For information on the Firing Institute or publications, contact

Orton Firing Institute, 6991 old 3C Hwy.,
Westerville OH 43082, 614-895-2663.

**Orton pyrometric cones and bars • KilnVent systems
kiln accessories and firing supplies • Orton Firing Institute**

Firing Tips

MAKING FOODSAFE WARE

When making ware to contain food and beverages, it is very important to be sure it is foodsafe. Some of important considerations for mugs, serving pieces and dinnerware include:

- body composition
- design of the ware
- glaze selection
- decoration
- firing to maturity
- testing for lead safety
- government regulations

What Type of Ware?

The design of some pieces of ware have inherent problems which make them unsuitable to contain food and beverages.

Design-related cracks, rough areas, crevices and nooks and crannies are difficult to clean and might trap bacteria. They can also be difficult to thoroughly glaze. Pitchers with hollow handles can have the same problems.

Ware also needs to be serviceable - that is, it should be strong so it won't fail or break during service.

Making Smart Glaze Choices

While glazes are extremely durable, most are not completely insoluble. If attacked by acids in foods such as orange juice, vinegar and tomatoes, small amounts of the glaze may dissolve and pose a health hazard.

Acid resistant glazes have passed rigorous tests and are labeled as foodsafe. These should be selected for glazing food ware. Lead-free glazes may not be acid-resistant and should not be used unless labeled as foodsafe.

Homemade, altered, crackle, matte or specialty glazes also should be avoided for surfaces of containers that will contact food and beverages.

How to Decorate

When glazing, be sure to completely glaze the ware to ensure the entire body is sealed. Properly bisqued porcelain may be dry footed, but only if the porcelain has been fired to vitrification. Label the ware as foodsafe for future users.

China paints, decals and rim designs

Orton

The Edward Orton Jr.
Ceramic Foundation
PO Box 2760 • Westerville OH 43086

FIRING TIPS is a series of firing problem solvers. New TIPS are available every month. Contact your Orton supplier for your copy.

are a popular way to decorate plates and mugs, but may not be safe for food surfaces. Specific regulations exist for the location of rim decorations which must be followed.

Decals should be used on the outside of a piece where they will not be in contact with food or beverages. Use china paints on decorative items only.

Safe Firing

Proper glaze firing and the bisque firing are very important to insure ware is foodsafe. If the bisque is underfired, it may create problems with glaze and body fit that result in crazing of the glaze, or glaze surface defects such as pinholes. These would not be acceptable for ware used to contain food and beverages.

If the glaze is not properly matured, it will not meet the foodsafe standards under which it was tested and may craze while in service.

Using pyrometric witness cones on the kiln shelf is the only way to insure that a proper firing has occurred. For foodsafe ware, many prefer to fire their bisque to an 03 witness cone just to be sure it is fully mature. Read and follow the manufacturer's instructions for glazes for the best and safest results.

Regulations

There are several very specific regulations for ware which will contain or contact food and beverages. California has the most stringent rules for dinnerware and new standards have been set

by the FDA for rim decorations. These rules are available from state and federal agencies. If you are selling your dinnerware you may be subject to additional regulation.

How to Test for Lead Release

Several easy to use products are available on the market to test for lead release. These are primarily quantitative tests - that is, they tell you yes or no if the surface has lead above a certain level. The most commonly used kit is a thick cotton swab which turns pink if lead levels are exceeded. This test does not harm ware so if it tests too high in lead, the piece can still be used as decoration. These tests are a simple, economical way to feel confident that your ware is safe.

Want to learn more?

Read more about Making Foodsafe Ware in the Orton Firing Line and Technical Tips publications. Each issue is packed full of articles to help you learn more about firing. Members of the Orton Firing Institute receive these publications at no charge. Single copies are available to non-members at a per issue rate. Orton's 80 minute video, *Key Principles of Successful Firing*, is also an excellent resource on firing.

For information on Orton products, see your Orton dealer or distributor. For information on the Firing Institute or publications, contact

Orton Firing Institute, PO Box 2760,
Westerville OH 43086, 614-895-2663.

**Orton pyrometric cones and bars • KilnVent systems
kiln accessories and firing supplies • Orton Firing Institute**

DURA-FIRE INSTRUCTION MANUAL

MAINTENANCE



L&L Kiln's patented
hard ceramic
element holders
protect your kiln.

REGULAR MAINTENANCE OF YOUR L&L KILN

REGULAR KILN MAINTENANCE

To keep your kiln in top operating condition, we recommend the following minimum housekeeping:

AFTER EACH FIRING

1) Turn off the kiln at the circuit breaker or fused disconnect switch.

2) Check element holders and walls for glaze, clay chips or anything that could melt at a high temperature. If melted clay or glaze comes in contact with an element, a rapid failure could result. The molten material traps the heat radiating from the element and subsequently raises the surface temperature of the wire. The temperature will quickly pass the maximum recommended for the wire and burn it up. To clean holders, a good shop vacuum will handle dust and loose crumbs. A very gentle chisel or grinder may help with glaze contamination on element holders, but remember that the elements themselves are quite brittle when they are cool. Replace the contaminated holder if you can not clean it. Remove any glaze that has splattered on the firebrick or shelves. (USE SAFETY GLASSES WHEN DOING THIS BECAUSE GLAZE CAN BE LIKE BROKEN GLASS). **Vacuum afterward.**

Note about vacuuming: it is possible to build up a strong static electricity charge when you are vacuuming. If this somehow manages to discharge into the control it can ruin the electronic circuit. Make sure vacuum is grounded and periodically touch some grounded metal surface away from the kiln to discharge the energy.

3) Make sure the floor of the kiln and the tops of the shelves are coated with kiln wash. Kiln wash will keep running glaze from ruining a kiln shelf or the floor of the kiln. (Do not coat the undersides or the sides of the shelves because you do not want the kiln wash to fall off into the kiln).

4) Keep a kiln log of firings. Tracking the performance of your kiln over time may turn out to be an extremely valuable tool if you ever need to diagnose future problems. **Remember that you can easily get the firing time and final temperature at the end of the firing by hitting the Prog Review button if you have a DynaTrol.**

AFTER 10 FIRINGS

1) Check temperatures of the main power cord at the main receptacle and the main kiln breaker while the kiln is at its hottest. If these are hotter than normal, it could be a sign of a loose or corroded connection, or possibly the wire gauge used in the power hook-up is the wrong size for the amount of current being drawn by the kiln. Immediately diagnose and fix this because it could cause a fire.

2) If you have a plug on your kiln, unplug it from the receptacle and check for oxidation or any burn marks, discoloration or melted spots on the plug. If you see this replace the plug (and the receptacle) before using the kiln again. Make sure the receptacle feels tight when you press the plug into the outlet. A loose receptacle indicates worn springs, which will lead to overheating. NOTE: you can put an oxidation inhibitor on the prongs.

3) Check element resistance. You will need a digital multimeter (see the Troubleshooting Guide). Keep track of this information.

4) Check tightness of case and retighten if necessary. (the case will expand and contract during each firing and may eventually become loose. Brick also shrinks slightly with use - especially if used at the higher temperatures like cone 10).

5) Repair any firebrick problems.

6) If you have a manual kiln (or the Dawson backup on an automatic kiln) be sure it is properly adjusted. See the Dawson instructions. Overfiring could result. The tube assembly should be replaced if gets overly corroded or contaminated with condensed glaze or other materials. Dawson recommends checking the pivot point for corrosion and sluggishness every 6 to 12 months.

REGULAR MAINTENANCE OF YOUR L&L KILN

AFTER 30 FIRINGS OR ANNUALLY

1) Check wires for deterioration or oxidation. Replace any that seem brittle or where the wire insulation has deteriorated or fallen off.

2) Check terminals for oxidation (discoloration). If you are near salt air or if you notice corrosion on the stainless exterior of the kiln for whatever reason then do this far more frequently.

3) Check power connection terminals in the kiln and control box for tightness. Be sure to do this with the power disconnected (unplugged) for the kiln. If these terminal connections get loose, heat can be generated (because the electrical resistance gets greater) and this can cause a fire.

CHECK THERMOCOUPLE CALIBRATION

Thermocouples will drift in reading over time. This could potentially lead to an overfiring before the thermocouple actually fails. Although you can not easily check thermocouple calibration, the general accuracy of the entire kiln system can be checked by firing with witness cones. See the LOG, CONES & CERAMIC FIRING section.

DURA-FIRE INSTRUCTION MANUAL



L&L Kiln's patented
hard ceramic
element holders
protect your kiln.

CONTROL

AUTO-CONE® Owner's Manual



Models AC-10, AC-20, and AC-P

The AUTO-CONE® is designed to stop the firing process once your kiln has achieved the desired amount of heat work. Heat work is defined as the combined effect of both time and temperature related to the firing of ceramic ware. Utilizing a small standard Orton cone or bar, the AUTO-CONE® switch will disengage and break the power supply to the kilns heating elements when the cone reaches its equivalent heat work temperature.

The AUTO-CONE® Model AC-10 and AC-20 is supplied with an electrically powered synchronous timer that the operator sets to the estimated time (hours) needed to complete the desired firing. If a malfunction were to occur with the cone or bar the timer will shut the kiln off when it times out without regard for the cone or bar. The timer is provided as a backup to reduce the likelihood of damage to your kiln from over firing.

The AUTO-CONE® requires very little maintenance but may need an occasional adjustment. With proper care and maintenance your AUTO-CONE® should provide you with many years of trouble free service. Replacement parts such as the tube assembly, cone supports or sensing rod are available to extend the operating life of your AUTO-CONE®. Frequency of replacement depends on the type of firing, type of clay used, proper venting and the moisture content of the pieces being fired.

Table of Contents

1. Parts Identification	Page 3
2. Adjustment Procedure	Page 4
3. Test Firing Instructions	Page 6
4. Normal Firing Operation Instructions	Page 8
- How to use the limit timer.....	Page 9
- Venting the kiln	Page 10
5. Using Witness Cones.....	Page 11
6. Maintenance instructions	Page 12

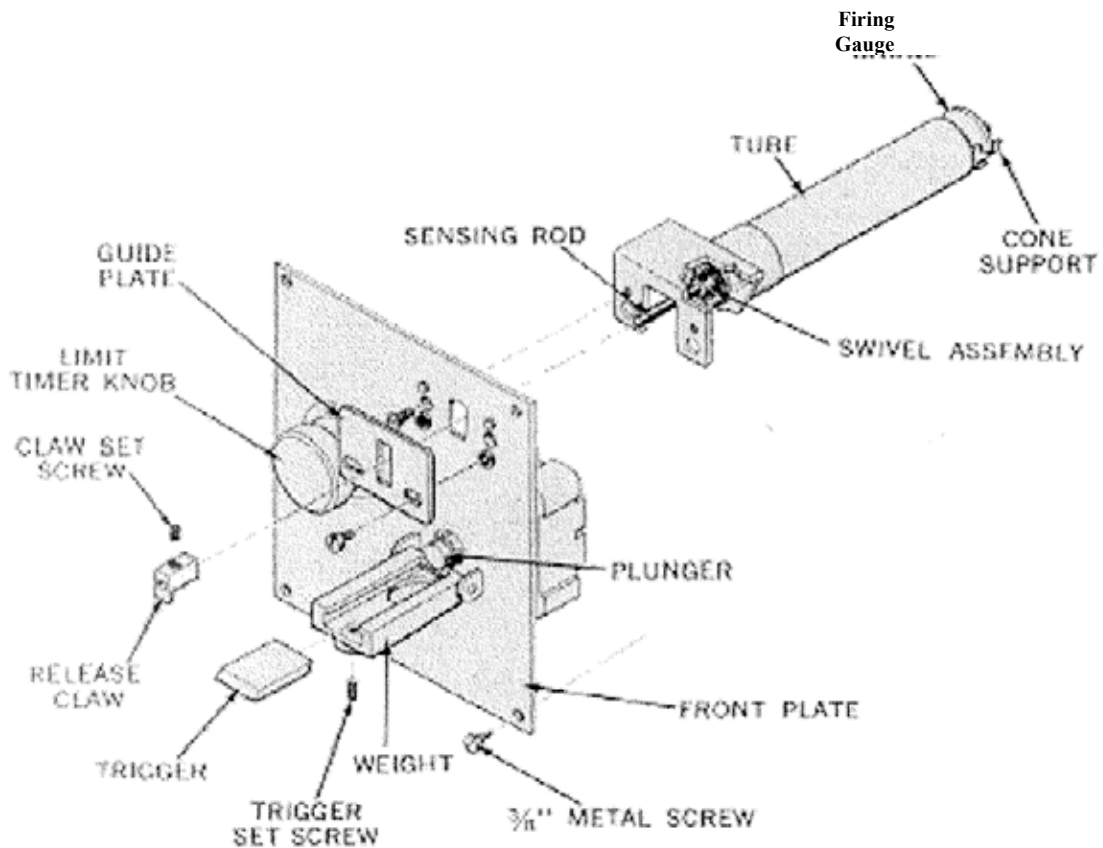

AUTO-CONE® PARTS IDENTIFICATION

Although your AUTO-CONE® was installed by your kiln manufacturer it may require adjustment prior to firing your kiln. Please follow your kiln manufacturer's instructions for the initial firing of your kiln. The instructions for adjusting your AUTO-CONE® found within this manual will guide you through the adjustment process.

To insure that your AUTO-CONE® is properly adjusted, follow the instructions on the following pages and conduct a test firing of your kiln with the AUTO-CONE® before you do anything else. For the test firing, load the kiln with kiln shelves and posts only. Do not attempt to fire any clayware at this time.

ADJUSTMENT/REPLACEMENT PROCEEDURE

Conduct this procedure whenever a new device is used for the first time or after replacing a tube assembly.

**1. Turn all switches to “off” and disconnect kiln from the power supply.
(Unplug the kiln from the power outlet)**

2. Install the firing gauge.

Normally the firing gauge is in position when your kiln is shipped from the factory (held by a rubber band at the end of the AUTO-CONE® tube.) If it has been removed, it should now be replaced over the sensing rod and cone supports, as shown in Figure 1.

CAUTION: Remove firing gauge before operating kiln.



Figure 1.

3. Check the position of holding claw and trigger weight.

First, check your kiln with a level to make sure it is not set on an uneven floor, if it is not level, the weight may not fall when released.

WARNING: Do not fire your kiln over or near FLAMMABLE material (i.e. wood floor, carpeting, etc.)

With the firing gauge in position, swing the weight up against the guide plate. Push the claw down (against the slight play in the swivel/pivot assembly) and check for a 1/16th inch spacing between the inside tip of the claw and the face of the trigger as shown in Figure 2. The set screw on top of the claw may be loosened if the adjustment of the claw position is necessary. The claw should be flush with the end of the sensing rod. Retighten the set screw firmly. The height of the trigger can be adjusted by loosening the set screw as seen in figure 3. The setscrew must be firmly tightened or the force of repeated falling of the weight may cause the trigger to creep out of adjustment.

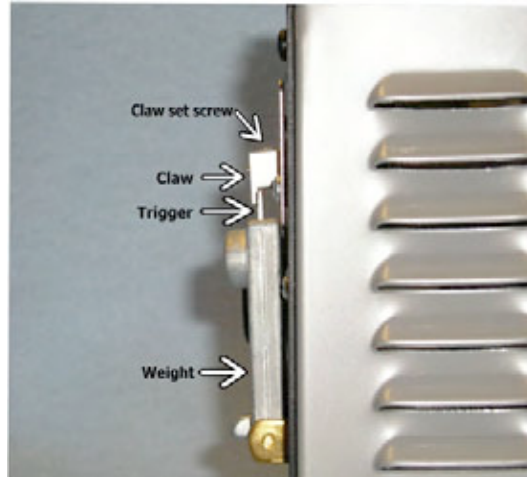

Figure 2.



Figure 3.

When the weight swings forward, the trigger should just clear the underside tip of the claw.

4. Verify free travel of sensing rod.

THE FIRING GAUGE SHOULD NOW BE REMOVED BUT KEPT FOR FUTURE PERIODIC ADJUSTMENTS. The sensing rod is now free to travel vertically within the tube cavity. It should travel freely in the center of the cavity without touching the sides at any point. If necessary, the sensing rod may be centered by loosening the guide plate screws in front of the AUTO-CONE® and moving the guide plate right or left as required. After making your adjustments, be sure the guide plate screws are firmly tightened. When these adjustments have been made, you are ready to test fire.

TEST FIRING

Firing tests are made with the kiln **empty**. To expedite the process it is recommended that you use small Orton cones, which mature at a relatively low temperature, typically a cone 019. This allows you to complete the test firing in the shortest possible time. Additional cones are available from your dealer or direct from Orton on our website store www.ortonceramic.com.

1. MAKE SURE THAT THE FIRING GAUGE HAS BEEN REMOVED.

2. APPLY KILN WASH, to the underside of the sensing rod and the tips of the cone supports and allow it to dry.

(A small nail polish bottle with brush is ideal for this purpose.) Mix Hi-Fire kiln wash with water to a creamy consistency. Apply a THIN coat to the cone supports and the sensing rod where they will come in contact with the cone. Do not apply kiln wash to the cone or to the end of the porcelain tube. Allow wash to dry thoroughly. Do not allow kiln wash to build up and accumulate. It will dry to a white color.

3. RAISE WEIGHT UP AGAINST GUIDE PLATE.

4. PRESS CLAW DOWN LIGHTLY UNTIL IT ENGAGES TRIGGER.

5. INSERT CONE

While holding the claw down over the trigger, carefully place one of the test cones flat on the cone supports with the number facing down. See Figure 8. The cone should be back against the metal step of the cone support with the center of the cone parallel with the end of the tube.

CAUTION: Since the softening and bending of the cone shuts off your kiln, consistency is important for proper firing.

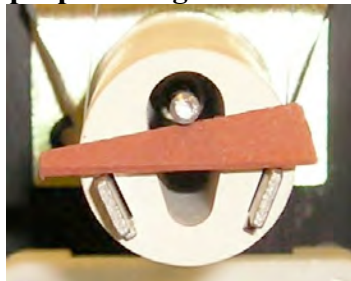

Figure 8

IF THE CONE IS DISLODGED BY ACCIDENT OR ALLOWED TO COME IN CONTACT WITH THE PORCELAIN TUBE, AN OVER-FIRING MAY RESULT WHICH COULD CAUSE SERIOUS DAMAGE TO YOUR KILN

The cone should now hold the claw engaged so that the weight is supported and your hands are free. You are now ready to close the kiln and begin the test fire.

6. TURN ALL SWITCHES to the OFF position.

7. TURN THE LIMIT TIMER KNOB CLOCKWISE TO 2 HOURS ON THE SCALE.

8. INSERT A FINGER INTO THE HOLE IN THE TRIGGER WEIGHT AND PUSH THE PLUNGER UNTIL IT LOCKS. (Refer to figure 3)

9. FIRE THE KILN, SETTING THE KILN SWITCHES AS INSTRUCTED BY THE KILN MANUFACTURER. (For purposes of test firing, when the kiln is empty, the highest kiln switch setting may be used.)

In approximately 1 ½ TO 2 hours the AUTO-CONE® weight will drop, shutting off the kiln. When the kiln is cool you may open it and inspect the cone. If all adjustments have been made correctly, the cone will be bent to an approximate 90-degree angle with a shape similar to the illustration in Figure 9. However, if it is bent similar to the “over-fired” illustration, reduce the kiln switch settings. This will increase the firing time, reduce the rate of climb and allow the cone to mature properly.

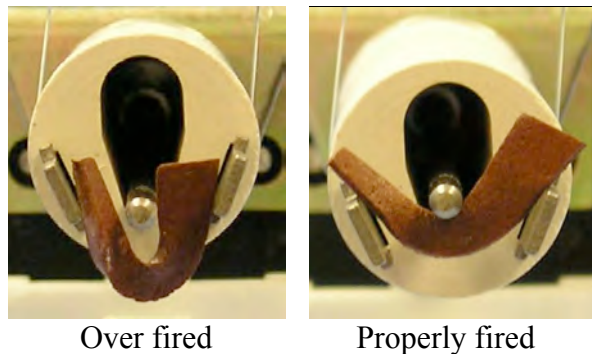

Figure 9.

The best way to verify that your load has achieved proper Heat work is by using witness cones. These are valuable and inexpensive instruments that reliably measure actual firing performance. Witness cones are made in two sizes, Large or Self-supporting. Your kiln manufacturer recommends using witness cones during test firings and also during normal firing operations, as a check for consistent firing performance, for information on witness cones, refer to page 8, Witness Cones, or the Orton Ceramic Foundation website, www.ortonceramic.com.

You are now ready to begin normal firing operations.

NORMAL FIRING OPERATION

It is the responsibility of the AUTO-CONE® user to become familiar with the proper operation and adjustment of the AUTO-CONE®. If the simple steps and precautions, outlined in this manual, are followed with care, it will serve you as a valuable and reliable instrument for greater success and enjoyment in your ceramic firing. When you have assured that the AUTO-CONE® is in proper adjustment, by test firing, as described in that section, you are ready for normal firing operation.

1. CHECK THE SENSING ROD

Before each firing check the sensing rod for free and centered travel. In spite of precautions, the swivel/pivot of the tube assembly can become corroded or contaminated and alter the normal shut off. If the sensing rod moves sluggishly, does not fall freely or you have inconsistent firings, immediately replace the tube assembly.

2. TURN ALL KILN SWITCHES OFF

The life of the AUTO-CONE® switch will be increased if kiln switches are off before engaging the AUTO-CONE®

3. APPLY KILN WASH

Apply a THIN coat of Hi-Fire kiln wash to the cone supports and sensing rod where they will come in contact with the cone. Allow the kiln wash to dry thoroughly. We suggest two pair of supports be available. This allows you to prepare a clean pair while the other pair is being used in the firing.

4. STACK WARE IN THE KILN

When loading your kiln, care should be taken to keep the AUTO-CONE® tube, cone supports, and cone or bar visible from above at all times. If the tube is covered from view, the cone or bar could accidentally be dislodged from its proper position without being noticed and cause a malfunction of the AUTO-CONE® shutoff. Shelves and ware should be positioned at least an inch above or below the AUTO-CONE® tube so that the normal shut-off function will not be obstructed. Be sure to place witness cones on each shelf. Orton has a helpful video “Loading your Kiln” available for purchase on our website, <http://www.ortonceramic.com/store/home.php?cat=249>

5. RAISE THE WEIGHT UP AGAINST THE GUIDE PLATE

6. PRESS THE CLAW DOWN LIGHTLY UNTIL IT ENGAGES THE TRIGGER

7. INSERT THE CONE (Small size cones or bars are used on AUTO-CONE®)

While holding the claw down over the trigger, carefully place the cone or bar, selected for your firing, flat on the metal cone supports with the inside edge of the number circle even with the outside edge of the cone supports. See Figure 8. The cone or bar should be against the metal step with the center of the cone or bar parallel with the end of the tube. Consistent placement of the cone or bar in this manner will lead to consistent firing control. The cone or bar now holds the claw engaged so that the weight is supported and your hands are free.

8. CHECK THE POSITION OF THE CONE OR BAR

As a last step before closing the kiln, always check to see that the cone or bar is in its proper position and free of obstructions. AN IMPROPERLY PLACED CONE OR BAR COULD CAUSE AN OVERFIRING AND DAMAGE YOUR KILN AND WARE.

9. CLOSE THE KILN All switches are off at this point.

10. SET THE LIMIT TIMER KNOB

The timing knob will not allow the plunger assembly to engage when in the OFF position. Always set the timer prior to switch engagement (pushing in the plunger.)

How to use the Limit Timer

The limit timer is a safety shut-off device to protect your kiln from over-firing in case the AUTO-CONE© fails, through some malfunction, to shut off the kiln when the pyrometric cone or bar has matured. The numbers on the limit timer control knob indicate 20-hours of firing time. If your firing requires a longer period, the knob may be reset during firing for this additional time. Since the function of the limit timer is to override the actual firing time, it should always be set for a longer period than the estimated firing time. After you have become familiar with the firing of your particular kiln, you can set the limit time as low as 1/4-hour longer than the estimated firing time. Until you have reached that degree of familiarity, it is safer to set the limit timer 1/2-hour longer than the estimated firing time.

The limit timer may also be used as a timing device to aid you while you are learning to estimate firing times. For example, if the timer knob is set at “7” before firing, and the indicator is on “1” when firing is completed, you know that the elapsed time was 6-hours.

Caution: The timing knob should never be set beyond 20-hours. If the timing motor should be inoperative, such action could jam the switch assembly, possibly causing an over-firing.

11. VENTING

Venting of the kiln for the entire firing period will add years of life to your AUTO-CONE© tube assembly. Use of the Orton Vent Master kiln vent will also help increase the element life and reduce metal degradation.

If you do not have a vented kiln, you should leave the lid open 1 inch and remove the top peephole. After the inside of the kiln begins to glow a dull red, close the lid.

12. INSERT A FINGER INTO THE HOLE IN THE TRIGGER WEIGHT AND PUSH FIRMLY IN ON THE PLUNGER UNTIL IT LOCKS.

13. WEIGHT CLEARANCE

The area outside the kiln should be clear of obstructions so the free fall of the weight is not impeded.

14. FIRE THE KILN BY USING THE REGULAR KILN SWITCHES, AS INSTRUCTED BY THE KILN MANUFACTURER. DO NOT LEAVE THE KILN UNATTENDED BEYOND THE ESTIMATED FIRING TIME. An uncontrollable accident, such as greenware falling against the end of the AUTO-CONE© tube, may cause an over-firing, which could damage your kiln. Should this occur, the operator should be in attendance to manually shut off the kiln.

WITNESS CONES

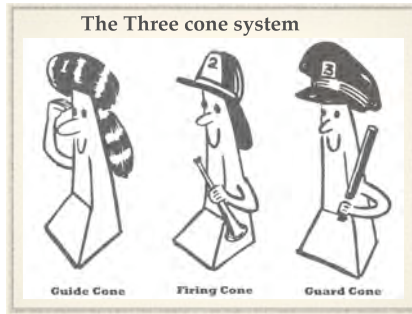

An Orton pyrometric cone is a slender triangular pyramid composed of materials that will react to time and temperature in the same way as the ware you place in your kiln. The cone is a most valuable tool for determining the accuracy of your kiln. Orton manufactures four types of pyrometric cones; Self-supporting, Large, small and bar. The self-supporting cone and large cone are used to monitor heat work. Heat work is the combined effect of time and temperature applied to a heated item. These cones are placed throughout the kiln next to the ware to measure the heat work on each shelf. Small cones or bars are primarily used in the Autocone.

Even though small cones or bars are used in the AUTO-CONE©, the use of large or self-supporting cones is highly recommended when firing your kiln with an AUTO-CONE©. The Large or Self-supporting cones, also called witness cones, help you determine whether the AUTO-CONE© is properly adjusted. Conducting test firings will help you to learn your kiln's "personality" or its heat distribution.

When firing, you will need three different large cones mounted into a plaque (or three self-supporting cones). A plaque is a porous clay base designed to hold three large size cones at an angle of 8-degrees from vertical. The first cone in the group is called the GUIDE CONE. It is one cone number cooler than the firing cone. The guide cone matures at a temperature approximately 30-degrees lower than the firing cone. When it bends, it serves warning that shut-off time is near. The cone number we wish to fire to is placed in the middle. It is called the FIRING CONE. In most cases it is the same cone number as the cone on your AUTO-CONE©. When it bends over with the tip close to, but not quite touching, the base, you know that the desired heat treatment has been reached.



Figure 14

The final cone in the series is one number hotter than the firing cone, It is called the GUARD CONE. If it bends at all, you know that the kiln has fired beyond the pre-selected point. The three cones should be placed on a shelf close to the level of the AUTO-CONE© tube and on any additional shelves used to load the kiln since temperatures vary at different levels within a kiln.

Please note, because a shelf supported by stilts is not completely stable, the height of the shelf should be one inch above or one inch below the tube. This will prevent a possible jamming of the normal AUTO-CONE© shut-off function should the shelf expand or tilt in the direction of the tube.

When setting your kiln shelves, follow the kiln manufacturer's instructions. The spacing between shelves will depend upon the objects you wish to fire. This spacing, as well as the size and weight of your ware, has an affect on heat distribution.

After firing is completed, you will see some differences in the appearance of the cones. If for example your firing was made with two or more shelves, the lower shelf will usually show less bending of the cones than the plaque located on a shelf near the top of the kiln. This range of heat treatment normally will be within the range recommended for your materials. The shelf locations, and amount of material placed on each shelf, and the switching sequence, will have some affect upon the heat distribution in your kiln. But as long as each set of cones show cone values within the range recommended for your material, you can be sure it is receiving proper heat treatment.

Now fire the kiln in the manner recommended by the kiln manufacturer. Use the proper switch sequence and follow venting procedures for necessary air circulation. If witness cones, after the first test fire, appear similar to those illustrated in Figure 14, you will know that the AUTO-CONE© is in proper adjustment. But make a second test firing exactly as you did before. This will serve as a double check and indicate the consistency of firing performance.

If the witness FIRING cone is UNBENT, then test fire a second time using a hotter cone on the AUTO-CONE© (one number higher.) If a second test fire, as recommended above, does not cause proper maturing of the witness cones, as illustrated in Figure 14, then it is recommended that you recheck all adjustments, as described in that section and repeat the two test fires.

MAINTENANCE OF YOUR KILN-SITTER

Your AUTO-CONE© is manufactured from the finest materials available ... selected for strength, durability and resistance to heat and corrosion. However, during the firing operation, moisture and corrosive gasses are created which can, in time, alter the normal shut off function. Below are maintenance procedures and operating recommendations which will keep your AUTO-CONE© doing its job. Careful attention to these instructions will reward you with trouble free firing

NEVER USE LUBRICANTS OF ANY KIND ON THE AUTO-CONE ©

PERIODIC ADJUSTMENTS

The AUTO-CONE© may get out of adjustment during use and we suggest you repeat an adjustment check every 30 firings as described under "Adjustment Procedures".

VENTING THE KILN

Orton recommends using the Vent Master kiln vent for all kiln firings. Venting will reduce deterioration of the kiln's metal parts and increase the life of the tube assembly. In the event that no vent is in use, the top peephole should be left open for the entire firing period. Information on the Vent master can be seen on the Orton Website www.ortonceramic.com

CARE OF CONE SUPPORTS

It is important that excess kiln wash not be allowed to accumulate on the supports. We recommend they be cleaned after every firing with a small wire brush. In the event the kiln wash or cone glaze cannot be removed, rotate the supports to the clean side or replace them. We suggest two pair of supports be available. This allows you to prepare a clean pair while the other pair is being used in the firing.

CARE OF THE SWIVEL/PIVOT (Tube Assembly)

The swivel/pivot of the tube assembly is the most sensitive part of the AUTO-CONE© and can become corroded and contaminated during normal firing. This can cause sluggish movement of the sensing rod and alter the shut off of the AUTO-CONE©. We recommend, as good insurance against a mishap, that the guide plate be removed and the swivel/pivot of the tube assembly be examined every 6 to 12 months. The frequency of inspection depends on the type of firing, clay composition and moisture content, and humidity in the area. Evidence of contamination or sluggish movement would indicate the need for immediate replacement of the tube assembly

SENSING ROD

Continued operation at high-fire temperatures will eventually cause the end of the rod to deteriorate or bend. This will, in turn, affect the adjustment of the trigger and claw. If this occurs, the rod must be replaced.

OPERATIONAL TEMPERATURE

The AUTO-CONE© is engineered to withstand kiln temperature up to and including Cone 8. Temperatures higher than this limit will reduce the normal lifetime of the cone supports and sensing rod.

DURA-FIRE INSTRUCTION MANUAL

VENT

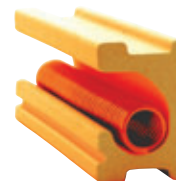

L&L Kiln's patented
hard ceramic
element holders
protect your kiln.

Downdraft Vent for L&L Kilns

FEATURES

Type of Vent: Downdraft - pulls air from the bottom of a kiln to ventilate fumes from the kiln under vacuum. Vents kiln fumes to the outside. The Vent-Sure downdraft ventilation system produces better firing by promoting higher temperature uniformity in the kiln - up to a 1/2 cone improvement.

Voltage and Amperage: 120 Volts at 1.37 Amps.

On/Off Switch and Cord: Switch on six foot cord.

Blower Mounting: Blower is normally mounted on the wall with discharge through a 4" round opening. (See Options below for optional Multi-mount bracket). This keeps the heat of the kiln away from the motor (for long motor life) and keeps the motor vibration away from the kiln (which can cause ware to move, damage to the kiln, and misfiring of cones on a kiln sitter). Although the vent motor normally discharges right through the wall it is mounted on, use of 4" duct can extend this distance 60 feet (horizontally or vertically) with up to four 90 degree bends.

Duct Work: 15 Feet of 3" flexible and expandable duct is included along with necessary hose clamps. Longer lengths or lengths of 3" stove pipe can be used as well.

Capacity: The blower vents up to 148 cfm (cubic feet per minute). This will handle up to a 20 cubic foot kiln (and usually larger) or even two separate kilns. More than one vent can be attached to larger kilns.

Vent Control: A vacuum bypass on the kiln bypass/collection box adjusts the amount of venting from the system.

Application: The Vent-Sure is designed to be used on almost all our kilns, as well as other brand kilns. You can order one of our Easy-Fire kiln stands with the bypass/collection box attached to the bottom or you can attach the bypass collection box directly to the side of the kiln. (See hotkilns.com/vent.pdf).

Warranty: Limited 3 year warranty. (See hotkilns.com/warranty.pdf).

UL Listing: The Vent-Sure is c-MET-us listed to UL499 standards for use with Easy-Fire, Jupiter, JH Series, and DaVinci kilns. It is MET-us listed to UL499 standards for use with Hercules, Easy-Load, and Renaissance kilns.

OPTIONS

Vent Doubler: The Vent-Doubler allows you to connect two kilns to a Vent-Sure vent system. This can be added to an existing vent system or ordered with a new vent. In some cases you may be able to fire two kilns at once. The Vent-Sure has enough force to vent at least 20 cubic feet of kiln. The "T" duct fitting attaches to the inlet of the fan motor. There are two dampers on it to allow you to both control the flow and to shut off one or the other kiln. Flexible aluminum duct connects this "T" duct and the two fittings that attach to the kiln stands. M-V-VENT/DB

Multi-Mounting Bracket: An adapter to mount our motor on the floor is available for people who don't want to mount the motor on the wall. There is a 4" duct outlet that you can hook up to an existing wall opening. This can be used to mount motor on wall as well with output going into an existing ventilation system. M-V-BRKT/00

220-240 Volt Option: Motor is 220 volt. Plug to be specified.

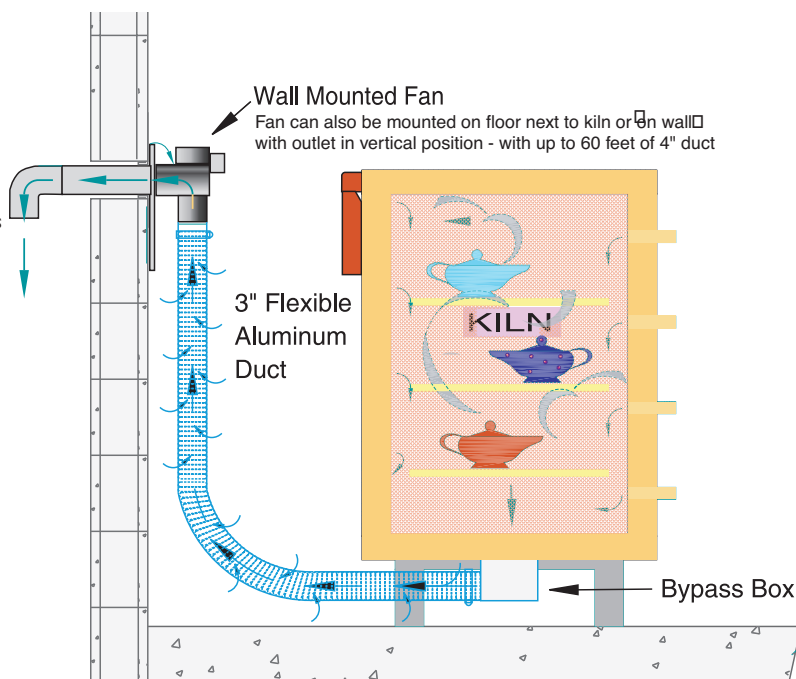

The Vent-Sure pulls air out of the kiln and the room keeping fumes in the duct under vacuum so any leaks get pulled out instead of pushed into your room. The Vent-Sure is the worry-free, super-safe vent!

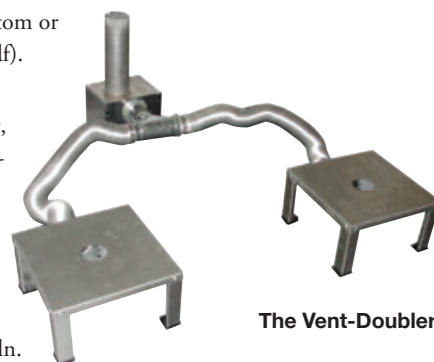

The Vent-Doubler



The Multi-Mounting Bracket

FREQUENTLY ASKED QUESTIONS

How do I know if the system is working?

The easiest way to test the operation of the vent system is to turn the unit on and to place a lit match directly over and level with one of the holes in the bottom of the kiln. The flame from the match should be gently pulled into the kiln as a result of the draft.

How hot does the duct get during the firing?

Due to the introduction of fresh air through the plenum of the vent system mixing with the hot gases being drawn from the kiln, the temperature of the duct is below 150°F. This will prevent burns from occurring in the event of the duct being touched.

How long can the duct be and with many bends?

Up to 60 feet of ducting containing four 90 degree bends may be safely used with no drop in static air flow at the duct exhaust point or a reduction in draw at the kiln. The ducting can be run either horizontally or vertically.

Do I need double wall duct when going through the roof?

You do not normally need double wall ducting when going through the roof since the pipe or duct does not reach high temperature. It is always advisable to check your local building codes for their requirements.

What type of duct do I use if I need more than 15 feet?

You can use more of the flexible aluminum dryer ducting or you can use galvanized furnace ducting. We recommend using 4" diameter galvanized duct.

Will the fumes coming through the vent damage my plants, the neighborhood pets or disturb the local environment?

No. The fumes and the gases coming from the kiln have been diluted with enough fresh air to make them safe for the environment. Do not, however, place the outlet of the vent below an open window.

Will using the vent cause my firing to take longer?

The vent system pulls only a very small amount of air out of the kiln, so very little heat is removed and firing times will change very little. For some kilns, a high firing may take a little longer. The insulation value and the number of air leaks in the kiln also determine the length of the firing. We have seen vents overpower smaller kilns - so it is important to adjust the amount of venting in some cases. On the other hand an example of an e23T seven cubic foot kiln firing an 85 pound load on Fast Glaze program to cone 8 took 7 hours and 4 minutes with a vent on and 6 hours and 24 minutes without a vent. The vent was on the whole time.

What does it cost to operate the vent system?

The vent system typically costs less than 1 cent/hour to operate (electricity costs). Vent systems save on heating and cooling costs when compared to hoods. Hoods remove massive amounts of air from the kiln room - air that may have been heated or cooled, depending on the time of year. Downdraft type vents remove 80% less air in the kiln room than a hood. (It does cost more to run the vent because it does take heat out of the kiln. For instance an e23T in the example above took 70 KW hours with a vent on and 62 KW hours without a vent. At 8 cents per KW hour that would be a cost of \$0.64. The vent was on the whole time).

Will the cold air entering the kiln damage the product?

The amount of air that is entering the kiln is so small that it does not cause problems with the ware. The top holes are placed toward the outside of the chamber area so that no air comes down directly onto ware that is placed near the top of the kiln. (L&L NOTE: This is fine but we do not normally recommend holes in the lid - a kiln is porous enough).

Will faster cooling crack the ware if I leave the vent on during the cooling Cycle?

No. Some kilns can cool an average of 4-1/2 hours faster with the use of the vent system. The cooling is faster but it is taking place at an even rate throughout the kiln avoiding uneven stresses being placed on the ware. Most ceramic ware can be cooled more quickly if the cooling takes place at an even rate. The rate of cooling increase will depend on the kiln size and the density of the load. The vent will remove more molecules of air and hence heat as the kiln cools. This is because the density of the air increases the lower in temperature you go. This is one reason why kiln vents are so efficient - they don't remove too much heat when you don't want them too at the higher temperatures).

What should I do if I still smell fumes?

You should check your duct work to make sure it is properly connected and that the joints are sealed. You can also check for extra air leaks around your kiln and repair these if necessary.

Note: These Frequently Asked Questions are provided courtesy of The Edward Orton Jr. Ceramic Foundation with some modification based on our Vent-Sure vent system and experience.



This shows several small kilns hooked up with one Vent-Sure using two Vent-Doublers. (Up to 20 cubic feet can be ventilated with one vent).

L&L VENT-SURE DOWNDRAFT KILN VENT SYSTEM

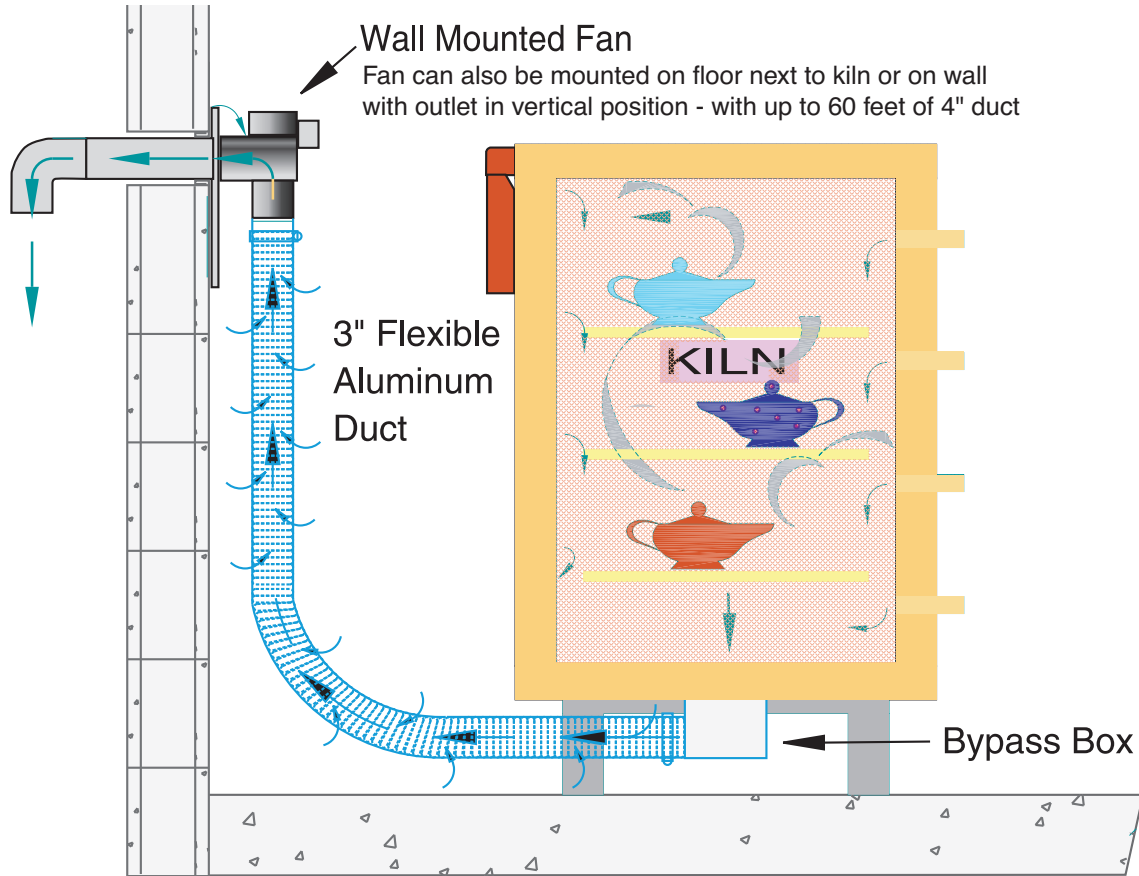

TABLE OF CONTENTS

INTRODUCTION	2
WHAT DOES THE VENT DO?	2
MOUNTING OF THE VENT BLOWER	2
NEGATIVE PRESSURE	2
AIR INLETS	2
HEAT IS AWAY FROM MOTOR	2
IMPORTANT CAUTION	3
WHAT IS INCLUDED	3
FEATURES AND SPECIFICATIONS	4
ADJUSTABLE AMOUNT OF VENTING	4
EXTERNAL VENTING	4
REMOTE MOUNTING OF MOTOR	4
MOUNTS ON ANY KILN	4
POWERFUL VENT MOTOR	4
OUTLET TEMPERATURE UNDER 150oF	4
FLEXIBLE DUCT INCLUDED	4
LOW ELECTRICITY USAGE	4
VENTS UP TO 20 CUBIC FEET OR MORE	4
INSTALLATION	5
IMPORTANT CAUTION	5
Step 1. Turn Off Kiln Power	5
Step 2. Install Bypass/Collection Box	5
Step 3. Install Blower System	5
A CAUTION ABOUT MOUNTING VERTICALLY	5

Step 4. Connect Flexible Duct	6
Step 5. Plug In Vent	6
ROOM AIR REPLACEMENT	6
ROOM AIR REPLACEMENT:	6
INSTALLATION OF MULTIPLE VENTS	6
VENT DOUBLER SYSTEM	6
CENTRAL VENT SYSTEMS	6
CENTRAL DUCT SIZING	6
EXTENDING DUCT LENGTH	6
TYPICAL NUMBER AND SIZE OF HOLES TO BE DRILLED IN L&L KILNS	7
OPERATION	7
IMPORTANT CAUTIONS	7
ADJUSTING THE BYPASS SYSTEM	7
VENTING CODES	8
REGULAR MAINTENANCE	9
FREQUENTLY ASKED QUESTIONS	9
PARTS	11
Complete Vent-Sure Kiln Vent System	11
You can also purchase individual parts to suit your own configuration or as replacements:	11

L&L VENT-SURE DOWNDRAFT KILN VENT SYSTEM

READ THE INSTRUCTIONS

You are now the proud owner of an L&L "VENT-SURE" kiln ventilation system, engineered to give you the utmost in performance and results. This is an expensive and potentially hazardous appliance (if not used with proper caution). PLEASE TAKE THE TIME TO READ THESE INSTRUCTIONS. There is important information that you need to understand to operate your L&L kiln ventilation system safely and properly.

CHECKING SHIPMENT

Your ventilation system was carefully packed and inspected prior to shipment to make sure that all accessories were in perfect condition.

When carrier makes delivery, you should immediately unpack your ventilation system and accessories to determine whether or not any damage has occurred in transit.

If damage has occurred, retain all of the packaging material and notify the delivering carrier at once, requesting an inspection report. Retain all papers to insure that a proper claim can be filed. We will assist you in any way possible with your claim; however, filing and collecting on freight claims is the receiver's responsibility.

INTRODUCTION

WHAT DOES THE VENT DO?

The Vent-Sure Kiln Ventilation System is designed to pull air contaminated with carbon monoxide and other fumes including those of volatile metals, decals, sulfur oxide, and others in a down draft fashion out of the kiln and then vent it outside or to a central vent system.

MOUNTING OF THE VENT BLOWER

The vent blower is mounted on an outside wall or window, or near an existing exhaust ducting system. (With the special "Multi-Mounting Bracket" the vent motor may be mounted on the floor or a wall with the outlet pointing up and then connected to an existing vent system or 4" wall outlet). The Bypass Collection Box mounts to the kiln either on the side of the bottom

kiln section, or underneath the kiln on the kiln stand. (Jupiter and Easy-Fire kilns have studs on the stands to accept this box). It covers holes drilled through the brick. The blower is then connected to the Bypass Collection Box with the flexible aluminum duct, and the blower is plugged into a 120 Volt receptacle for operation.

NEGATIVE PRESSURE

When operating, the Vent-Sure system creates a negative pressure (partial vacuum) in both the Kiln and the flexible aluminum duct, so that fumes are pulled out of the kiln as well as out of the flexible duct. No taping of joints is necessary (although it is OK to do this). Should a leak develop in the duct, air will be sucked into the duct rather than blown out of it. This is a major advantage of the L&L Vent-Sure vent system.

AIR INLETS

Normally no holes are necessary in the lid brick for fresh air inlet as the leaks in most kilns allow sufficient fresh air to be drawn into the kiln through element end penetrations, peephole plugs, leaks between the lid and the top section, leaks between sections, and leaks between the bottom section and the bottom brick. Holes may be drilled in the lid brick at any time if later found necessary. If you decide to drill holes in the lid start with a 1/4" diameter hole drilled about 4 inches in from an edge of the lid (and then add other holes as necessary in the back of the lid and then on the sides). BE SURE NOT TO DRILL ANY HOLES WITHIN 6" OF THE THERMOCOUPLES. You do not want cold air flowing onto the thermocouples.

HEAT IS AWAY FROM MOTOR

Other important advantages of the L&L Vent-Sure downdraft kiln vent system are that the motor, being mounted away from the kiln (and the floor), will not pick up brick dust (which could destroy the motor), will not cause the kiln to vibrate (which can cause ware to move, damage to the kiln, and misfiring of cones on a Dawson Kiln Sitter) and will not be affected by the heat of the kiln. Because the motor is not under the kiln you can turn the vent off whenever you want. It is not necessary to keep it on to cool the motor as in some other kiln vents.

L&L VENT-SURE DOWNDRAFT KILN VENT SYSTEM

IMPORTANT CAUTION

DO NOT OPEN ONE OF YOUR PEEPHOLES WHEN USING A THE VENT-SURE VENT (regardless of what it may say in the Dawson Kiln Sitter manual). Opening a peephole is acceptable ONLY when venting your kiln manually by opening the lid. Also do not open the lid when venting with the Vent-Sure. It will let in far too much air when you are using a motorized vent. THIS CAN BE DANGEROUS because the cold air can cool down the thermocouples or Dawson tube assembly and trick the thermocouple or cone into thinking that the kiln is much cooler than it really is. THIS COULD LEAD TO AN OVERFIRED KILN OR OVERFIRED WORK!

WHAT IS INCLUDED

One (1) wall-mounted blower mounted on a bracket with vent pipe to go through outside wall and a Motor Inlet Duct. An 8 foot power cord with an attached On/Off switch plugs into a 120 volt standard receptacle.

One (1) Bypass Collection Box to be mounted to the kiln or on the kiln stand, with mounting hardware.

One (1) length of flexible aluminum ducting (expands to 15 feet).

Two (2) hose clamps.

One (1) 4" diameter 90 degree elbow (for outside the building).

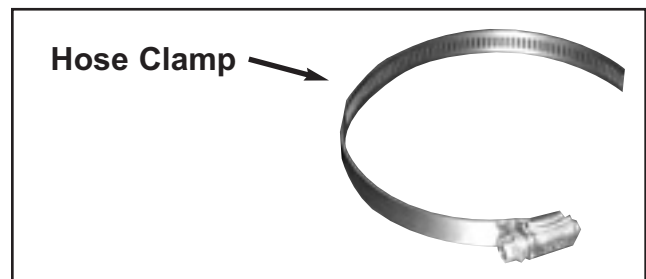
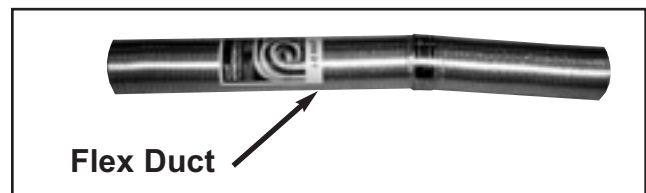
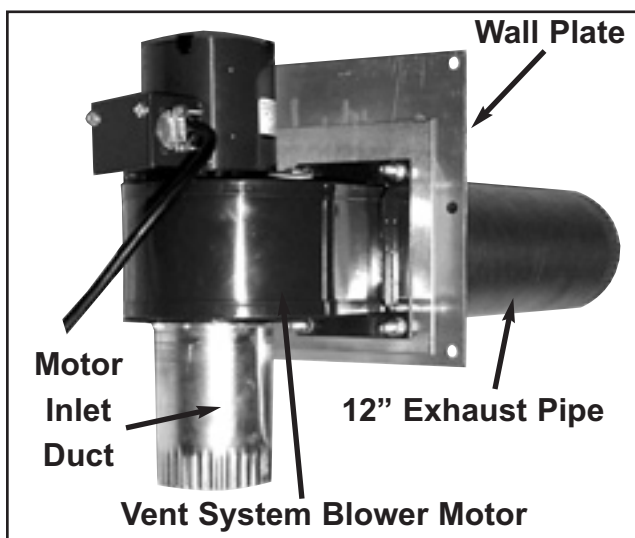
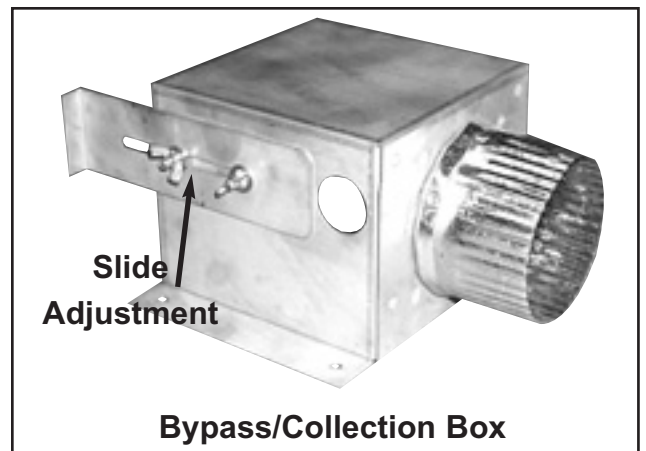
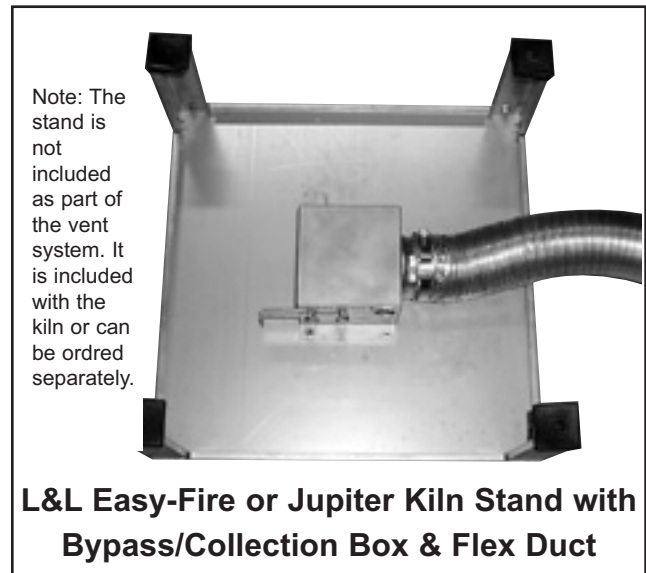

L&L VENT-SURE DOWNDRAFT KILN VENT SYSTEM

FEATURES AND SPECIFICATIONS

ADJUSTABLE AMOUNT OF VENTING

A sliding adjuster on the vent Bypass Collection Box adjusts the amount of venting from the system (see photo on page 3). Vent only what you need to vent - don't waste heat and energy by venting more than you need.

EXTERNAL VENTING

External venting is safer and surer than venting to the inside of your kiln room with a filter.

REMOTE MOUNTING OF MOTOR

The vent blower motor is mounted to a wall plate with a 12" length of exhaust pipe that mounts on the wall (see photo). This keeps the heat of the kiln away from the motor (for longer motor life) and keeps the motor vibration away from the kiln. (With the special "Multi-Mounting Bracket" the vent motor may be mounted on the floor or a wall with the outlet pointing up and then connected to an existing vent system or 4" wall outlet. If you decide to mount it this way see the caution on page 5).

MOUNTS ON ANY KILN

The Vent-Sure vent system can be installed on almost any kiln. It requires only that you drill several small vent holes through the kiln wall (or floor) and four mounting holes to mount the bypass collection box to the kiln wall (note that if mounting the bypass/collection box to the stand, that four studs are factory installed on the bottom of the new stand that L&L is using as of 3/2000, see photo on next page). Mounting hardware is included. You can also order one of L&L's heavy-duty aluminized stands to mount the vent on and support your kiln. (See the separate PDF file www.hotkilns.com/vent.pdf).

POWERFUL VENT MOTOR

The blower vents up to 146 CFM (cubic feet per minute at 0 static pressure and 110 CFM at 0.500-In. static Pressure). Remember - not all of this air comes from the kiln - some comes from the Bypass Collection Box.

OUTLET TEMPERATURE UNDER 150°F

The outlet temperature of the air is less than 150°F as

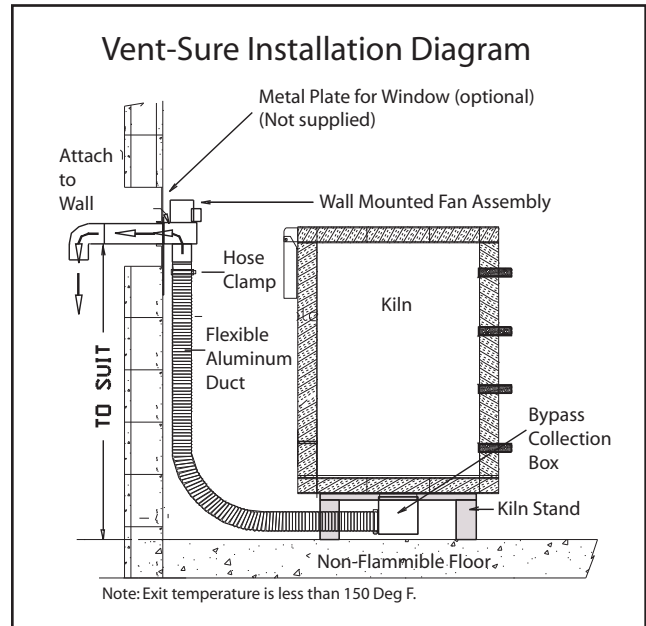

long as you do not exceed the recommended holes in the kiln.

FLEXIBLE DUCT INCLUDED

15 feet of flexible expandable aluminum 3" diameter duct is included along with necessary hose clamps. Longer lengths or lengths of 3" stove pipe can be used as well.

LOW ELECTRICITY USAGE

The Vent-Sure vent System uses only 0.75 amps.

VENTS UP TO 20 CUBIC FEET OR MORE

The Vent-Sure vent System was designed to be used with all L&L model kilns. We recommend one vent system for kilns up to approximately 20 cubic feet. On larger kilns, depending on how much venting you need, you may need more than one vent system. (This really depends on how much venting you need for your situation). Even our largest 35 cubic foot DaVincis have usually been adequately vented with one Vent-Sure. Note that you can always add another vent if you find you need more venting.

L&L VENT-SURE DOWNDRAFT KILN VENT SYSTEM

INSTALLATION

IMPORTANT CAUTION

MAKE CERTAIN KILN POWER IS OFF BEFORE PROCEEDING WITH INSTALLATION.

Step 1. Turn Off Kiln Power

This is critical for safety reasons.

Step 2. Install Bypass/Collection Box

If mounting on a new L&L kiln stand, simply place the box on the studs on the bottom of the kiln stand and tighten with the provided nuts (and lock washers). If you are mounting the box on a section of the kiln, position the bypass/collection box in desired location, mark the four mounting hole locations with a marker, move the box and drill the 4 holes with a 1/16" drill bit.

Next you will drill the venting hole or holes through the floor or the kiln section. Note that this is already done on kilns that come from the factory ordered with the Vent-Sure vent system. See the chart in these instructions for the number of holes. If you later decide that that you want more or less ventilation, you can add or plug the holes accordingly. Be conservative. It is easier to add holes than plug them up (although that can be done with a brick repair kit). If mounting the box on a kiln section, be sure not to drill through a element holder. To prevent this, measure down on the inside of the kiln ring, then mark holes on the outside to clear the holders, then drill.

Attach the box to the kiln section using the provided hardware.

The Bypass Collection Box is mounted to the bottom of the stand with provided hardware.

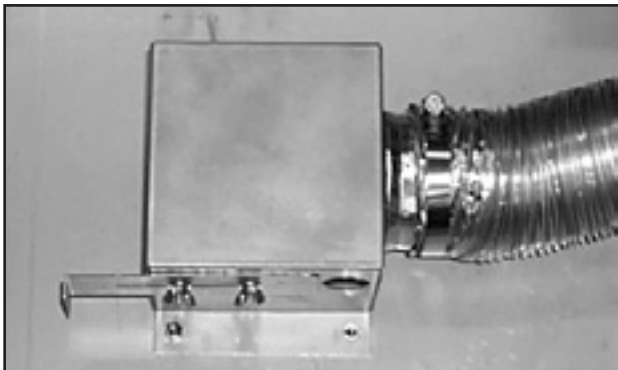

Step 3. Install Blower System

Install blower system by penetrating outside wall or setting into a window with appropriate support. Attach the provided 90 degree elbow to point down on the outside of the building (this is to prevent rain water from getting into the duct). (Note: this procedure will change if you use the Multi-Mount bracket). Mount securely because motor may vibrate over time especially if it builds up any dust in the blower.

The motor assembly comes pre-mounted onto the Wall mount bracket:

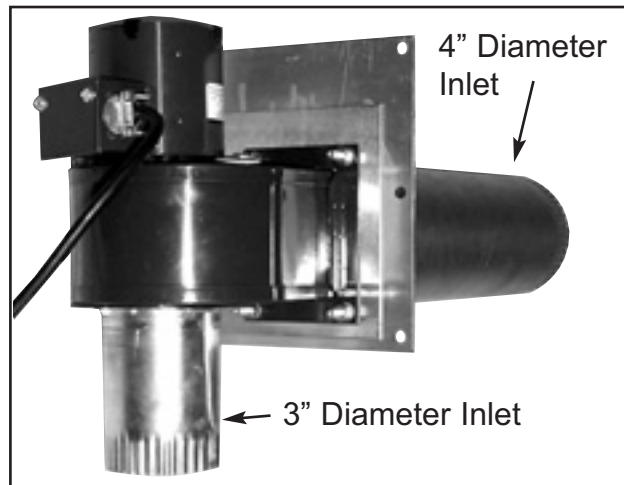

CAUTION: Make sure that the vent outlet is at least four feet from any open windows or doors. This is to make sure hazardous fumes do not get back into your building. Also the fumes can be hazardous to plants within a few feet.

A CAUTION ABOUT MOUNTING VERTICALLY

If the discharge duct of the vent is mounted pointing up (as shown on the photograph of the Vent-Doubler system) water that condenses in the duct may drop down and rust the motor. We recommend having a water trap in the bottom of a vertical duct run to drain off the water before it runs into the motor. This is not a problem when the vent has been mounted horizontally. The Multi-Mount bracket will allow you to mount the motor horizontally as well. You can then use 90 degree bends or flexible duct to go vertically. Just remember that there is water in the exhaust that will condense somewhere as it cools after it discharges from the vent motor.

L&L VENT-SURE DOWNDRAFT KILN VENT SYSTEM

A special Multi-Mount bracket is available from L&L for \$20 which will allow you to mount the vent on the floor or wall with the outlet of the vent pointing up. This is useful when you want to use an existing penetration in a wall that won't support the vent (like a window) or when you want to have the vent go out of a roof or into a central vent system.



Step 4. Connect Flexible Duct

Attach blower system to bypass/collection box by stretching the flexible aluminum duct carefully (it can extend up to 15 feet) and securing to both the blower housing and the bypass/collection box with the provided hose clamps. **NOTE: You may want to firmly attach this to the Bypass Collection Box before installing the kiln on the stand because it can be hard to maneuver under the kiln.**

Step 5. Plug In Vent

Plug in the switched cord to a standard 120 volt receptacle. **If need be you can safely use a grounded extension cord because of the small amperage required.** Be sure to secure cord away from heat of kiln.

ROOM AIR REPLACEMENT

ROOM AIR REPLACEMENT:

The Vent-Sure system moves up to 130 cubic feet of air per minute. We suggest opening a window slightly, or bringing other fresh air source into the room, to replace this room air.

INSTALLATION OF MULTIPLE VENTS

VENT DOUBLER SYSTEM

This shows a photograph of the Vent Doubler System available from L&L:



The Vent Doubler system includes a bracket for mounting the vent motor on the floor or wall (as shown), an extra Bypass Collection Box, an extra Flexible Aluminum Duct and a "T" Connector with dampers. You can vent two 10 cubic kilns with one Vent-Sure plus this Vent Doubler System.

CENTRAL VENT SYSTEMS

Multiple Vent-Sure systems may be installed individually, or each system may be connected to a central duct. The following information is provided to help the installer make decisions concerning the size and length of the central duct.

CENTRAL DUCT SIZING

QTY OF SYSTEMS	SIZE OF CENTRAL DUCT
1	4"
2	6"
3	8"
4	8"
5	10"
6	10"

EXTENDING DUCT LENGTH

The duct may be 60 feet in length, and include up to four 90° bends, without a significant drop in static air flow or a reduction in kiln air pull. You may use any galvanized, stainless or aluminum duct. The outlet duct size (after the motor) is 4" diameter. The inlet duct (before the motor) is 3" diameter.

L&L VENT-SURE DOWNDRAFT KILN VENT SYSTEM

TYPICAL NUMBER AND SIZE OF HOLES TO BE DRILLED IN L&L KILNS

MODEL	CUBIC FEET	NO OF HOLES	HOLE DIAMETER
GS1714	1.7	1	1/4"
e23S	4.7 Cu Ft.	2	1/4"
e23T	7.0 Cu Ft.	2	1/4"
e28S	6.9 Cu Ft.	2	1/4"
e28T	10.3 Cu Ft.	3	1/4"
J18	2.6 Cu Ft.	1	1/4"
J18X	3.9 Cu Ft.	1	1/4"
J23	4.7 Cu Ft.	2	1/4"
J230	7.0 Cu Ft.	2	1/4"
J236	9.4 Cu Ft.	3	1/4"
J245	11.75 Cu Ft.	3	1/4"
J2918	6.9 Cu Ft.	2	1/4"
J2927	10.3 Cu Ft.	3	1/4"
J2936	13.8 Cu Ft.	4	1/4"
J2945	17.2 Cu Ft.	5	1/4"
X1818	3.4 Cu Ft.	1	1/4"
X1827	5.1 Cu Ft.	2	1/4"
XB2318	5.0 Cu Ft.	2	1/4"
X2327	8.1 Cu Ft.	2	1/4"
X2336	10.8 Cu Ft.	3	1/4"
X2345	13.5 Cu Ft.	4	1/4"
XB2818	7.8 Cu Ft.	2	1/4"
X2827	11.7 Cu Ft.	3	1/4"
X2836	15.6 Cu Ft.	4	1/4"
X2845	19.5 Cu Ft.	3	5/16"
XB3218	10.0 Cu Ft.	3	1/4"
X3227	15.0 Cu Ft.	4	1/4"
X3236	20.0 Cu Ft.	3	5/16"
X3245	25.0 Cu Ft.	4	5/16"
TB2318	9.7 Cu Ft.	3	1/4"
T2327	14.6 Cu Ft.	4	1/4"
T2336	19.4 Cu Ft.	3	5/16"
T2345	24.3 Cu Ft.	4	5/16"
TB3418	13.8 Cu Ft.	4	1/4"
T3427	20.7 Cu Ft.	3	5/16"
T3436	27.6 Cu Ft.	5	5/16"
T3445	34.5 Cu Ft.	6	5/16"

OPERATION

Plug blower cord into 120 Volt receptacle. Close all kiln apertures such as peepholes, etc. (See important caution regarding this on page 3). Close the lid and fire. For heavy loads with lots of fumes you may want to avoid firing faster than 150°F per hour to prevent the generation of more fumes than the system can eliminate. Use the flow control on the Bypass Box to modify the flow of exhaust - a larger flow control opening reduces the flow of exhaust fumes from the kiln, and a smaller flow control opening increase the exhaust.

IMPORTANT CAUTIONS

CAUTION: Check duct occasionally to see if there is wax or other residual build up. Wax could condense in the duct, which is a potential fire hazard. This is especially important if you are using a wax resist.

CAUTION: Be sure that the exhaust of the vent is not being brought back into your building. Keep exit of vent at least four feet away from any open windows or doors.

CAUTION: We recommend the use of a carbon monoxide monitor in your kiln room. These are available from good hardware stores, Graingers or Home Depot for about \$50 (This is another good way to be sure you are getting proper venting).

CAUTION: Disconnect power cord from power source when doing any maintenance on the fan motor. Do not put your fingers inside the blower without disconnecting power. Blower may start unexpectedly because of automatic thermal shut off switch built into the motor.

ADJUSTING THE BYPASS SYSTEM

The sliding adjuster allows you to fine adjust the amount of venting that is done to your kiln. It is easy to adjust but hard to know just how to adjust it. The problem is that there are many factors that contribute to the amount of "pull" required. For instance, the amount of fumes that are being given off by your specific work is one factor. Some clays have a lot of carbon in them; others do not. Depending on the size of the load, and the ingredients in the clay/glaze, there

L&L VENT-SURE DOWNDRAFT KILN VENT SYSTEM

will be more or less fumes generated. Another factor is the "static pressure" in your vent ducts. If you have a lot of curves, 90 degree bends, or long runs of duct this will increase the static pressure (back pressure) and hence increase the need for more venting force. One suggestion is to start with the valve in the half open position and see what happens.

The Smell Method:

To some extent you can go by fumes that you smell. However, carbon monoxide is odorless. You should get a carbon monoxide warning alarm for your kiln room in any case so if this goes off you will know you need more venting. Also, if the kiln is in a damp spot, the bricks can absorb moisture, and grow some mold.

The mold will burn off, and you would smell it burning. As soon as the kiln goes on, you may well smell stuff that can't be taken away by the vent, and you won't be able to prove it's not a faulty vent. Smell is therefore not a foolproof method to verify the success of a vent.

Industrial Point of View:

A typical rule of thumb for purging panels of hazardous fumes (in explosive environments) is four volume changes of air per hour. This seems intuitively the same for fumes in a kiln. However, there is no easy way to measure these volume changes and we mention this fact as a point of reference only.

The Smoke Method:

- 1) With power disconnected from the kiln and with the kiln empty, turn the vent on.
- 2) Start with the bypass valve in the fully closed position. This will give it the maximum suction in the kiln.
- 3) Light a piece of paper on fire or something that will create smoke. Blow it out, and hold it near the cracks around the closed lid.
- 4) If the smoke is being pulled into the kiln around these door cracks, open the Bypass (decreasing flow from the kiln) until the smoke stops being pulled in, then back up the valve slightly, so the draw increases just slightly again. Try this when kiln is at about 100 deg F.

5) You can do the same test directly at the bottom hole with the kiln open also to test the differential between the pull at the actual suction hole from the kiln and the pull around the lid.

For Gross Adjustment:

Remember that the sliding adjuster is for fine adjustment. Drilling or plugging the holes in the floor (and possibly adding or plugging holes in the top) is how you would dramatically change the amount of air vented.

VENTING CODES

The following information is provided courtesy of The Edward Orton Jr. Ceramic Foundation.

OSHA has set standards for carbon monoxide exposure of 35 ppm (parts per million) for long-term exposure and 200 PPM for short-term exposure. Independent testing has shown that fumes near the kiln can exceed 200 PPM near the kiln during the firing of greenware. This can cause headaches, fatigue, sore throats and nausea. When properly installed and operated, a downdraft vent removes all harmful fumes and provides a safer working environment.

Most states and localities have set venting requirements for firing kilns in public places. Your local and state health board should have this information. The Uniform Mechanical Code says that you must vent ceramic kilns. It says that you can use a canopy-type hood (and gives specific requirements for such use) or that "listed exhaust blowers may be used when marked as being suitable for the kiln and installed in accordance with manufacturer's instructions." Our Vent-Sure vent is UL listed and is appropriate to meet this ventilation requirement. L&L takes no responsibility for improperly installed vents or kilns nor do we take responsibility for the use of other vents with our kilns.

L&L VENT-SURE DOWNDRAFT KILN VENT SYSTEM

REGULAR MAINTENANCE

Occasionally check for leaks in the aluminum duct. Replace if necessary. Check for corrosion especially if you are using clay with a high content of sulfur, phosphorus or fluorine. Check for wax or carbon build up if you are using a wax resist process or a high carbon content clay.

We recommend unmounting the fan and blowing out the squirrel cage with compressed air every two years or so especially if you are in a very dusty or if you have it mounted on the floor where it is more likely to pick up dust.

If the discharge duct of the vent is mounted pointing up you may get water that condenses in the duct drop down and rust out the motor. Taking it apart and spraying with WD-40 can restore the motor in some cases. We recommend having a water trap in the bottom of a long vertical duct run to drain off the water before it runs into the motor. This is not a problem when the vent has been mounted horizontally.

FREQUENTLY ASKED QUESTIONS

The following Frequently Asked Questions are provided courtesy of The Edward Orton Jr. Ceramic Foundation. L&L licenses the downdraft technology from Orton and many of the operating characteristics of the vent systems are similar. The main differences are that the L&L Vent-Sure kiln vent system has an externally mounted blower, which keeps the vent blower away from the kiln. This eliminates the chance of vibration affecting the kiln and ware, extends blower life and keeps the vent duct under vacuum instead of pressure. Our blower is also more powerful. We add our own comments in parenthesis below.

How do I determine the size, number and location of holes in the top and bottom of the kiln?

As a general rule, you should have one 1/4 inch hole for every 4 cubic feet of kiln volume. The holes are normally placed within a 4 inch circle in the center of the kiln floor. The same number of holes is used in the top of the kiln, but they are placed about 1 inch in from the inner edge of the kiln wall. (L&L NOTE: L&L does not normally recommend drilling holes in the top like Orton does. Also see our hole chart on

page 7 which is specific to our kilns).

How do I know if the system is working?

The easiest way to test the operation of the vent system is to turn the unit on and to place a lighted match directly over and level with one of the holes in the lid of the kiln. The flame from the match should be gently pulled into the kiln as a result of the draft. (L&L NOTE: See our comments under "Adjusting the Bypass Valve").

How hot does the duct get during the firing?

Due to the introduction of fresh air through the plenum of the vent system mixing with the hot gases being drawn from the kiln, the temperature of the duct of the duct is below 150°F. This will prevent burns from occurring in the event of the duct being touched. (This is also true for the Vent-Sure - even more so because we are pulling a higher volume of air through the Bypass Valve).

How long can the duct be and how many bends can it have?

Up to 60 feet of ducting containing four 90 degree bends may be safely used with no drop in static air flow at the duct exhaust point or a reduction in draw at the kiln. The ducting can be run either horizontally or vertically. (The Vent-Sure should handle more static pressure than the Orton vent because of the stronger motor. This translates into longer lengths of pipe and more 90 degree bends. If you have a choice run two 45 deg bends rather than one 90 degree bend or use flexible duct which has a gentler bend).

Do I need double wall duct when going through the roof?

You do not normally need double wall ducting when going through the roof since the pipe or duct does not reach high temperature. It is always advisable to check your local building codes for their requirements.

What type of duct do I use if I need more than 8 feet?

You can use more of the flexible aluminum dryer ducting or you can use galvanized furnace ducting. We have also had people using "pvc" plastic piping with good results. (L&L NOTE: L&L does not recommend PVC pipe. We recommend using 4" diameter galvanized duct).

L&L VENT-SURE DOWNDRAFT KILN VENT SYSTEM

Will the fumes coming through the vent damage my plants, the neighborhood pets or disturb the local environment?

No. The fumes and the gases coming from the kiln have been diluted with enough fresh air to make them safe for the environment. (L&L NOTE: Do not, however, place the outlet of the vent below an open window. Also we have heard of plants near the vent outlet being affected by the vent fumes so keep this in mind when locating vent outlet).

Will using the vent cause my firing to take longer?

The vent system pulls only a very small amount of air out of the kiln, so very little heat is removed and firing times will change very little. For some kilns, a high firing may take a little longer. The insulation value and the number of air leaks in the kiln also determine the length of the firing. (L&L NOTE: We have seen vents overpower smaller kilns - so it is important to adjust the amount of venting in some cases. On the other hand an example of an e23T 7 cubic foot kiln firing an 85 pound load on Fast Glaze program to cone 8 took 7 hours and 4 minutes with a vent on and 6 hours and 24 minutes without a vent. The vent was on the whole time).

What does it cost to operate the vent system?

The vent system typically costs less than 1 cent/hour to operate (electricity costs). Vent systems save on heating and cooling costs when compared to hoods. Hoods remove massive amounts of air from the kiln room - air that may have been heated or cooled, depending on the time of year. Downdraft type vents remove 80% less air in the kiln room than does a hood. (It does cost more to run the vent because it does take heat out of the kiln. For example an e23T 7 cubic foot kiln firing an 85 pound load on Fast Glaze program to cone 8 took 70 KW hours with a vent on and 62 KW hours without a vent. At 8 cents per KW hour that would be a cost of \$0.64. The vent was on the whole time).

Will the cold air entering the kiln damage the product?

The amount of air that is entering the kiln is so small that it does not cause problems with the ware. The top holes are placed toward the outside of the chamber area so that no air comes down directly onto ware that is placed near the top of the kiln. (L&L NOTE: This is fine but we do not normally recommend holes in the lid).

Will faster cooling crack the ware if I leave the vent on during the cooling Cycle?

No. Some kilns can cool an average of 4-1/2 hours faster with the use of the vent system. The cooling is faster but it is taking place at an even rate throughout the kiln avoiding uneven stresses being placed on the ware. Most ceramic ware can be cooled more quickly if the cooling takes place at an even rate. The rate of cooling increase will depend on the kiln size and the density of the load. (L&L NOTE: The vent will remove more molecules of air and hence heat as the kiln cools. This is because the density of the air increases the lower in temperature you go. This is one reason why kiln vents are so efficient - they don't remove too much heat when you don't want them too at the higher temperatures).

What should I do if I still smell fumes?

You should check your ductwork to make sure it is properly connected and that the joints are sealed. You can also check for extra air leaks around your kiln and repair these if necessary. (L&L NOTE: See our comments on "Adjusting the Bypass System").

L&L VENT-SURE DOWNDRAFT KILN VENT SYSTEM

PARTS

Complete Vent-Sure Kiln Vent System

M-V-VENT/00\$440.00
VENT-SURE Vent. Complete System as described above and on our separate **Vent-Sure** brochure. This includes the motor, an 8 foot cord with a rocker type On/Off switch mounted in line in the cord, the inlet duct attached to the motor, the wall mounting bracket, a 90 deg elbow for mounting on the end of the outlet pipe (to keep rain water out), the Bypass Collection Box for attaching to the kiln stand or kiln side along with mounting hardware for mounting to an L&L kiln stand and one section of 15 foot flexible aluminum duct with hose clamps.

You can also purchase individual parts to suit your own configuration or as replacements:
Below shows the vent system blower assembly with the motor, cord and switch set, 3" inlet duct to hold the flexible duct, 12" duct to go through a wall and 90 Degree elbow.

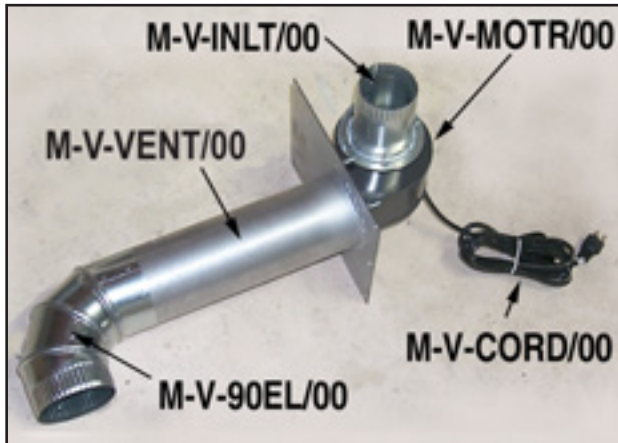

M-V-FAN0/00\$220.00
Fan/Blower Motor for Vent-Sure. This is just the motor with no attached brackets or inlets. Cord is not included.

M-V-BRKT/00\$82.00
Wall mount bracket that goes through wall and onto which the fan motor mounts. (Note: This will also attach to the Multi-mounting bracket (M-V-BRCK/00) if you want to mount the vent on the floor or on the wall with the outlet pipe going up.

M-V-INLT/00\$25.00
Motor Inlet Duct. This is the piece of duct that attaches to the inlet of the motor. The expandable aluminum duct fits onto this.

M-V-90EL/00\$9.25
90 Deg 4" elbow. Used for attaching to motor mount duct to the outside to prevent water from getting into duct.

M-V-DUCT/00\$31.00
Flexible Vent Duct 2-1/2 to 15 Feet Expandable, Flexible Aluminum 3" duct with two hose clamps.

Flexible Aluminum Duct shown with hose clamps:



M-V-BBOX/00\$62.00
Bypass Collection Box. Includes hardware for mounting and slide control. Note: This has the proper mounting hole configuration to be mounted to any L&L kiln stand. It can also be mounted to the side of other kilns (typically on the bottom section).

Bypass Collection Box:

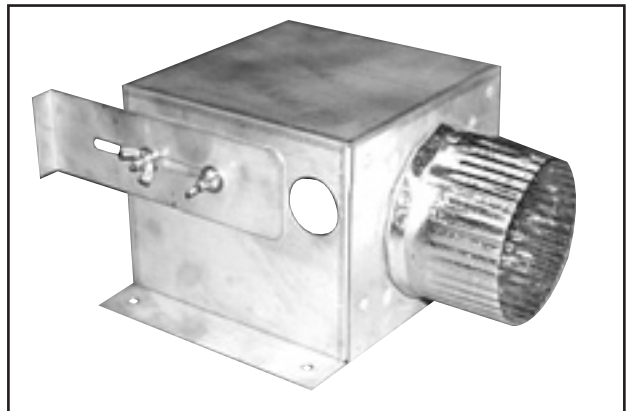

M-V-CORD/00\$48.00
Power Cord for Vent-Sure. Includes a cord mounted on/off switch.

Power Cord with On/Off switch:



L&L VENT-SURE DOWNDRAFT KILN VENT SYSTEM

M-V-MULT/00\$22.00
Multi-Mounting Bracket. Comes with six (6) sets of 1/4-20 bolts, nuts and lock washers for mounting this to the "Wall mount bracket" (M-V-VENT/BK).

This special "Multi-Mounting Bracket" will allow you to mount the vent on the floor or wall with the outlet of the vent pointing up. This is useful when you want to use an existing penetration in a wall that won't support the vent (like a window) or when you want to have the vent go out of a roof. There are mounting holes on the bottom (for floor mounting) and on the side as well (for wall mounting):

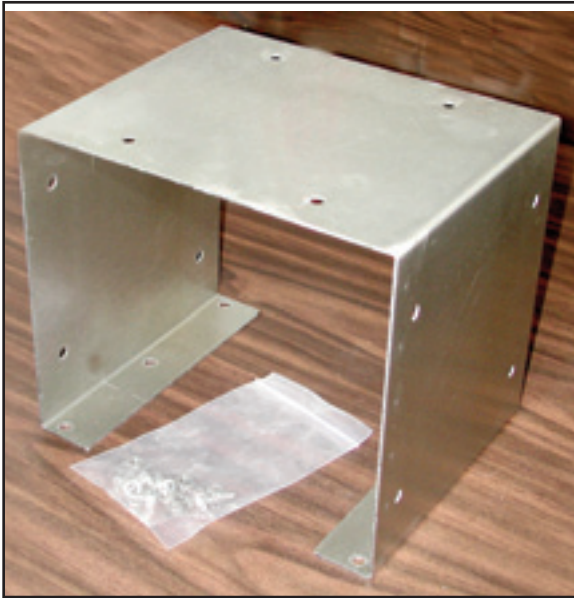

M-V-VENT/DB.....\$135.00
Vent Doubler System for Vent-Sure. Includes a "T" duct with dampers, an extra Bypass Collection Box, Extra Flexible Duct and the Multi-Mount Bracket.

Vent Doubler System:

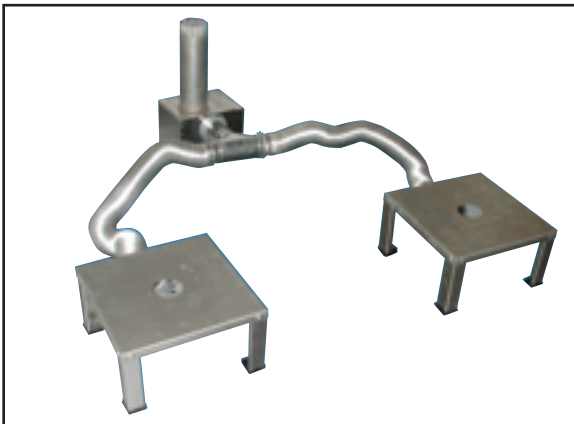

M-V-TDUC/00\$43.00
"T" DUCT to attach two aluminum flexible ducts to. Includes dampers on the two inlets. The outlet fits onto the Motor Inlet Duct of the Vent-Sure and the Flexible Vent Duct(s) fit onto the inlets of this "T" Duct.

Special "T" duct for doubler system:



DURA-FIRE INSTRUCTION MANUAL



L&L Kiln's patented
hard ceramic
element holders
protect your kiln.

SETTING UP THE DAWSON KILN SITTER ON YOUR L&L KILN

WHERE THE DAWSON KILN SITTER IS USED ON L&L KILNS

The Dawson Kiln Sitter is used on all manual Jupiter and DaVinci kilns as the primary control device. It is also used as a back up safety system on Jupiter and DaVinci Automatic kilns. When used as a back up it is typically used to shut off the kiln only if the automatic control fails. NOTE: For backup systems be sure to put a higher cone in the Dawson than you are setting your Automatic control to fire to.

Step 1.

Remove the factory installed screws and spacers from the kiln section. There are four screws with three spacers per screw.

Step 2.

Place the Tube assembly into the factory drilled hole in the kiln section. Make sure that the provided washer and washer clip are on the tube assembly before inserting.

Step 3.

Place a screw through one of the Dawson mounting ears. Place three of the 1/2" ceramic spacers over the screw insert the tip of the screw into the hole in the kiln section and tighten (do not tighten all the way until all the screws are in). Repeat the process for the remaining three screws.

Step 4.

Complete the tightening of the screws. Push the washer flush against the face of the kiln section and push the washer clip against the washer to keep it in place.

Step 5.

Refer to your supplied Dawson Sitter Timer Manual for adjustment and operation instructions.



**One Screw & Three
1/2" Ceramic spacers**

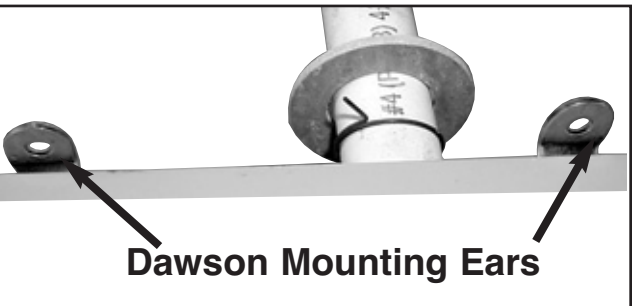
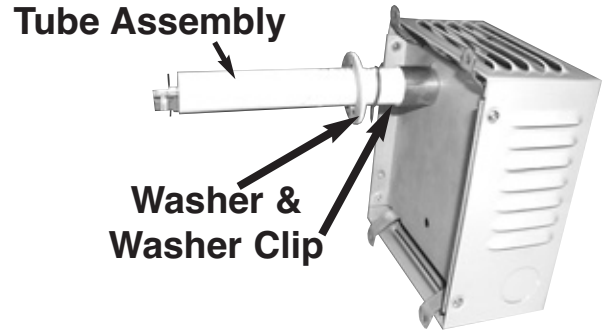

ASSEMBLY INSTRUCTIONS FOR L&L EASY-FIRE KILNS

TABLE OF CONTENTS

TOOLS NEED FOR THE JOB	1
UNPACKING	2
Inspect for visible damage	2
Contents of the shipment	2
Remove Top from Carton	3
Unpack Instructions, Vent and Furniture Kit	3
Unpacking the kiln	4
ASSEMBLING THE STAND	6
DISENGAGING THE SPRING HINGE AND REMOVING THE LID	6
REMOVING THE HINGE	9
REMOVING THE CONTROL PANEL AND ELEMENT COVER AS ONE ASSEMBLY	9
REMOVING THE CONTROL BOX	11
REMOVING ELEMENT COVER BOX	12
LOCATING THE KILN	13
SETTING UP THE KILN	13
SETTING UP THE HINGE	14
ADJUSTING THE SMALL NON-SPRING HINGE	17
REASSEMBLING THE CONTROL PANEL	18
If you removed the panel separate from the element cover box	18
REATTACHING CONTROL BOX	20

VIDEOS OF SELECT PROCESSES CAN BE FOUND ON YOUTUBE AT:

www.youtube.com/LLKilns

TOOLS NEED FOR THE JOB

You will need the following tools for the job:

- 1) Philip's head screw driver (medium size head)
- 2) Knife
- 3) Needle Nose pliers
- 4) Adjustable Wrench
- 5) Level
- 6) Safety Gloves

WHAT SHOULD YOU READ?

The information in these installation instructions is as complete as we can make it - which means that there is more than most people will need to read. Each heading is self-contained (for instance "Assembling the Stand") Most people will be able to figure out how to assemble their stand by looking at it - so only read this heading if you get stuck.

First of all be comfortable with where you are putting your new kiln. If you have any questions about that read the information about clearances, ventilation, etc. in the "Installation" section. Do that first so you don't have to redo your work.

If there is anything we feel you must read we will call it to your attention with one of these shaded boxes.

CAN YOU MOVE THE KILN WITHOUT DISASSEMBLING IT?

The kiln is shipped mostly assembled (except for the stand). It is possible to move the kiln without disassembling it. However, these kilns, particularly the e28S and e28T, are very heavy and awkward to move. If you decide to move it without disassembling the sections first be absolutely certain you have at least two or three strong people who are familiar with proper lifting techniques. Serious back injury could result if such a heavy object is lifted improperly. See page 9 for details on how to do it - there are specific instructions depending on which model you have.

CAUTION: Do *NOT* attempt to disengage the spring hinge without first reading the detailed instructions as listed on pages 7-8.

ASSEMBLY INSTRUCTIONS FOR L&L EASY-FIRE KILNS

UNPACKING

Inspect for visible damage

The carton should arrive without visible damage. If the carton was damaged in transit, you should either refuse shipment or unpack the kiln in the drivers presence in order to file a damage report with the freight company.

Call our office immediately if there is a problem. SAVE ALL MATERIALS UNTIL YOU ARE SURE YOU WON'T NEED THEM. AT THE VERY LEAST NOTE DAMAGE ON THE BILL- OF-LADING - WITHOUT THIS YOU HAVE NO PROTECTION!

Below is a picture of how your kiln should arrive: (Note that the below picture shows a kiln as ordered with a furniture kit and vent)



Unpack Instructions, Vent and Furniture Kit

1) Remove the two separate Furniture Kit and Vent-Sure vent system boxes, if ordered, from the top of the kiln carton.

2) If you ordered a Vent-Sure vent system you will find the following items inside the cardboard box:

- flexible ductwork
- bypass collection box
- galvanized 90 degree elbow
- vent motor with mounting bracket and duct attached for venting through a wall.

3) If you ordered the standard Furniture/Accessory kit you will find the following:

For an e18S:

- One 15-1/2" full round shelf
- four 15-1/2" half shelves
- six each 1/2", 1", 2", 4", 6" and 8" square posts
- five pounds of Cone 10 kiln wash
- a pair of temperature resistant gloves

e18S-3:

- One 15" full round shelf
- four 15" half shelves
- six each 1/2", 1", 2", 4", 6" and 8" square posts
- five pounds of Cone 10 kiln wash
- a pair of temperature resistant gloves

For an e18T:

- two 15-1/2" full round shelves
- four 15-1/2" half shelves
- six each 1/2", 1", 2", 4", 6" and 8" square posts
- five pounds of Cone 10 kiln wash
- a pair of temperature resistant gloves

For an e18T-3:

- two 15" full round shelf
- four 15" half shelves
- six each 1/2", 1", 2", 4", 6" and 8" square posts
- five pounds of Cone 10 kiln wash
- a pair of temperature resistant gloves

For an e23S:

- One 21" full round shelf
- four 21" half shelves
- six each 1/2", 1", 2", 4", 6" and 8" square posts
- five pounds of Cone 10 kiln wash
- a pair of temperature resistant gloves

ASSEMBLY INSTRUCTIONS FOR L&L EASY-FIRE KILNS

For an e23S-3:

- a) One 20" full round shelf
- b) four 20" half shelves
- c) six each 1/2", 1", 2", 4", 6" and 8" square posts
- d) five pounds of Cone 10 kiln wash
- e) a pair of temperature resistant gloves

For an e23T:

- a) two 21" full round shelves
- b) four 21" half shelves
- c) six each 1/2", 1", 2", 4", 6" and 8" square posts
- d) five pounds of Cone 10 kiln wash
- e) a pair of temperature resistant gloves

For an e23T-3:

- a) two 20" full round shelf
- b) four 20" half shelves
- c) six each 1/2", 1", 2", 4", 6" and 8" square posts
- d) five pounds of Cone 10 kiln wash
- e) a pair of temperature resistant gloves

For an e28S-3:

- a) six 26" half shelves
- b) six each 1/2", 1", 2", 4", 6" and 8" square posts
- c) five pounds of Cone 10 kiln wash
- d) a pair of temperature resistant gloves

For an e28T-3:

- a) eight 26" half shelves
- b) six each 1/2", 1", 2", 4", 6" and 8" square posts
- c) five pounds of Cone 10 kiln wash
- d) a pair of temperature resistant gloves

NOTE: Furniture Kits can be ordered to come with all half shelves at no extra charge. If you ordered your kit this way then there will be twice as many half shelves as there are full shelves listed above, plus whatever amount of half shelves already listed.

Below is a picture of the cardboard box with a Vent-Sure system enclosed. NOTE: Depending on where you bought your kiln, your vent system and/or kiln furniture may arrive packed differently.



Below is how the cardboard box with a Furniture Kit enclosed should look upon opening.



Remove Top from Carton

- 1) Remove the packing slip from the packing list enclosed envelope.
- 2) Cut the banding around the kiln box.
- 3.) With a screw driver pry off the staples holding the top of the box to the box sleeve and remove the top.

ASSEMBLY INSTRUCTIONS FOR L&L EASY-FIRE KILNS

Below is the first thing you will see when you open the box - foam tubes securing the kiln:



Unpacking the kiln

- 1) With a screw driver pry off the staples holding the bottom box tray to the box sleeve.
- 2) Next remove the cardboard inset from the carton, and remove the carton sleeve from the skid.
- 3) The heavy duty kiln stand containing a white box, or manilla envelope, with the stand legs positioned around it will be set on top of the kiln. This will be slightly covered by the foam packaging tubes.

Interior packaging with the inset removed:



- 4) Push the foam tubes away from the kiln body. If desired, these can be completely removed by using a knife to carefully cut the plastic tubing by the base of the kiln. There should be little to no foam there. Be careful not to scratch the kiln with your knife.

Removing foam tubes:



- 5) Carefully cut off the stretch wrap that is around the kiln. Be careful not to scratch the kiln with your knife.

ASSEMBLY INSTRUCTIONS FOR L&L EASY-FIRE KILNS

Carefully cut off shrink wrap:



6) Remove the kiln stand base from the top of the kiln. The kiln manual, in a white cardboard box or manilla envelope, surrounded by the four kiln stand legs should be resting within the edges of the kiln stand base.

Removing the kiln stand:



7.a) If you ordered an e18S, e18T, e23T, or e28T your kiln floor will be on top, remove it now.

CAUTION: Do *NOT* attempt to disengage the spring hinge without first reading the detailed instructions as listed on pages 7-8.

Removing the kiln base:



7.b) If you ordered an e23S or e28S the floor of the kiln will not be on the top, it will be on the bottom of the kiln as it helps secure the spring hinge bracket which is assembled for shipping.

NOTE ABOUT e18S & e18T SERIES KILNS:

These kilns employ simple hinges, thus the kiln base will always be packed on top.

The base as attached to the hinge bracket:



8) Notice that the spring on your spring hinge *IS* engaged and in working condition.

ASSEMBLY INSTRUCTIONS FOR L&L EASY-FIRE KILNS

ASSEMBLING THE STAND

Next, using the enclosed stand hardware, assemble the kiln stand. If ordered, also use the vent system components and hardware to finish assembly of the kiln stand.

1) Assemble the stand legs. **Make sure all the stand legs are tight.** Use a nut driver or an adjustable wrench to do this. NOTE: If you did not order a vent then your stand is completely assembled after this step.

Each leg gets bolted to the stand with two 1/4-20 bolts provided. They do not need nuts:



2) Attach the flexible vent tube to the outlet of the vent collection box. It takes some patience to get the flexible tube around the fitting. Tighten the Breeze clamp to secure the duct to the outlet.

Installing the flexible duct onto the bypass collection box of the vent-sure vent system:

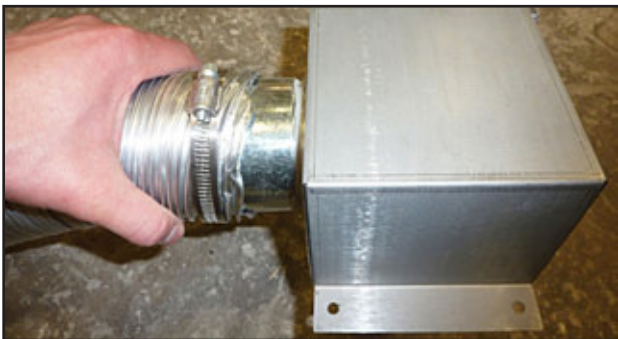

3) Attach the bypass collection box using the studs that are secured to the bottom of the stand and the supplied mounting hardware, four 10-24 nuts and lock washers.

The bypass collection box fits over four studs on the bottom of the stand. The lock washers are used between the bypass box flanges and the nuts:

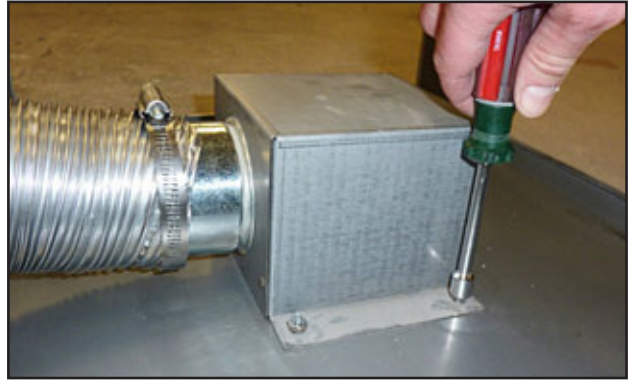

The fully assembled stand:



DISENGAGING THE SPRING-HINGE AND REMOVING THE LID

The next step is to remove the lid from the kiln which can only be done once the spring hinge has been disengaged.

The hinge is shipped assembled (with the spring engaged). This way you can see how it all goes back together:



1) Unclasp the latch underneath the lid handle and open the kiln lid to its fullest extent.

ASSEMBLY INSTRUCTIONS FOR L&L EASY-FIRE KILNS

The kiln with the lid opened:



2) Remove one of the cotter pins from the top-most hinge bar that only goes through the lid bracket.

Removing a cotter pin from the top-most bar:

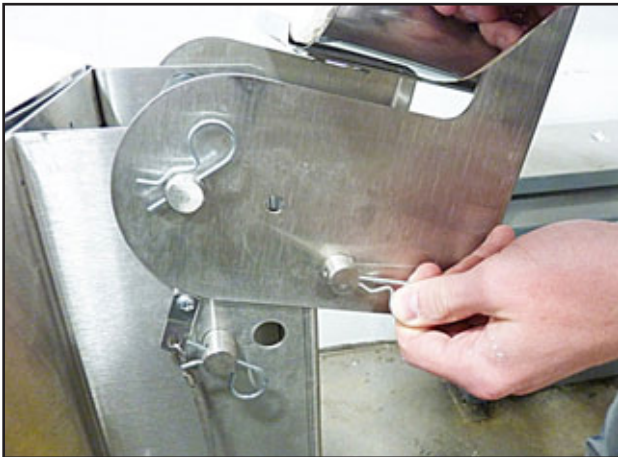

3) Slide out the top-most hinge bar, set this aside with the cotter pin that you already removed.

Removing the top-most bar:



4) Carefully close the lid of the kiln. **NOTE:** By removing the top-most hinge bar the springs have been disengaged and the full weight of the lid will now exert its downward force. Use caution when performing this step.

The closed lid without the top-most hinge bar:



5) Remove one of the cotter pins from the middle hinge bar. This is the one that runs through the springs.

Removing a cotter pin from the middle bar:



6) Grasp both of the springs with one hand and carefully slide out the middle hinge bar. The springs will be freed once the bar has been removed. Set this all aside, along with the cotter pin that you already removed.

ASSEMBLY INSTRUCTIONS FOR L&L EASY-FIRE KILNS

Removing the middle bar and springs:



7) Your lid is now free of the kiln rings and can carefully be removed.

Lifting the lid off of the kiln body:



NOTE ABOUT e18S and e18T HINGES: These standard hinges are simple and are shown on page 18.

MOVING THE KILN WITHOUT DISASSEMBLING IT

SEE THE CAUTION NOTE ON PAGE 1 OF THESE INSTRUCTIONS. THIS TAKES TWO OR THREE STRONG PEOPLE TO DO.

Moving an e18S, e18T, e23T or e28T:

1) Remove the lid because this is easy and removes much of the weight. 2) Prepare the stand and place the floor slab on the stand. 3) Pick the the kiln up by the chest handles on the bottom kiln section and place the three connected sections on the floor slab.

Moving an e23S or e28S:

1) Remove the lid because this is easy and removes much of the weight. 2) Prepare the stand. 3) Pick up the kiln by the front chest handle attached to the kiln floor and by the hinge. 4) Place the entire unit on the prepared kiln stand.

CAUTION: It is important to lift the two-section kilns up by the handle on the floor slab because the hinge is attached to the floor slab in the back of the kiln. You will damage the floor slab if you do not follow this procedure.

Go to "LOCATING THE KILN" on page 13.

ASSEMBLY INSTRUCTIONS FOR L&L EASY-FIRE KILNS

REMOVING THE HINGE

1) Loosen the screws of the large hinge piece that holds the three rings together (or the two rings and bottom).

WE RECOMMEND NOT REMOVING SCREWS. The teardrop holes will allow you to remove the hinge piece without taking the screws out. If you take the screws out it increases the chance of stripping a screw. Even though there are plenty of screws to take the load it is best to avoid stripping them.

2) Gently pull the ring hinge piece up and away from the kiln.

Pulling the hinge piece up and away from the kiln. It should slide up easily. If not check all the screws because it only takes one screw that is not loose enough to prevent the hinge piece from sliding up:



REMOVING THE CONTROL PANEL AND ELEMENT COVER AS ONE ASSEMBLY

You have two choices. You can remove the Control Box and Element Cover Box as ONE assembly or you can first remove the Control Box from the Element Cover Box and then remove the Element Cover Box. The easiest method, in our opinion, is to remove the whole assembly. However, both methods are given.

1) Remove the two screws, that hold the outer portion of the control panel to the element terminal box, set these aside.

Removing the two screws that hold the control box closed:



2) Hinge the DynaTrol portion of the control panel down exposing the wire connection terminals.

The control box hinged down:



3) Remove the wires numbered 1 through 6 from the left side of the Power Terminal Strip and the right side of Thermocouple Terminal Strip.

ASSEMBLY INSTRUCTIONS FOR L&L EASY-FIRE KILNS

Wires shown disconnected:

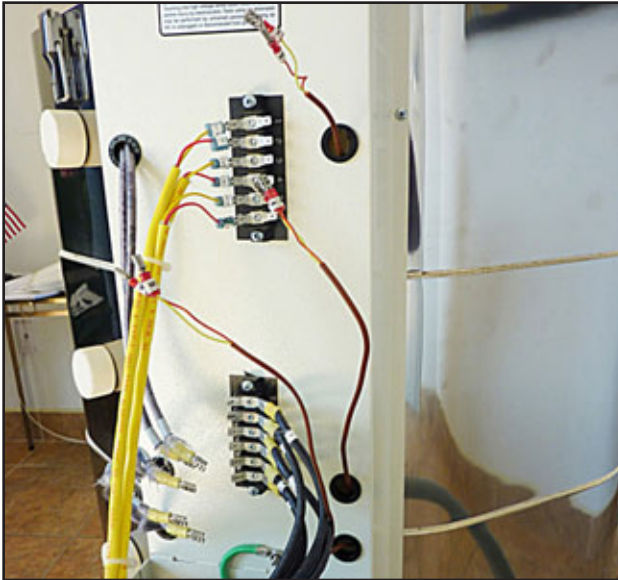

4) Remove the two screws that hold the Element Cover Box to the kiln, these are on the right side of the Cover Box, set these aside.

Removing the two screws that hold the element cover box closed:



5) Swing the whole assembly away from the kiln body, to the left, carefully feeding the element and thermocouple wires through their respective holes

Swinging the whole assembly to the left and removing the wires:



6) Gently lift the whole assembly off of the hinges on the left of the Element Cover Box.

Lifting the whole assembly off of the kiln body:



ASSEMBLY INSTRUCTIONS FOR L&L EASY-FIRE KILNS

7) Now skip to the the section called “LOCATING THE KILN”.

REMOVING THE CONTROL BOX

This is method number two.

1) Remove the two screws, that hold the outer portion of the control panel to the element terminal box.

Removing the two screws that hold the control box closed:



2) Hinge the DynaTrol portion of the control panel down exposing the wire connection terminals.

The control box hinged down:



3) Remove the wires numbered 1 through 6 from both sides of the Thermocouple Terminal Strip.

Disconnecting the thermocouple wires:

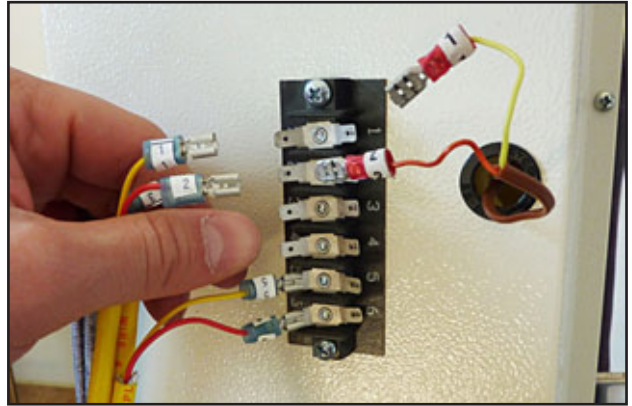

4) Remove wires numbers 1 through 6 from both sides of the Power Terminal Strip.

Disconnecting the power wires:



5) Remove the green ground that connects the front panel to the rear panel.

Removing the ground wire:



ASSEMBLY INSTRUCTIONS FOR L&L EASY-FIRE KILNS

6) Tilt the control panel halfway back to its original position and gently pull the panel from the element box and set aside. It will take a combination of pulling slightly up and slightly out to disengage the control panel from the element terminal box.

Removing the control box:



REMOVING ELEMENT COVER BOX

If you prefer you can remove the box using the method shown on page 7 instead.

1) Remove the two screws that hold the Element Cover Box to the kiln, these are on the right side of the Cover Box, set these aside.

Removing the two screws that hold the element cover box closed:



2) Swing the Element Cover Box away from the kiln body, to the left, carefully feeding the element and thermocouple wires through their respective holes

Swinging the element cover Box to the left and removing the wires

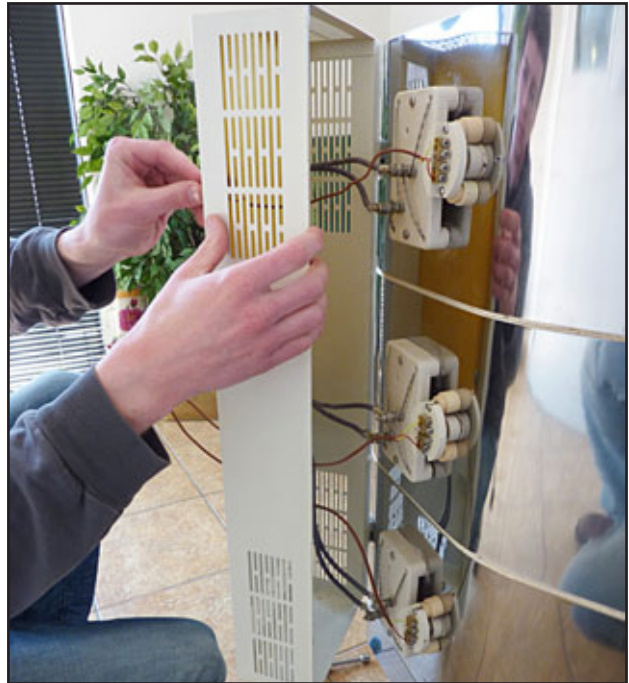

3) Gently lift the element cover box up and remove from the kiln sections.

Removing the element cover box from the kiln:



4) You are now ready to set up the kiln.

ASSEMBLY INSTRUCTIONS FOR L&L EASY-FIRE KILNS

LOCATING THE KILN

1) Place the stand on the floor in the desired location. This should be set so that the outside stainless steel surface of the kiln will be at least 12" to 18" from any combustible wall. Floor must be nonflammable.

Information concerning clearances, ventilation and electrical requirements is detailed in the INSTALLATION Section. Read now if you are uncertain about any of these issues. **DON'T PROCEED UNTIL YOU ARE COMFORTABLE WITH THE LOCATION THAT YOU SELECT.** You don't want to do this job twice.

- 2) Place bottom floor section of kiln on the stand, making certain it is centered properly.
- 3) Note that the kiln bottom is packed on top of the kiln so it is easily removed first without moving the kiln.

SETTING UP THE KILN

1) Place the stand in your desired location making sure to face the flexible duck work toward the wall that the kiln will be vented through.

The stand in position on the floor:

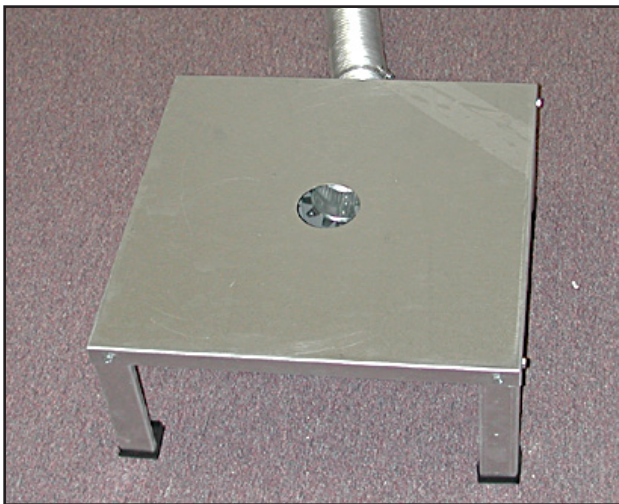

- 2) You're now going to build the kiln from the bottom up.
- 3) Place the bottom of the kiln on the kiln stand, make sure the holes for the vent, if ordered, line up with the large 3" hole on the kiln stand. Center the bottom brick

on the stand. It is not critical how the polygonal corners are oriented to the square stand.

The kiln base positioned on the stand:

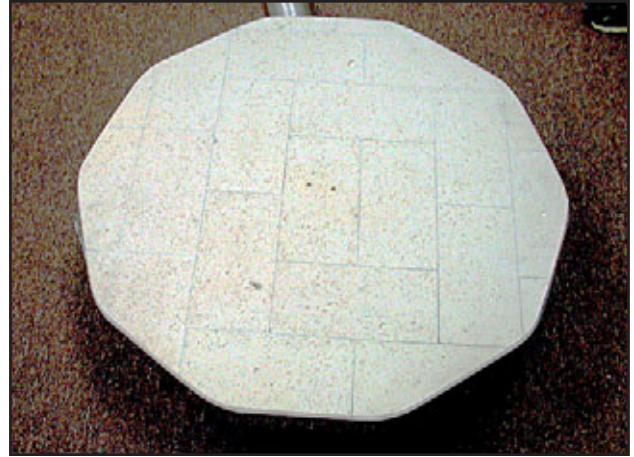

4) **LEVEL THE KILN NOW!** Do this before proceeding because at this point it is easy to put a level on the flat bottom. Use metal shims under the legs to accomplish the leveling. We suggest using a carpenter's level for this job. Make sure that the base will not wobble.

WHY IS LEVELING SO IMPORTANT?

If the stand and the bottom are not level your kiln shelves will not be level and loading will be difficult. Kiln shelves loaded with ceramic ware are like a house of cards to begin with - don't make it any harder!

Also - an uneven floor will quickly become a cracked floor. There should be equal support under each leg of the stand so the floor does not rock back and forth.

Be patient about doing this right as you are assembling the kiln. Once you have put the kiln sections on the bottom of the kiln you will not feel like taking it off - so it is important to have this base be level to start with.

5) Place the kiln section with the #5 & #6 on the thermocouple wire on top of the kiln stand (this will not exist for an e23S or e28S so skip to the next step if you have one of those kilns).

ASSEMBLY INSTRUCTIONS FOR L&L EASY-FIRE KILNS

Positioning the bottom ring on the base:



6) Place the kiln section with the #4 & #3 on the thermocouple lead wire on next.

Positioning the middle ring:



7) Place the kiln section with the #1 & #2 on the TC wire on the top ring of the stack.

Positioning the top ring:



8) You are now ready to reattach the hinge.

SETTING UP THE HINGE

1) Notice that on the back of the kiln that the mounting screws for the hinge line up. There should be 20 total, 10 on each side.

The mounting screws lined up:



2) Reattach the Kiln Bracket to the back of the kiln by dropping it onto the screws on the kiln sections. If the screws on the kiln don't perfectly line up with the holes in the bracket, gently maneuver the bracket until you have all the screw heads into the keyhole slots. Let the bracket drop so that the top of the slots rest against the screws. **Do not tighten the screws at this time.**

The slots resting on the loose screws:

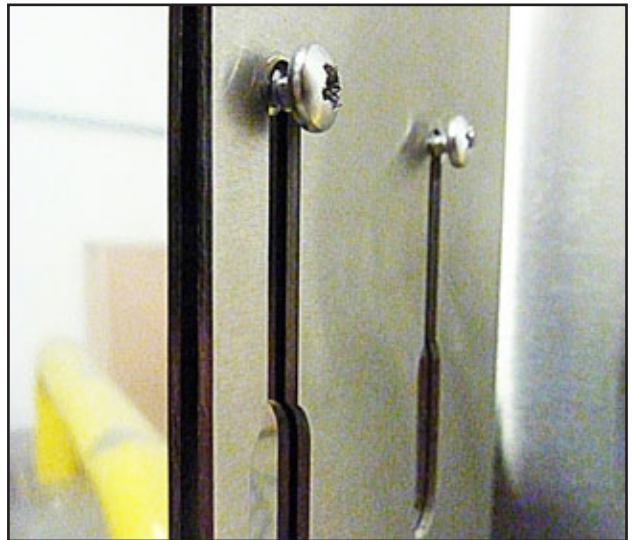

3) Set the Lid onto the top ring of the kiln, making sure the lid flange fits around the outside of the kiln bracket.

ASSEMBLY INSTRUCTIONS FOR L&L EASY-FIRE KILNS

The Lid as ready for hinge installation:

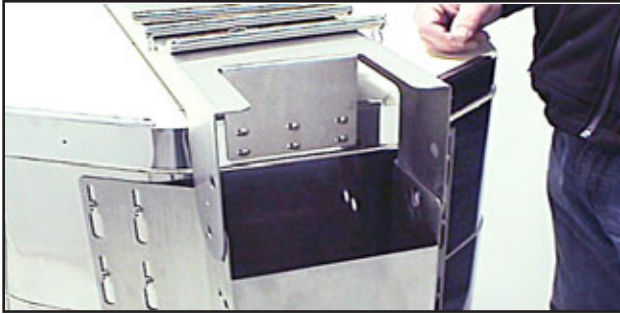

4) Slide one of the 3 metal rods through the middle set of holes. You will notice that the holes on the kiln bracket are elongated circles.

Sliding in the middle rod:



5) Adjust the height of the bracket by sliding it upwards until the metal rod you inserted in the middle set of holes rests on the bottom ends of the elongated circular holes.

Positioning the hinge bracket:

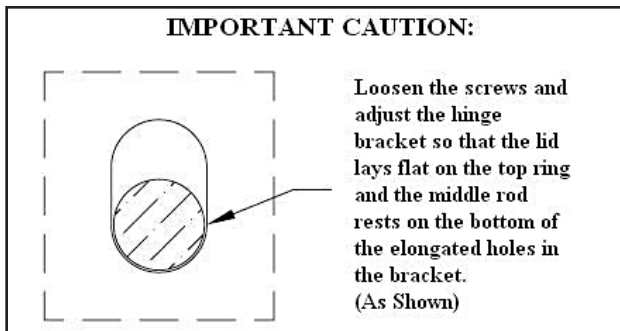

6) Tighten each of the 20 screws to secure the Hinge Bracket in this position.

CAUTION: It is critical that the hinge bar sits in the bottom of the slot. This is to allow the lid to rise and lower slightly as the kiln heats and expands with out putting stress on the lids connection points and potentially damaging the lid.

7) Remove the middle metal rod. Hold the two hinge springs on the inside of the hinge bracket chamber and slip the rod back through the holes and through the center of the springs. Ensure that the outer spring ends are sitting on either end of the back of the bracket.

Installing the middle rod and springs:

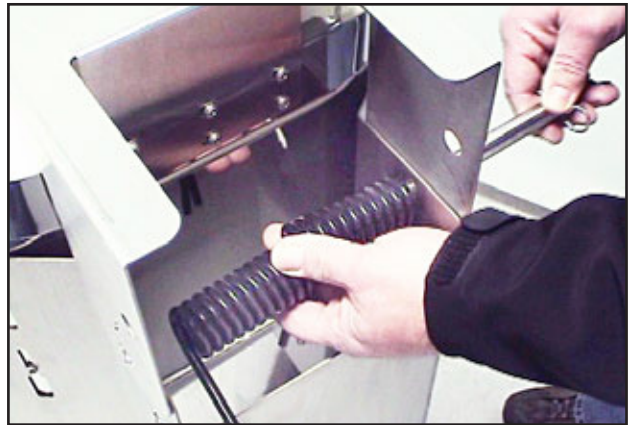

8.a) If you left the bottom metal rod in the kiln bracket ensure that the inner spring ends rest against the inside face of the rod, closest to the kiln body.

8.b) Take the second metal rod and run it through the bottom set of holes on the kiln bracket. Make sure that the inner spring ends stay towards the kiln. This will create tension when the spring is loaded.

Installing the bottom-most rod:



ASSEMBLY INSTRUCTIONS FOR L&L EASY-FIRE KILNS

9.) Once the two metal rods are set in place, set the Cotter Pins in place at each end of the rods.

Setting the cotter pins:

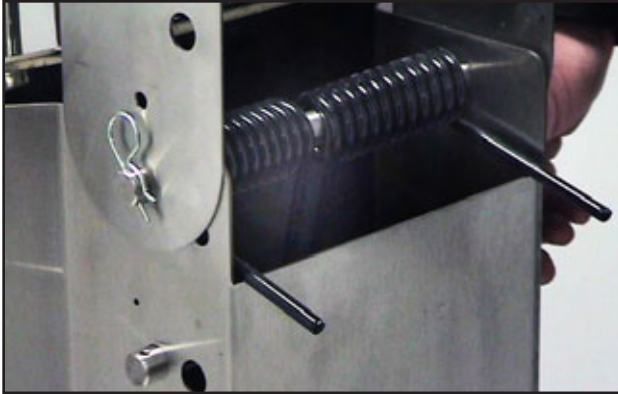

10) Carefully raise the lid until the top set of holes passes below the spring ends that are resting on the back of the bracket. Once this occurs, slide the third and final metal rod through the holes on the lid flange.

Installing the top-most rod:



11) Once the metal rod is set in place, set the Cotter Pins in place at each end of the rod.

The properly Installed spring hinge open:



12) You will see that when the lid is lowered, this metal rod will catch the spring ends and the weight of the lid

will be reduced as the lid is now properly installed.

The properly Installed spring hinge closed:



OPTIONS:

There is another set of holes on the Kiln Bracket if you find that the tension provided from the original configuration is insufficient. Simply try the second set of holes in the same manner as in step 5.

WARNING:

Only use one of the two sets of hole configurations. Never use both.

ASSEMBLY INSTRUCTIONS FOR L&L EASY-FIRE KILNS

ADJUSTING THE SMALL NON-SPRING HINGE

- 1) The non-spring hinge is a very simple system that employs a hinge bar, brackets for the top ring and lid, and support chains between the lid and top ring.
- 2) To take apart the hinge simply pull out one of the cotter pins, remove the hinge bar, and unscrew the screws that hold the support chains in place.

Closed lid with a standard hinge:



- 3) If the brackets are ever adjusted you must ensure that the hinge rod rests on the bottom ends of the elongated circular holes. Move the ring bracket up or down to achieve this result.

Positioning the hinge bracket:



CAUTION: A Screw Hook is included with the non-spring hinge. This should be secured in a stationary position behind the kiln and be used in conjunction with the chain on the lid handle to prevent the lid from falling when open.

ASSEMBLY INSTRUCTIONS FOR L&L EASY-FIRE KILNS

REASSEMBLING THE CONTROL PANEL

1) Take the Control Box and Element Cover Box Assembly and position the hinges that are attached to the left of the Element Cover Box above the hinge pieces on the kiln body, to the left of the Element Connection Boards. Lower it into place.

Reattaching the element cover box:



2) Leave the assembly swung out away from the kiln body. Push the element and thermocouple wires through their respective holes in the Element Cover Box.

Feeding the wires back through the holes:

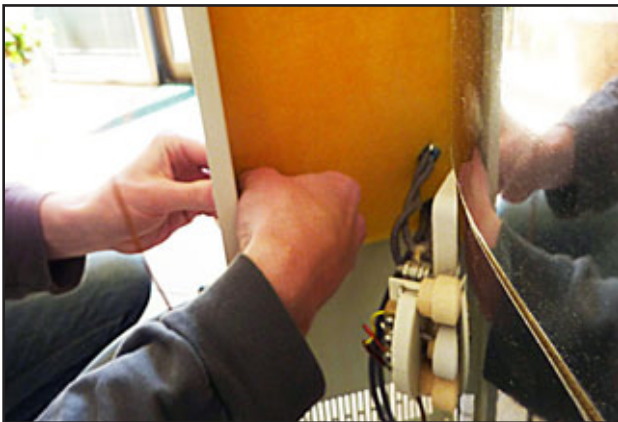

3) Push the Element Cover Box up against the kiln. Insert and tighten the screws back into the right side of the Cover Box.

Tightening the element cover box screws:



4) Attach all the wires to their proper place on the terminal boards. They are numbered for convenience.

Wires properly reinstalled:

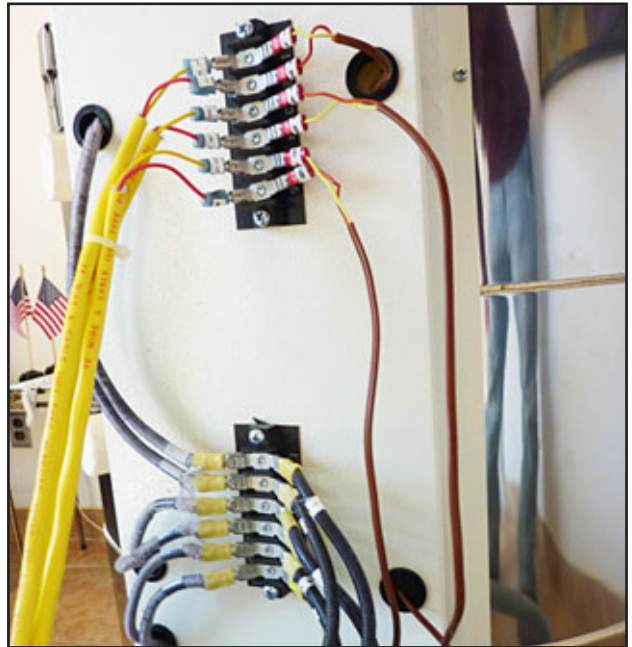

ASSEMBLY INSTRUCTIONS FOR L&L EASY-FIRE KILNS

5) Close the Control box and screw in the two screws that hold it in place at the top of the Element Cover Box.

Tightening the control box screws:



If you removed the panel separate from the element cover box

1) Take the Element Cover Box Assembly and position the hinges that are attached to the left of the Element Cover Box above the hinge pieces on the kiln body, to the left of the Element Connection Boards. Lower it into place.

Reattaching the element cover box:



2) Leave the assembly swung out away from the kiln body. Push the element and thermocouple wires through their respective holes in the Element Cover Box.

Feeding the wires back through the holes:

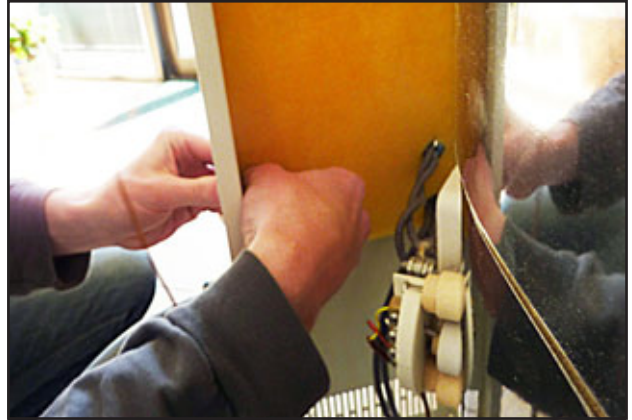

3) Push the Element Cover Box up against the kiln. Insert and tighten the screws back into the right side of the Cover Box.

Tightening the element cover box screws:



5) You are now ready to reattach the hinge portion of the dynatrol panel.

ASSEMBLY INSTRUCTIONS FOR L&L EASY-FIRE KILNS

REATTACHING CONTROL BOX

1) Place the tabs on the control panel box back in to the appropriate slots on the element cover box.



2) Reattach the ground wire to the ground lug from the control box to the element cover box.

Reattaching the ground wire:



CAUTION: Lock washers must be used on both ends of the ground wire to ensure a good electrical connection; otherwise shock may not be prevented in the case of a short circuit.

3) Reattach all power wires to the appropriate numbered terminals.

Power wires properly reinstalled:

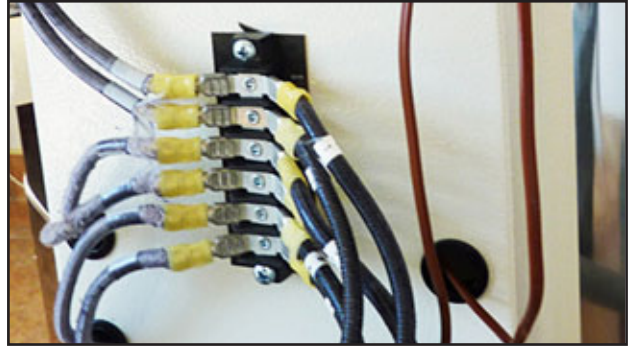

4) Reattach the thermocouple wires to the appropriate numbered terminals making sure yellow goes with yellow and red goes to red. Make sure to push the slip on terminals all the way onto the tabs on the connection terminals.

Thermocouples wires properly reinstalled:

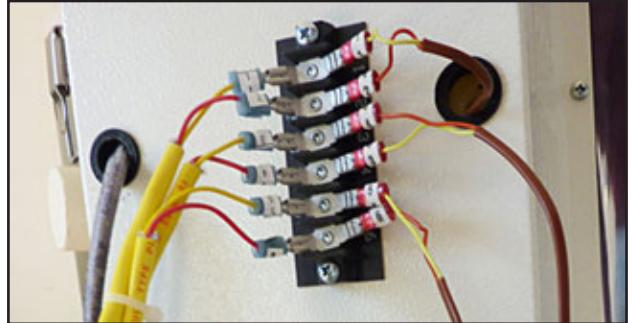

5) Raise the panel and replace the two screws at the top and tighten making sure to keep the thermocouple lead wires and the power connect wires from getting pinched in the panel.

Tightening the control box screws:



6) Your kiln is now fully assembled and ready to operate.

DURA-FIRE INSTRUCTION MANUAL



L&L Kiln's patented
hard ceramic
element holders
protect your kiln.

INSTALLATION & PREORDER INFORMATION FOR L&L KILNS

TABLE OF CONTENTS

KILN CAUTIONS	1
DATED INFORMATION	1
SAFETY APPROVALS & LISTINGS	1
LOCAL CODES	1
UL LISTING	1
NATIONAL ELECTRICAL CODE	2
NATIONAL FIRE PROTECTION ASSOCIATION	2
UNIFORM MECHANICAL CODE	2
ELECTRICAL INSTALLATION	2
VOLTAGE AND POWER	2
WHAT VOLTAGE DO YOU REALLY HAVE?	2
WHAT PHASE DO YOU HAVE?	2
USE A FUSED DISCONNECT	3
USE PROPER FUSES	3
LOCATE KILN WITHIN 50 FEET OF BREAKER	3
USE PROPER GROUNDING	3
USE COPPER WIRE FOR HOOK UP	3
USE THE PROPER WIRE GAUGE	4
INSTALLING A PLUG RECEPTACLE	4
PROTECT POWER CORD FROM KILN CASE	4
DIRECT HOOK-UP KILNS	4
DO NOT USE EXTENSION CORDS	4
OFF-PEAK ELECTRICAL USAGE	4
WHERE TO GET MORE INFORMATION	4
CLEARANCES & SURFACES	4
DOORWAY CLEARANCES FOR MOVING	4
CLEARANCES IN KILN ROOM	5
WALL MATERIALS	5
FLOORS	5
AIR CIRCULATION UNDER THE KILN	5
OTHER CLEARANCES	5
KILN ROOM ENVIRONMENT	5
KEEP KILN DRY & IN PROTECTED SPACE	5
AMBIENT TEMPERATURE	6
FIRE EXTINGUISHER	6
FIRE SPRINKLERS	6
VENTILATION REQUIREMENTS	6
VENTILATION IS ESSENTIAL	6
VENTILATION FOR THE KILN	6
CARBON MONOXIDE MONITORING	7
VENTING CODES	7
HVAC AND AIR CONDITIONING ISSUES	7
OTHER ACCESSORIES NEEDED	7
SHELVES AND POSTS	7
GLOVES AND GLASSES	7
CONES	8
SELECTING AN ELECTRICAL CONTRACTOR	8
When considering an electrical contractor:	8
FINAL CHECKLIST	8

INSTALLATION & PRE-ORDER CHECKLIST FOR NEW KILNS

Please review and fill out the checklist at the end of this form, to avoid unpleasant surprises after your new kiln is installed. Make sure of your electricity and your physical environment, then you can place your kiln order with complete ease of mind! This checklist should be used for anyone specifying a kiln, including architects. Kilns are appliances with a few special characteristics, such as high power draw, ventilation requirements and unusually hot surfaces. A few hours work up front can save lot of trouble and expense later. There is a more specific installation guide for EASY-FIRE kilns (hotkilns.com/easy-fire-install.pdf).

KILN CAUTIONS

See *cautions.pdf* in the CAUTIONS section for a complete list of cautions associated with electric kilns.

DATED INFORMATION

The information in these Installation Instructions is believed to be correct to the best of our knowledge at the time of publication (see the date at the bottom). You can download the most recent update from our web site at www.hotkilns.com/install.pdf at any time.

SAFETY APPROVALS & LISTINGS

LOCAL CODES

Local fire and safety codes superceed information that is provided in these Installation instructions or in our Caution instructions.

UL LISTING

You may want to check with your local building inspector if you are uncertain what codes may apply to the installation of a kiln. This does vary from place to place. It may also be a requirement of your insurance policy. In any case, you will never go wrong in having a UL499 listing label on any appliance. Most building inspectors will accept this as adequate evidence of proper adherence to national safety standards.

INSTALLATION & PREORDER INFORMATION FOR L&L KILNS

All Jupiter, Easy-Fire, and DaVinci (except the Model TB644754) are listed to UL 499 Standards for both the US and Canada by MET (An NRTL - Nationally Recognized Testing Laboratory). The Vent-Sure vent is listed in both the US and Canada for use with L&L listed kilns. UL 499, CSA C22.2, No. 122, CSA C22. Listing No E112742.

Easy-Load and Renaissance kilns are listed to UL499 Standards in the US only. UL 499. Listing No E112742.

The Doll/Test Kiln, Liberty-Belle, Chamelion, and GS1714 are not listed.

NATIONAL ELECTRICAL CODE

Be sure your electrician follows the National Electric Code and any other local requirements when hooking up the kiln. One of the requirements of this code that bears particular mentioning is the fact that you must fuse your kiln appliance for 125% of its rated maximum amperage draw. This explains why you see fusing requirements in our electrical specifications that are in excess of the amperage draw of the kiln. The fuse for the kiln is either a circuit breaker or a fused disconnect switch.

NATIONAL FIRE PROTECTION ASSOCIATION

To the best of our knowledge, the NFPA has nothing specific about the installation of kilns. The NFPA 86 goes into considerable detail about industrial furnaces and ovens but generally with respect to internal processes and gas-fired equipment. There is one section in the NFPA 86 (Section 2-1.5 concerning Floors and Clearances) that might be construed as applicable to kilns. It requires that temperatures at combustible ceilings and floors be kept below 160°F (71°C). In general the NFPA recommends installing furnaces on noncombustible surfaces and has specific requirements if this is not possible. You can order a copy of this by going to their web site at www.nfpa.org or by calling 617-984-7249.

UNIFORM MECHANICAL CODE

Section 920.0 specifically discusses Small Ceramic Kilns and their installation. Some of the clearance information from this is given further on. However, it is best to refer to this book for complete details. This is

published by the International Association of Plumbing and Mechanical Officials and can be purchased online at www.iapmo.org/iapmo/publications.html or by calling 800 85-IAPMO (800-854-2766) / Fax (909) 598-4720.

ELECTRICAL INSTALLATION

VOLTAGE AND POWER

The first item on the checklist is electricity. Make sure that you know your voltage and phase before placing an order for a new kiln! We can supply kilns with either 208, 220, 240, 380 or 480 volts, single or three phase - all depending on your power characteristics. If you do not know for sure what your power is, have an electrician check it for you.

WHAT VOLTAGE DO YOU REALLY HAVE?

L&L makes different heating elements for 208 volts, 220 volts, 240 volts, 380 volts and 480 volts. It is not easy or cheap to change the kiln from one voltage to another once it is installed. A kiln supplied from the factory for 240 volts will have 25% less power if operated on 208 volts - and this will result in slow firing, and perhaps underfiring if not corrected. Many schools and factories in the United States have 208 volts whereas almost all homes in the United States have 240 volts. (Nominal 240 volts can actually be as low as 220 volts). Some people think they have 220 volt power because many appliances are designed to run off either voltage and are labeled 220. Even if you only measure 220 volts (if you are in the United States), this is probably due to an under-voltage condition. You wouldn't normally want to have 220 volt elements because if the power does go up from the measured 220 volts then the kiln would be over-powered and it could draw too many amps for the circuit. Note that utility companies typically allow for a 10% voltage fluctuation. The most common voltage outside the United States is either 380/3 phase or 220/1 phase.

WHAT PHASE DO YOU HAVE?

Also check for proper phase. Most residential buildings have single phase power which consists of 2 hot wires, a neutral and a ground wire. Many com-

INSTALLATION & PREORDER INFORMATION FOR L&L KILNS

mercial areas have 3 phase power available which consists of 3 hot wires, a neutral and a ground.

You also need to make sure that your home or building has enough ampere capacity to carry the electrical load of your new kiln. Each kiln model is listed with voltage, phase, KW, and amperes. Using these electrical specifications, check the listed amperes and check that your building power supply is adequate. A trickier thing to know is the real capacity of your power grid. We have sometimes seen situations (rarely, but very annoying when it happens) where the demand put on a specific power grid ends up lowering the voltage of the entire grid. For instance you might go in and test the lines and find you have 238 volts and then, when a large kiln is firing, have only 218 volts. Again, if you do not know for sure whether your power supply can handle this new load, have an electrician check it for you. NOTE: like anything else there are good and bad electricians. Chose one with care by getting a few references.

USE A FUSED DISCONNECT

We recommend having a separate fused disconnect box with a lockout provision mounted near the kiln, even if you also have a separate circuit breaker for your kiln. This way you can easily turn off power to the kiln and prevent unauthorized people from turning it on. We recommend this even for kilns with plugs because it makes it so much easier to disconnect all power to the kiln when not using it. Note that if you unplug a kiln frequently the spring tension in the outlet can weaken over time. A Fused Disconnect switch allows you to positively turn off power to the kiln without unplugging it.

USE PROPER FUSES

Fuses and circuit breakers are overcurrent devices designed to protect electrical circuit components. If a circuit develops too many amperes, they are designed to open, interrupting the flow of current in the circuit. Fuses self-destruct when they sense an overload in the circuit. Circuit breakers are commonly used in new construction; they trip (turn off power) when they sense an overload, and can be reset (turned back on) when the circuit is returned to normal.

Circuit breakers are more convenient because of this

feature. However, they can cause nuisance tripping and ruin kiln firings when they trip part way through a firing. This is because most circuit breakers are activated thermally; if the circuit breaker temperature rises above a preset level, a bimetallic element inside the circuit breaker opens, and the power is turned off. This works well most of the time; however, over time the bimetallic element becomes weaker because resistance heating circuits are at their rated load longer than other types of electrical loads such as motors. Eventually the circuit breaker becomes too weak to hold itself closed over a long enough time to finish a kiln firing, unless the circuit is drastically oversized to compensate for this gradual aging process.

For protecting kiln circuits, 'one-time' general-purpose type fuses should be used. These are inexpensive, have no appreciable time delay, and are available in a large variety of sizes. They are also widely and easily available, and are made by several large fuse manufacturers.

LOCATE KILN WITHIN 50 FEET OF BREAKER

Try to locate the kiln within 50 feet of your breaker box. For longer runs you will probably have to increase the size of the hook up wire that we recommend in our literature. In any case, be sure to have a licensed electrician who knows the National Electrical Code hook up the kiln and size the hook up wire.

USE PROPER GROUNDING

Make sure your electrician properly grounds the kiln and then tests for proper grounding after the installation.

USE COPPER WIRE FOR HOOK UP

Don't use aluminum wire. It is cheaper to use aluminum wire and you may be tempted to do so. Many electricians will tell you that, with the new types of connectors, it is OK. However, it is of particular importance with kilns not to use aluminum wire for the hook ups. The specific reason particular to kilns is that the wire tends to get hotter near the kiln than it might going into some other types of appliance. Also, being a resistive load, there is constant heat being generated by the conductors for quite a few hours. When aluminum wire gets hot it accelerates oxidation. Aluminum oxide is a resistor; copper oxide is not as much. If the connection at the

INSTALLATION & PREORDER INFORMATION FOR L&L KILNS

terminal board gets oxidized it will really heat up - to the point where it could cause a fire. Note: Depending on local codes it may be OK to use aluminum wire to your subpanel - as long as that wire is not exceeding its temperature rating while kiln is firing on full power for an extended period of time.

USE THE PROPER WIRE GAUGE

Hook-up wire sizes are provided for many of our kilns in the electrical specifications. However, this can vary depending on ambient temperature conditions and length of wire run.

Running power for your kiln over a long distance will result in a drop in voltage. This chart gives some approximate idea of this:

<u>7 volts per 100 feet with 10 awg wire</u>
<u>21 volts per 300 feet with 10 awg wire</u>
<u>6 volts per 100 feet with 6 awg wire</u>
<u>18 volts per 300 feet with 6 awg wire</u>
<u>3 volts per 100 feet with 1 awg wire</u>
<u>9 volts per 300 feet with 1 awg wire</u>

These estimates are dependent on the kiln operating at 50% to 100% of its capacity, with the temperature of the wire no more than 167°F.

INSTALLING A PLUG RECEPTACLE

If you a plug in your kiln install the receptical in such a way that the cord hangs down (not up). Do not place the outlet so close to floor that the kiln cord bends up at a sharp angle. The principle to pay attention to is make sure the plug seats securely in the receptical. Otherwise it could overheat and corrode which could cause an electrical fire.

PROTECT POWER CORD FROM KILN CASE

Rout Power Cord away from kiln in such a way that it can not touch the hot case of the kiln. Secure it so it can not move. If cord touches the hot case it could melt and cause a short circuit and/or fire.

DIRECT HOOK-UP KILNS

If you are getting a "direct hook up" kiln (all kiln sizes above 48 amps and most 3 phase kilns) be sure to have the kiln wired so that the final connection to the

box is flexible (for instance, by using liquid tight flexible conduit). Ideally, the kiln should be wired to a fused disconnect box located within 15 feet of the kiln. This way, if you ever need to remove the control panel for factory service you can turn off power to the kiln, unhook the 3 or 4 wires from the control box terminal block, and remove the panel.

Use a supply wire size large enough for the whole circuit amperage - not just the amperage that the kiln is pulling under load.

All L&L power cords are rated for 105°C. Anything less than this can cause a malfunction and possible fire where the power leads connect to the control box.

It is OK, and will not void the warranty, to remove the plug that comes with the kiln and direct wire the kiln. However, the connection wires must be rated for a minimum of 105°C.

Protect the wire with flexible or rigid conduit.

DO NOT USE EXTENSION CORDS

Extension cords are only OK to use for the 120 volt vent system. Do NOT use an high power extension cord for the kiln.

OFF-PEAK ELECTRICAL USAGE

Some utilities offer special rates for running energy intensive appliances (like kilns) during off-peak hours. Check with local utility. This would require a special time-of-use electrical meter.

WHERE TO GET MORE INFORMATION

See hotkilns.com/volts.pdf for a complete description of electrical theory, fusing, hook-up wire sizes, etc. as they apply to kilns. See the section on POWER SUPPLY in troubleshoot-general.pdf in the TROUBLESHOOTING section of your manual.

CLEARANCES & SURFACES

DOORWAY CLEARANCES FOR MOVING

All Jupiter, Easy-Fire, Liberty-Belle and DaVinci kilns can be disassembled and carried in sections through any standard 30" or larger doorway. Doll kilns and the GS1714 will fit through a 30" door. The

INSTALLATION & PREORDER INFORMATION FOR L&L KILNS

Easy-Load front loading kilns vary in door width requirements (see the brochure for specifications).

CLEARANCES IN KILN ROOM

Make certain floor is not flammable and install no closer than 12" to any wall. (18" is strongly recommended). Note that, when we did our testing for UL, temperatures were measured 12" from the walls of the kiln and found to be safe from a flammability standpoint. The Uniform Mechanical Code 2000 Edition states that "the sides and tops of kilns shall be located a minimum of eighteen (18) inches (457 mm) from any noncombustible wall surface and three (3) feet (914 mm) from any combustible wall surface." The National Fire Protection Agency states that temperatures at combustible ceilings and floors be kept below 160°F (71°) near industrial furnaces (which are like kilns).

WALL MATERIALS

Check with local building codes for recommended non-combustible wall materials for walls that are adjacent to the kiln. Cement board, cinderblocks, and masonry tile are possible choices.

FLOORS

The Uniform Mechanical Code 2000 Edition states that "kilns shall be installed on noncombustible flooring consisting of at least two (2) inches (51 mm) of solid masonry or concrete extending at least twelve (12) inches (305 mm) beyond the base or supporting members of the kiln." Recommended floor surfaces are cement, ceramic tile, stone, slate, cinder blocks or brick. Do not install on a wood floor or on carpet. Vinyl flooring may be combustible. Protect linoleum flooring from discoloration with a noncombustible covering. **BE VERY CAREFUL ABOUT IMPLEMENTING THESE SUGGESTIONS.** Remember that the kiln is putting out heat over a long period of time and that this could very well start a fire under certain conditions. Also, if an overfiring occurs, materials like glass and glazes can be super-heated and electrically conductive and they can melt right through the kiln floor. If there is a combustible floor, this could cause a fire. Also keep in mind the continued heat of the kiln can dry out combustible surfaces over time and reduce their flash point. The

NFPA 86 (Section 2-1.5 concerning Floors and Clearances) that might be construed as applicable to kilns requires that temperatures at combustible ceilings and floors be kept below 160°F (71°C). In general the NFPA recommends installing furnaces on noncombustible surfaces and has specific requirements if this is not possible.

AIR CIRCULATION UNDER THE KILN

It is CRITICAL to have air circulation under the kiln. This prevents heat from being directly conducted to the floor surface. If the floor (or subfloor) is combustible a fire could result. Even if the floor is non-combustible (like solid cement) you would create a very inefficient system by placing the kiln directly on the floor. The supplied stands (which typically raise the kiln 8" from the floor) have been tested to ensure a minimum of heat transfer. It is important to use the kiln with its supplied stand. Any substitutes must be carefully tested by the user.

OTHER CLEARANCES

Make sure there is adequate clearance in the room for opening the kiln lid, and for periodic maintenance such as opening the element connection boxes, opening the control panel, thermocouple replacement, etc. 18" to 24" clearance around the outside wall of the kiln is usually sufficient.

KILN ROOM ENVIRONMENT

KEEP KILN DRY & IN PROTECTED SPACE

The kiln must be kept dry so it must be kept in an enclosed room away from inclement weather. The electrical circuits must not get wet. If for some reason they do get wet they must be thoroughly dried before operating the kiln. Kilns can corrode fairly rapidly if kept in rooms that have no climate control. The constant heating and cooling in an unheated shed, for instance, can cause dew to form on the cold metal and this can cause corrosion. Also exposure to salt air will accelerate corrosion dramatically. Also failure to adequately vent the kiln will allow the corrosive fumes that are generated in the firing process to corrode the metal, the wiring and even the firebrick. This sort of damage is specifically excluded from warranty

INSTALLATION & PREORDER INFORMATION FOR L&L KILNS

coverage.

AMBIENT TEMPERATURE

The kiln should operate in an environment that is between 0°F and 100°F. Some people keep their kilns in unheated garages or sheds. This is OK as long as the room is dry. The DynaTrol has a specification that says it can work from 32°F to 125°F. These limits can be exceeded on the low end. (The control won't deal with negative numbers so if you go below 32°F you must have the control set up for Deg F - not Deg C) On the low end it has more to do with the accuracy of the control. As the kiln reaches the point where accuracy is an issue then the control will most likely be warmed sufficiently by the kiln to insure that it is operating within specification. However, on the high end, the electronics could degrade if operated for long periods above 125°F.

FIRE EXTINGUISHER

We would recommend that an adequate fire extinguisher be kept near the kiln and checked on a regular basis. You may want to check with your local fire authorities to see if there are any specific requirements they have such as sprinkler systems, automatic foam extinguishers, etc. Use a fire extinguisher that is rated for electrical fires. We recommend an ABC fire extinguisher.

FIRE SPRINKLERS

If you have a fire sprinkler system position the sprinkler heads in the ceiling away from the kiln(s). The rising heat from the kiln, under normal operating conditions, could set off the sprinklers which will cause water damage. Consider using a higher temperature sprinkler head or one that is set off by smoke. Also consider using the canopy type vent system in this type of environment which will lower the temperature above the kiln. Test the installation under the worse conditions to be sure that you are not creating a hazard.

VENTILATION REQUIREMENTS

VENTILATION IS ESSENTIAL

Kilns generate harmful fumes when firing ceramics. Fumes can include carbon monoxide, formaldehyde,

sulfur dioxide, heavy metal vapors, and fluorides (all of which can be very toxic). Install kiln in well-ventilated area. Never operate in an enclosed space such as a closet unless you have good ventilation. Aside from issues of ventilating the fumes from the firing, the heat build up in an enclosed room could present a significant fire hazard. Severe corrosion can be caused by kiln fumes, salt air or other environmental conditions. Good venting can minimize these problems. **Ventilation must be to the outside.** We recommend room ventilation of at least 10-25 times the cubic feet of the kiln per hour. For example, if a kiln has 10 cubic feet then 250 cubic feet per hour (about 4 cubic feet per minute) should be adequate. Our suggestion is to get a variable speed fan for ambient room ventilation and keep a thermometer on the wall. That way you can vary the ventilation to suit the needs of ambient heat conditions in the room. Grainger is an excellent source for ventilation equipment. (See www.grainger.com)

VENTILATION FOR THE KILN

In addition, we recommend our VENT-SURE downdraft kiln vent system. This will take care of most of the venting of the fumes of the kiln, will improve uniformity of firing in the kiln, and will help maintain the oxygen level in the kiln (which is important for certain glaze effects as well as good element life). See the separate instructions in this book for the VENT-SURE vent system. Although you can use other kiln venting systems please note that the VENT-SURE is c-UL-us listed for use with the Easy-Fire kilns. If UL listing is an issue then you may want to ensure that another brand of vent will be acceptable to your local authorities. Also if you use another brand of vent be sure to check with the vent manufacturer for specific installation requirements with our specific kiln model. We specifically do not recommend a plate mount type vent (like the Envirovent or Orton Plate Mount Vent) for use with our kilns. We have seen kiln bottoms crack from lack of support. Although the Orton Stand Version of their Kilnvent is sturdy and provides good support for at least a 23" diameter kiln like the e23S and e23T or JD230, the largest Orton stand mount vent is only 24" square vs our 29" square stand for the e28S and e28T or JD2927. If you must use the Orton vent then we recommend you use the

INSTALLATION & PREORDER INFORMATION FOR L&L KILNS

24" square Stand Version for all Easy-Fire and 23" or 29" Jupiter kilns. You can use there Junior Vent for the Doll kiln and the 18" Stand Vent for the J18 and J18X. Do use an Orton Vent with the DaVinci Series because there is no way to get good support for the kiln.

CARBON MONOXIDE MONITORING

We recommend the use of a carbon monoxide monitor in your kiln room. These are available from good hardware stores or from Graingers for about \$50. (See www.grainger.com)

VENTING CODES

The following information is provided courtesy of The Edward Orton Jr. Ceramic Foundation.

OSHA has set standards for carbon monoxide exposure of 35 ppm (parts per million) for long-term exposure and 200 PPM for short-term exposure. Independent testing has shown that fumes near the kiln can exceed 200 PPM near the kiln during the firing of greenware. This can cause headaches, fatigue, sore throats and nausea. When properly installed and operated, a downdraft vent removes all harmful fumes and provides a safer working environment.

Most states and localities have set venting requirements for firing kilns in public places. Your local and state health board should have this information. The Uniform Mechanical Code says that you must vent ceramic kilns. It says that you can use a canopy-type hood (and gives specific requirements for such use) or that "listed exhaust blowers may be used when marked as being suitable for the kiln and installed in accordance with manufacturer's instructions." Our Vent-Sure vent is UL listed and is appropriate to meet this ventilation requirement. If you decide to use a vent other than the UL listed Vent-Sure vent make sure you check with the manufacturer of the vent to be certain that it is an approved application. L&L takes no responsibility for improperly installed vents or kilns nor do we take responsibility for the use of other vents with our kilns. The manufacturer of the vent must specifically approve it for use with our kiln.

Note about canopy type vent hoods: While canopy type vent hoods can be suitable for venting a kiln from

a safety point of view, they will not give you the superior advantages of a downdraft type vent like our Vent-Sure. A downdraft type vent pulls the rising hot air down to the bottom of the kiln which helps even out the firing. In addition it provides uniform distribution of oxygen in the kiln. You don't have to open the lid or the peepholes when using a downdraft vent.

See ASTM Standard C1023 Appendix for ventilating an electric kiln. xxxx. This states "Ventilation is recommended when firing an electric kiln. Adequate ventilation may be achieved by means of air exchange through cross ventilation, exhaust hoods or self-contained air handling systems. To determine the appropriate ventilation, it is recommended that you consult a local licensed Heating, Ventilation and Air Conditioning Contractor." (put in Easy-Fire as well)

HVAC AND AIR CONDITIONING ISSUES

Kilns put out a lot of ambient heat. If you need to size HVAC units to handle this see the BTU chart in the INSTALLATION section of your manual (*jupiter-btu.pdf* or *davinci-btu.pdf*) for a chart of maximum BTU output for each of our kiln models.

OTHER ACCESSORIES NEEDED

SHELVES AND POSTS

You will of course need an appropriate number of shelves and posts to load your ware. If you are buying a replacement kiln you may already have the correct shelves. Check the sizes and make sure they will fit into your new kiln. For instance, if you are buying a new 10 sided kiln that has 3" brick and you had a 10 sided kiln with 2-1/2" brick the old shelves will not fit (21" diameter shelves vs. the newly needed 20" diameter shelves. Note that shipping can be expensive for a shelf kit and that you will save a considerable amount of money if you order a shelf kit with your kiln.

GLOVES AND GLASSES

It is usually a good idea to have a pair of heat resistant gloves for removing peephole plugs and unloading the kiln. If you intend to observe witness cones while the kiln is firing you should wear shaded safety glasses. See *parts.pdf* in the PARTS section of your manual.

INSTALLATION & PREORDER INFORMATION FOR L&L KILNS

CONES

It is a very good idea to fire your kiln every time with witness cones. See the whole LOG, CONES, TIPS & CERAMIC PROCESS section in your manual for more information on this. They can easily be purchased after you get your kiln. You can buy pyrometric cones from either your local clay or ceramic supplier or directly from Orton see (www.ortonceramic.com).

SELECTING AN ELECTRICAL CONTRACTOR

You will need a quality electrical contractor who is knowledgeable, skilled and qualified to handle the job. A quality electrical contractor:

- 1) Complies with state and local codes and regulations.
- 2) Carries the proper business and workers compensation insurance.
- 3) Is knowledgeable on a wide range of new equipment, technology and design procedures.
- 4) Has a local facility, and is willing to have you visit.
- 5) Is prompt and courteous and provides fast, reliable service – attempting to perform service at your convenience.
- 6) Is neat and well groomed. This neatness should be reflected in their vehicles and offices as well as their personal appearance.
- 7) Provides a detailed written proposal, clearly outlining the work to be done and the agreed upon cost, including labor and materials. Make sure you understand every word of any contract before you sign it.
- 8) Asks in detail about any problems and offers understandable solutions.

When considering an electrical contractor:

- 1) Ask for references. Find out if other customers were satisfied. Check with the local Better Business Bureau regarding any filed complaints.
- 2) Compare price. Get bids from a few contractors. Make sure you give each contractor the same specifications and materials needed for the job.
- 3) Remember! How a company treats you now reflects how they will treat you if there's a problem. A quality electrical contractor listens to your problems, understands what you want accomplished and is willing to follow up after the work is completed.

FINAL CHECKLIST

VOLTAGE

- 208 Volts
- 220 Volts (non US)
- 240 Volts
- 380 Volts (non US)
- 480 Volts

PHASE

- 1 Phase
- 3 Phase

AMP CAPACITY

- I have checked the amperage rating of the kiln with the intended voltage and checked (or had an electrician check) to see that I had enough amps available in my building power supply.

VENTILATION

- I have a room fan
- I will also be using a kiln vent
- I am going to manually vent the kiln but I have adequate room ventilation for this.

FLAMMABILITY ISSUES

- I can install the kiln at least 12" away from any wall (18" is preferred). 36" is required from any combustible walls.
- My kiln room floor is non-flammable.
- I will use an insulated floor and check temperatures when the kiln is at its highest point
- I have a dedicated fire extinguisher or sprinkler system for the kiln room or kiln.

SAFETY STANDARDS & CODES

- UL or c-UL-us listing is required.
- UL or c-UL-us listing is not required.
- You are using a licensed electrician who knows the National Electrical Code and any other local codes.

OTHER SAFETY ISSUES

- Children will be adequately protected from hot kiln.
- There will be wall or other permanent fixture to attach the kiln lid safety chain (on the Jupiter kilns without the Easy-Lift Hinge) to a nearby wall or post. (This is self contained on the DaVinci kilns).

DURA-FIRE INSTRUCTION MANUAL

WIRING



L&L Kiln's patented
hard ceramic
element holders
protect your kiln.

DURA-FIRE INSTRUCTION MANUAL



L&L Kiln's patented
hard ceramic
element holders
protect your kiln.



L&L Kiln Mfg. Inc. • 505 Sharptown Rd. • Swedesboro, NJ 08085
 Phone: 856.294.0077 • Fax: 856.294.0070 • Email: sales@hotkilns.com • Web: hotkilns.com

TRU-VIEW

Multi-Zone Digital Pyrometer System

For Real Insight Into Your Manual Kiln

The TRU-VIEW Digital Pyrometer system can be factory or field installed. The metal box includes a bracket for mounting the pyrometer system to either the kiln or a wall. It is available with from 1 to 5 thermocouples. All thermocouples have 42" long lead wires - although with the digital pyrometer the length of these can be shortened or extended because they do not affect the calibration of the digital pyrometer.

A tool to help you accurately control your L&L manual kiln: Know the real temperature in your kiln at all times. Get accurate low temperature control. Accurately control cool-down.

Control temperature gradients: With the unique design of the Jupiter and DaVinci manual switching circuits, temperature differences are easily corrected at the maturing point by measuring the temperatures to detect any difference between top and bottom. Necessary adjustments are easily made by the zone switching controls on the kiln.

More flexible placement of loads: You may place your load to best advantage without regard to temperature differences.

Better glaze results: This is possible when used with the Jupiter or DaVinci switching action. Control over the flow of glaze is possible by varying the time and temperature. This may be accomplished by holding your temperature at a particular level. By observing your pyrometer and using your switches to their best advantage, it is possible to hold your temperature constant for varying periods of time until through practice you are able to obtain far superior glaze and body results.

Quality construction: The pyrometer is an accurate digital pyrometer - much more accurate over a full range than our older analog meters.

Three year Limited Warranty: See hotkilns.com/warranty.pdf for details.



Description	With 8 Gauge Thermocouples		With Pyrocil Thermocouples*	
	Item No	Price	Item No	Price
- P/1 Pyrometer System with one (1) Thermocouple	T-G-PC00/00	\$220.00	T-G-PCIN/00	\$245.00
P/2 Pyrometer System with two (2) Thermocouples	T-G-P200/00	\$305.00	T-G-P2IN/00	\$355.00
P/3 Pyrometer System with three (3) Thermocouples	T-G-P300/00	\$335.00	T-G-P3IN/00	\$410.00
P/4 Pyrometer System with four (4) Thermocouples	T-G-P400/00	\$370.00	T-G-P4IN/00	\$470.00
P/5 Pyrometer System with five (5) Thermocouples	T-G-P500/00	\$400.00	T-G-P5IN/00	\$525.00

* The Pyrocil Thermocouples are metallic sheathed thermocouples. See hotkilns.com/tc-metallic.pdf for details.

L&L CONE 10 KILN WASH

TECHNICAL DESCRIPTION

L&L High temperature (cone 10) kiln wash is available in one pound and five pound boxes. It is made from a mixture of Silica, kaolin, and Alumina Hydrate.

PRICES

One Pound Box: \$3.45

Part Number:M-G-WASH/01

Five Pound Box: \$9.75

Part Number:M-G-WASH/05

DIRECTIONS FOR USE

Kiln wash is applied to kiln shelves to protect them from glaze drips. On a washed shelf, drips can be easily removed without gouging or marring the kiln shelf.

Mix the kiln wash with water to a thin cream consistency. Apply only one coat at a time. Use a wide paintbrush or utility brush (a 2" - 3" wide, soft bristle brush generally works best). Three individually fired-on coats of kiln wash are preferable.

APPLYING KILN WASH

- 1) Make sure the floor of the kiln and the tops of the shelves are coated with kiln wash. This will protect these surfaces from melting glaze and ceramics.
- 2) Do not coat the bottom or sides of the shelves.
- 3) Do not apply kiln wash to the brick sides or element holders.
- 4) Apply the kiln wash to the thickness of a post card.
- 5) The only purpose of kiln wash is to prevent any glaze that drips from a piece from sticking to the floor or shelves. This saves both the piece and the floor or shelves. If dripping should occur, simply remove dripping and cover the spot with new kiln wash.
- 6) When you are applying kiln wash to your shelves for the first time, it helps to dampen the top of your shelves with a wet sponge or a water-filled spray bottle first. This makes the kiln wash go on easier and more evenly.

7) For the kiln wash to really protect the kiln shelves it is best to apply three separate coats. In addition it is best to fire each coating separately. (If you brush one coat on, let it dry and then brush on another, you could actually be brushing off the first in the process, so ideally each coat should be fired on). The shelf can be used while firing the kiln wash on, so theoretically you would put one coat on, load the shelves and do your test firing of the kiln. The second coat would be fired on in the first bisque and the third coat in the second bisque or first glaze (whichever comes next). Fire at least to cone 018 - hot enough to give the kiln wash enough adherence to the shelf to prevent it from coming off in the second coating. Note that some people get away fine without three firings of the kiln wash. However, we include this recommendation as a "best practice".

8) If you notice that your kiln wash is flaking off, use a paint scraper (or something similar) to remove any loose bits, then reapply kiln wash. If glaze drips onto your shelf, use the paint scraper to pop the glaze drip off and clean up any loose areas around the area, then dab some more kiln wash in the bare area.

PROGRAM TO QUICKLY DRY KILN WASH

Here is a program that will dry the kiln wash in a hurry:

In the Vary-Fire section:

Press **Enter Prog**, Press **'1'**

Press **Enter**, Press **'1'**

Press **Enter**, Press **'60'**

Press **Enter**, Press **'200'**

Press **Enter**, Press **'600'** (for 6 hours, 400 for 4 hours, 800 for 8 hours etc of hold time at 200 degrees)

Press **Enter**, Press **9999**

Press **Enter**, Press **START**

APPLYING KILN WASH TO A DAWSON

If you have a Dawson kiln sitter, put kiln wash on the cone supports (not sensing rod) for accurate cone action. Clean off the old wash and reapply new wash each time you fire or when it begins to chip away.



KILNS BUILT TO LAST

L&L Kiln Mfg. Inc. ♦ 505 Sharptown Rd. ♦ Swedesboro, NJ 08085
Phone: 856.294.0077 ♦ Fax: 856.294.0070 ♦ Email: sales@hotkilns.com ♦ Web:
hotkilns.com

CERAMIC BOOKS FOR SALE BY L&L KILN MFG

What Every Potter Should Know

222 pages

by Jeff Zamek.

For every successful pot you create, chances are there are a few you abandoned along the way. Now you can save many of those spoiled pieces by learning solutions to some of the most common pottery problems. No longer will you waste time and money on a piece that requires only minimal repairing, if only you knew the right techniques. Author Jeff Zamek has researched just about every mishap that can occur in ceramics and has learned how to either prevent or correct them. He provides information in easy to grasp segments to guide you through new glaze formulas, new clay body formulas, kiln firing techniques, clay/glaze defects, and much more.

Jeff Zamek began making pots in 1968 and received B.F.A./M.F.A. degrees from Alfred University, College of Ceramics in Alfred, New York, in ceramic art and design. Zamek then spent several years teaching college level ceramics in the Northeast. He has developed clay body and glaze formulas for ceramics supply companies throughout the United States.

Price:\$28.00

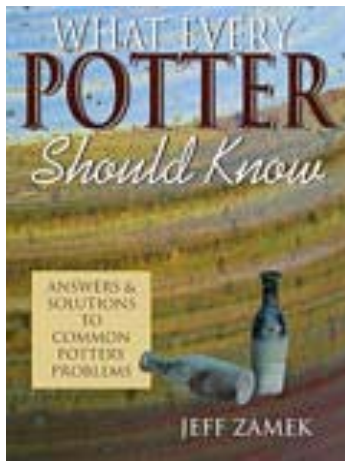

CERAMIC BOOKS FOR SALE BY L&L KILN MFG

Electric Kiln Ceramics

284 pages

By Richard Zakin

Over the last decade, the safety, convenience, and economy of the electric kiln have made it extremely popular for the home studio. Electric Kiln Ceramics, Second Edition, contains information for the potter available nowhere else: an exhaustive review of clays, glazes, and techniques developed exclusively for use in the electric kiln.

Electric Kiln Ceramics begins with an introduction to the electric kiln and the various clays and glazes best suited to its use. Both commercial and homemade clays and glazes are discussed, and recipes are provided for slips and glazes for different firing temperatures. Special glazes (wood ash: majolica, tzu chou, and crystal glazes), the application of oxidation surfaces (intaglio glazing, painting, wax resist, and sgraffito methods), and loading and firing are also explored in depth.

This second edition provides state-of-the-art health and safety information. All-new photography showcases the work of artists from around the world with more than 200 color and black-and-white examples of contemporary electric-fired work. Also included are the history of the electric kiln, how to purchase or build your own kiln, and advice on routine maintenance.

This inclusive guide will assist you in using the electric kiln to produce clear, brilliant colors and richly textured surfaces. Provides you with completely revised glaze recipes, information on commercial glaze for low fire and updated health and safety information.

Richard Zakin has repeatedly stretched the capabilities of oxidation fire, not only as an artist, but as an investigator. He demonstrates in this book that the electric kiln potter can obtain clear, brilliant colors, richly textured surfaces, and complete control over a range of effects. He supports the assertions through compounds, formulas, and examples to produce the most thorough reference ever published on the silent fire.

Zakin is a professor of art at the State University of New York at Oswego, and is a prolific writer, highly regarded for his technical articles.

Price: \$40.00

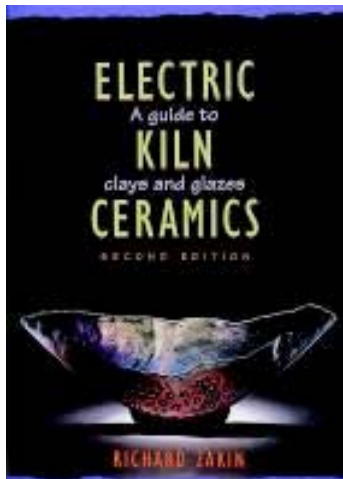

CERAMIC BOOKS FOR SALE BY L&L KILN MFG

Mastering Cone 6 Glazes

168 pages, 42 color photos, 15 graphs and is softbound in a durable, water resistant cover
By Ron Roy and John Hesselberth

Ron Roy and John Hesselberth, two potters well known for their expertise in glaze chemistry and for their concern for helping potters make glazes that are suitable for their intended use, have collaborated to write a book that is certain to become a classic for the potters working at Cone 6.

Do you want your glazed to be durable in use and attractive? Do you want to be sure they will not leach significant quantities of metals into food or drink? This is the first book to address these questions in-depth. A wide variety of extensively tested glaze recipes are included as well as detailed guidance on formulating your own glazes.

Do you want to be sure glazes don't craze for on coming out of the kiln or after extended use? Or perhaps you do not want glazes that craze for a decorative effect. This is the only book that gives an in-depth discussion of how to prevent (or causing) crazing and the related problems of shivering and dunting,

Do you want to know how you can test your glaze and pottery to be sure they are suitable for their intended use? A number of practical, inexpensive, in-studio test are described that you may want to use.

All of this information and more is explained in terms potters can readily understand. This is a ground-breaking book that studio potters, teachers of ceramics, students and others will find to be an invaluable source of useful reference information on cone 6 glazes. A lot of the material is also applicable to Cone 10.

Price: \$40.00

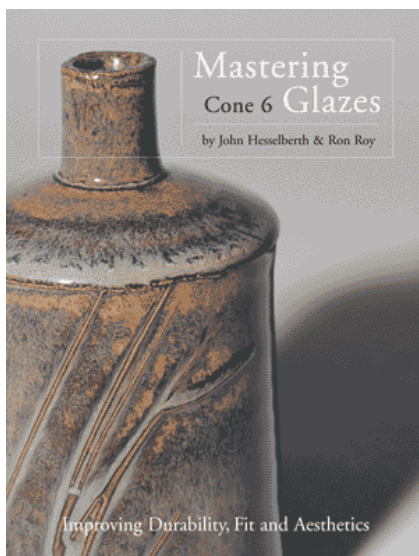

DURA-FIRE INSTRUCTION MANUAL

TROUBLE
SHOOTING



L&L Kiln's patented
hard ceramic
element holders
protect your kiln.

GENERAL L&L KILN TROUBLESHOOTING GUIDE

TABLE OF CONTENTS

TROUBLESHOOTING GUIDE	3
RELATED L&L GUIDES	3
CAUTION INSTRUCTIONS	3
REGULAR KILN MAINTENANCE	3
BASIC ELECTRICITY FOR TROUBLESHOOTING	3
TROUBLESHOOTING BRICK PROBLEMS	3
TROUBLESHOOTING ELEMENT PROBLEMS	3
TROUBLESHOOTING FIRING PROBLEMS WITH CONE PACKS	3
THE CERAMIC PROCESS	3
REPLACEMENT PARTS	3
SERVICE	3
GENERAL TROUBLESHOOTING TOOLS AND METHODS	3
BASIC TOOLS REQUIRED	3
KEYS TO GOOD TROUBLESHOOTING	4
SAFETY FIRST	4
DEFINE THE VARIABLES	4
ELIMINATE VARIABLES ONE AT A TIME	4
TROUBLESHOOTING CHECKLISTS	4
TROUBLESHOOTING CHECKLIST	4
CONTROL DISPLAY DOESN'T SHOW ANYTHING (AUTO KILN)	4
On/Off Switch	4
Control Fuse	4
Branch Fusing	4
Plug & Cord (if you have one)	4
Circuit Breaker / Power Source	4
Internal Wiring	5
Short Circuits	5
Control Transformer	5
Control Board	6
THE KILN DOESN'T HEAT AT ALL (MANUAL KILNS)	6
DISPLAY READS FAIL (AUTO)	6
DISPLAY READS 2400 or CPLt WHEN IT STARTS UP (AUTO)	6
DISPLAY IS NORMAL BUT KILN WON'T HEAT UP (AUTO)	7
Programming	7
Wiring	7
Control Board Outputs	7
Bad Power Relays	7
Bad Elements	7
KILN FIRES UNEVENLY	7
Peepholes	7
Lid Seal	7
Elements	8
Loading	8
Firing with Cones	8
Thermocouple Offsets	8
Vent System	8
LAG & AUTOLAG SETTINGS	9
CONTROL ERROR CODES (Auto)	9
THE KILN FIRES UNEVENLY (MANUAL)	9
KILN FIRES TOO HOT OR COLD	9
Firing with Cones	9
Easy-Fire vs Vary-Fire (Auto)	9
Hold Times	10
Control Settings	10
Thermocouple Drift	10
KILN STALLS	10
KILN FIRES SLOWLY	10
Bad or Wrong Voltage	10
Element Aging	11
Power Relays	11
Bad Wiring	11
Wiring in the Kiln	11
Element Connections	12
Heat Leakage & Vents	12
Single vs Three Zone Control	12
LAG Setting	13
Autolag Setting	13
ShtO (Shut-Off) Setting	13
PId Setting	14
Adding More Insulation	14
KILN HEATS TOO FAST	15
Voltage	15
Elements	15
THE KILN FIRES SLOWLY (MANUAL)	15
TROUBLESHOOTING VARIABLES	15
THE KILN BODY	16
Layout and Configurations	16
Firebrick	16
Firebrick Problems and Repair	16
Lids and Floors	16
Stainless Steel Bands	17
Kiln Stand	17
Jupiter Stands with Vent Collection Box	18
Hardware	18
Econo/Jupiter Standard Lid Hinge	18
Jupiter "Easy-Lift, Easy-Load" Spring Loaded Hinges	19
DaVinci Lid Hinge and Counterbalance	19
Element Holders	20
Element Holder Replacement	20
HEATING ELEMENTS	20
CIRCUIT	20
POWER SUPPLY	20
INSULATION	21
ELEMENTS	21
ELEMENT TROUBLESHOOTING	21
KILN ATMOSPHERE & VENTING	21

GENERAL L&L KILN TROUBLESHOOTING GUIDE

INSTALLATION CODES	21
GENERAL ROOM VENTILATION	21
MANUAL VENTING	21
POWER VENTING	21
THE CONTROL	22
MANUAL CONTROL	22
AUTOMATIC CONTROL	22
SERVICEABILITY	23
SAFETY WARNING	23
GENERAL INFORMATION	23
REPLACING WIRE TERMINALS	23
MANUAL KILN SWITCHBOX	23
DIAGNOSE A SLOW-FIRING MANUALLY	
CONTROLLED KILN & GENERAL TACTICS	24
MANUAL DAWSON KILN SITTER	28
BASICS	28
The kiln-sitters are used either as a safety backup or as the primary turn-off control.	29
How the Kiln-Sitter/Timer works	29
A) The timer	29
B) The shut-off mechanism	29
Potential Problems with the Dawson	30
FOR MORE INFORMATION	30
AUTOMATIC CONTROL BOX	30
General Information	30
Can you restart the kiln?	33
Worst Case Scenario for Restarting After an Error Code	33
Errd	34
Err1	35
FAIL	35
No display (power) at all, even after 15 seconds.	36
Seems like the kiln is under-firing or over-firing slightly	37
Calibrating the DynaTrol	37
Stalling caused by shorting of thermocouples	37
PYROMETERS	38
Tru-View Pyrometer System	38
THERMOCOUPLES	38
Metal Sheathed Type K Thermocouples	39
Type S Platinum thermocouples	39
For More Information on Thermocouples	39
Thermocouple extension wire	39
Cones measure heat-work	39
THE POWER SUPPLY	39
Safety Warnings	39
The Data Nameplate	40
If you are the electrician:	40
Use copper wire	41
Chart of wire and amperage	41
Voltage Drop over distance	41
Power cords	41
TROUBLESHOOTING AN EXISTING POWER SUPPLY	42
Circuit breakers	42

Wire size too small	42
Corrosion	42
Dedicated circuit	42
Melting power cord	42
CONCLUSION AND REMINDERS	42
FEEDBACK	42

CAUTION - ELECTRICITY CAN KILL

Many of the tests described in here are performed under power. They should be done **ONLY** by someone who is familiar with electrical safety such as an electrician or trained maintenance person. We identify any test that is live with a **CAUTION** statement. We describe these tests in detail so that an electrically trained person who doesn't specifically understand kilns can do the troubleshooting - the level of simplicity described is not

GET A DIGITAL MULTIMETER!

If you want to do much of the troubleshooting described here and not be dependent on a kiln service person then get this tool. It is not hard to use! Without it you are only guessing at the origin and severity of an electrical problem based on how the kiln is acting. A slow-firing kiln may just have old elements, or the elements could be fine but the incoming voltage from your power supply could be low, or fluctuating. Unless you test with a multimeter, you could purchase new elements and run the risk that you might be wasting money and time without solving the problem. Be forewarned however: Testing electrical circuits is very dangerous and potentially deadly if you do it incorrectly. It could result in electrocution! If you don't feel comfortable doing this hire an electrician or get someone to do it who is qualified. That being said - many of the tests described in here just require testing for resistance - which is done with the kiln unplugged. **AS LONG AS THE KILN IS UNPLUGGED YOU ARE SAFE.**

Radio Shack or any good hardware store will carry inexpensive digital multimeters for around \$40-\$50. The meter shown below was purchased at Home Depot for about \$120 and includes an amp probe to measure amperage. The meter you buy should be digital simply because the analog type is not very accurate. You must be able to see ohm (resistance) readings to the first decimal place. Being able to see that ".7" on the meter is the difference between "I think it may be your elements..." and "I know it is your elements..."

GENERAL L&L KILN TROUBLESHOOTING GUIDE

TROUBLESHOOTING GUIDE

This manual is meant to assist and educate kiln owners and service technicians. This is mostly specific to Jupiter, DaVinci and Doll kilns. For older L&L kilns see our more general troubleshooting guide: hotkilns.com/trouble.pdf. The Easy-Fire kilns have their own separate troubleshooting instructions (easy-fire-trouble.pdf) and so does the Liberty-Belle (liberty-belle-trouble.pdf)

Please email or fax any corrections or suggestions that you have so that we may incorporate this information into our next revision. We have gone into great depth in many areas and, while some of this may seem overwhelming, much of this is geared towards helping customers who want to be as self-sufficient as possible. Our basic philosophy at L&L is to make kilns that last. No small part of having a reliable well-firing kiln is good maintenance. This information is provided as a service and is believed to be accurate. However, it is the reader's sole responsibility to interpret and use this information correctly. Please visit our web site to download the latest versions of all our instructional and technical information.

RELATED L&L GUIDES

CAUTION INSTRUCTIONS

See cautions.pdf in the OPERATION section of your Instruction Manual. THIS IS SOMETHING YOU MUST READ.

REGULAR KILN MAINTENANCE

See maintain.pdf in the OPERATION section of your Instruction Manual. THIS IS SOMETHING YOU MUST READ.

BASIC ELECTRICITY FOR TROUBLESHOOTING

See troubleshoot-electricity.pdf in the TROUBLESHOOTING section. Also see hotkilns.com/volts.pdf for more in-depth information about electricity for kilns.

TROUBLESHOOTING BRICK PROBLEMS

See troubleshoot-brick.pdf in the TROUBLESHOOTING section for information on firebrick problems and instructions on how to repair firebrick problems.

TROUBLESHOOTING ELEMENT PROBLEMS

See troubleshoot-elements.pdf in the TROUBLESHOOTING section for information on elements problems and instructions on how to install elements and element holders.

TROUBLESHOOTING FIRING PROBLEMS WITH CONE PACKS

See troubleshoot-cones.pdf in the LOG, CONES, TIPS section.

THE CERAMIC PROCESS

See ceramic-process.pdf in the LOG, CONES, TIPS section.

REPLACEMENT PARTS

See parts.pdf in the PARTS section. .

SERVICE

See service.pdf in the SERVICE section.

GENERAL TROUBLESHOOTING TOOLS AND METHODS

BASIC TOOLS REQUIRED

The minimal toolkit necessary for effective troubleshooting and fixing of electric kilns contains a digital multi-meter to measure ohms and AC voltage, and an assortment of screwdrivers, nutdrivers, wrenches, pliers, cutters, wire strippers and wire terminal crimpers. As you work on your kiln you will see what types of tools you need, like a 3/8" nut-driver, needle-nose pliers without the cutting part so the tips will close all the way. wire cutters heavy enough to cut the element terminals, wire strippers and wire terminal crimpers. No special tools are required for maintenance on L&L kilns.

GENERAL L&L KILN TROUBLESHOOTING GUIDE

KEYS TO GOOD TROUBLESHOOTING

SAFETY FIRST

Pay attention to electrical safety. Don't get electrocuted and don't guess.

DEFINE THE VARIABLES

Define all variables of the situation, and how they could potentially interact with and affect each other in each unique case you come across.

ELIMINATE VARIABLES ONE AT A TIME

Eliminate variables one by one to expose the problem variable(s). Asking questions can do this to some degree. Electrical testing, examining shards of ware or cone, or examining the interior of the kiln usually can supply the rest of the story. Good troubleshooting is based on logic.

TROUBLESHOOTING CHECKLISTS

TROUBLESHOOTING CHECKLIST

The following checklists are shorthand methods for troubleshooting your kiln. Much of what is in here is also covered more extensively in the rest of this troubleshooting guide but in a more theoretical and in-depth way. These checklists can help simplify the process.

CONTROL DISPLAY DOESN'T SHOW ANYTHING (AUTO KILN)

On/Off Switch

1) Make sure the On/Off Switch is turned on. Turn it on and off.

Control Fuse

1) Check control fuse in side of control box. Twist open the fuse holder and physically check the little fuse. You can see if the metal element inside is melted if it is blown. You can also use your digital multimeter to check continuity across the fuse.

Picture of the on/off switch and fuse holder opened.

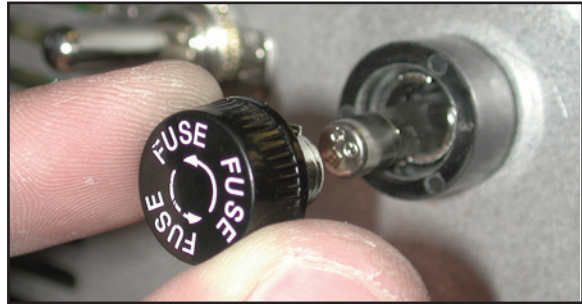

Branch Fusing

1) Check the branch element circuit fuses inside the control box. All kilns with more than 48 amps and many 3 phase kilns have branch fuses.

Plug & Cord (if you have one)

1) Make sure the power cord is plugged into the receptical. Reseat plug.

2) With power off examine the electrical cord. Look for burned or melted areas and breaks or pinched sections. Look closely at the head of the plug. If there is an internal problem with the wires and the plug parts you won't be able to see it but you may detect a softening or melting of the plastic at the plug head.

3) With power turned on and panel open check voltage at the Power Terminal Block. If you see no voltage there then you know something is wrong with the power source. **CAUTION: This test should only be done by an experienced person familiar with electricity and its dangers.**

Circuit Breaker / Power Source

1) Check voltage at the receptical. **CAUTION: This test should only be done by an experienced person familiar with electricity and its dangers.**

GENERAL L&L KILN TROUBLESHOOTING GUIDE

A Fused Disconnect Switch:



- 2) Check circuit breaker or fused disconnect switch to make sure they are turned on. Sometimes circuit breakers need to be turned on and off to reset them.
- 3) If you have a fused disconnect check the fuses with your voltmeter for continuity. **CAUTION: This test should only be done by an experienced person familiar with electricity and its dangers.**
- 4) Make sure fuses or circuit breaker is the proper amperage and type. See wiring diagram for details.
- 5) Test for voltage at the main power supply as close to the kiln as possible. **CAUTION: This test should only be done by an experienced person familiar with electricity and its dangers.**
- 6) **CAUTION: If you have a 208 volt rated kiln and are trying to run this on 240 volts you will create a dangerous situation. This is dangerous because the kiln will draw more amps than it is rated for which will overload the power wires and other components and could cause a fire.** Chances are the circuit breaker will trip or the fuses will blow first.
- 7) Check voltage to the kiln. **MAKE SURE YOU ARE NOT USING A 3 PHASE KILN ON A SINGLE PHASE CIRCUIT.**

Internal Wiring

- 1) Unplug kiln or turn off at circuit breaker or fused disconnect and open up panel. **CHECK VOLTAGE TO BE SURE.** Make sure that all the wires inside the control panel are connected. See photograph on page 2 and also the Wiring Diagram. Specifically look at the wires that go from the power connection block to the on/off switch, then to the control fuse and then to the control transformer.

Short Circuits

Do all the following with the kiln unplugged.

- 1) Check for short circuits. Look for any signs of burnt wires. This might indicate a short circuit. A way this might happen, as an example, is that frayed wires at the end of a wire connector might touch each other.
- 2) Check for worn wires that may have shorted against the case. Examine wire insulation. If the wire insulation has become frayed or deteriorated from heat, the wires could short to the metal casing which is electrically grounded.
- 3) Look for dirt. Some dirt (such as carbon compounds) are electrically conductive. This is generally not the case with ceramic materials but some can be. Vacuum out if you see dirt.

NOTE: Usually a short circuit will trip the circuit breaker for the kiln or the fuses in the fused disconnect switch if you have one. You will then not see any display on the DynaTrol. Turn your circuit breaker on and off, and check fuses on the fused disconnect and control fuse.

Control Transformer

CAUTION: These tests should only be done by an experienced person familiar with electricity and its dangers.

- 1) If none of these solve the problem then you could have a bad control transformer. To check the transformer operation test with your digital multimeter. It should read 240 volts across terminals 4 & 7 and 24 volts across terminals 5 & 8. This is a live test so be very careful not to touch any of the wires - remember there is 240 volts in the panel and this can electrocute you. If you are not getting proper voltage (or any voltage from the transformer and you are getting it to the transformer then you need to replace the transformer.

GENERAL L&L KILN TROUBLESHOOTING GUIDE

Control Transformer:

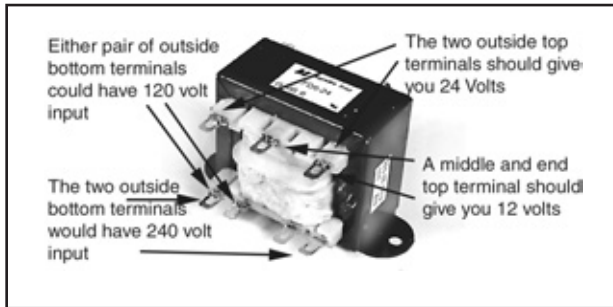

2) If there is 240 (or 220 or 208) volts coming into the control transformer (terminals 4 & 7) and there is no voltage coming from the transformer (across terminals 5 & 8) then you have a bad control transformer and it needs to be replaced.

3) If there is no voltage coming into terminals 4 & 7, then test for it at the Power Terminal Block where the power cord comes in. If there is power there then look for a bad connection or wire between the power connection block and the transformer, i.e. a bad toggle switch, wire, or ½ amp fuse holder. If power is not there then go further back on the line and measure the voltage. Keep going until you find voltage, then look for the problem between that point with the voltage and the last point checked that had no voltage.

Control Board

1) If the transformer is OK and you know you have voltage going to the control board but the control still shows no display then the control board needs to be replaced.

THE KILN DOESN'T HEAT AT ALL (MANUAL KILNS)

1) Check many of the same things in the above section on Automatic kilns - power supply, branch fuses, short circuits, cord, etc.

2) Make sure the infinitely variable zone input switches are turned on (if included on your kiln). There is a "click" in the "off position at "12 O'clock". Full on is the "click" position just to the right of this (1 O'clock).

3) Infinitely Variable Zone Input Switches may have

failed.

4) Check to see if Dawson Timer is set properly. (If it is at "0" the kiln will not fire.

5) Check to see if the Dawson plunger is not pushed into place.

DISPLAY READS FAIL (AUTO)

1) Usually **FAIL** will be seen flashing along with a **tC1**, **tC2** or **tC3** indicating which thermocouple has failed.

2) Remove the offending thermocouples connection wires from the Terminal and bind the red and yellow wires together with electrical tape. The control should read room temperature for that thermocouple (approximately 130°F because of the thermocouple offsets).

3) If it does read room temperature then the thermocouple is probably bad and needs to be replaced. If the control does not read room temperature then there is either a bad thermocouple extension wire or the control is bad.

4) Redo the test by putting a small jumper like a paperclip across the thermocouple terminals directly on the Dynatrol board. If the control now will read room temperature then you have a bad thermocouple wire. If it does not read room temperature then the control is definitely bad and needs to be replaced.

DISPLAY READS 2400 or CPLt WHEN IT STARTS UP (AUTO)

Even though you know the kiln is not that hot. This indicates thermocouple circuit failure.

TECHNICAL NOTE: This is called thermocouple upscale protection. If the control senses a lack of millivoltage (an open circuit) it interups this as the highest temperature the control could reach. This automatically ensures that the control will not call for power.

1) Check thermocouple end. Examine end carefully. Sometimes there can be a crack that opens up while the kiln is hot but appears to be normal when the kiln

GENERAL L&L KILN TROUBLESHOOTING GUIDE

is cold. If the end of the thermocouple looks severely corroded and you are getting Error codes then it is best to replace the thermocouple.

A thermocouple end that will still work but is getting close to creating a problem:

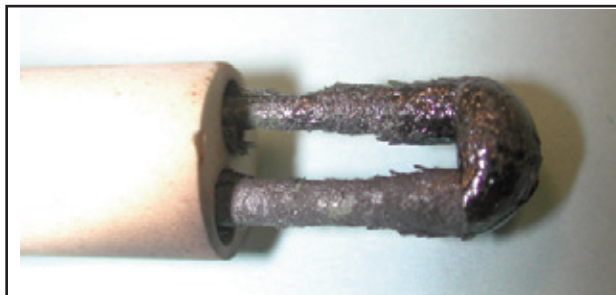

2) Check thermocouple circuit. For instance check to make sure that all the thermocouple lead wires are firmly connected. Check where the thermocouple lead wires go into the ends of the thermocouples. Are the wires loose? Tighten the screws on the ends of the thermocouples to be sure you have a tight connection. Check for corrosion. Check where the thermocouples connect to the Dynatrol. Try pulling off each connection and reseating it. This can scrape away corrosion that may have built up. Check for melted wires.

3) A very easy check is to check resistance (ohms) . Remove the thermocouple lead wires from the thermocouple head and check resistance with your meter. If the thermocouples and circuit is normal then you will see a resistance of about .9 or 1.0. If you see an **OL** in your meter then you have an open circuit somewhere which is probably a bad thermocouple.

DISPLAY IS NORMAL BUT KILN WON'T HEAT UP (AUTO)

Programming

1) Make sure you have programmed the kiln properly and it is supposed to be firing. Do you have a **Delay Time** or a **Preheat Time** in your program? (Hit **Review Prog** button to find out).

Wiring

1) Unplug kiln or disconnect from live power by turning off circuit breaker or fused disconnect switch. Open

panel. Check all power wires for firm connections.

2) Visually inspect the power wires coming from the Power Terminal Block to the inputs of the Power Relays. Reseat all the spade connectors to rub off any oxides and to ensure a good connection.

Control Board Outputs

1) It is possible that the the internal switches on the control board could be bad. You can test that by checking to see if you find voltage (12 volts DC) between any of the output contacts on the control board to ground (any green wire). **CAUTION: This test should only be done by an experienced person familiar with electricity and its dangers.**

Bad Power Relays

1) You should be able to hear contactors going on and off with a clicking noise when you first turn on the kiln and it is supposed to be heating up. If not try turning the kiln off and then back on again and restarting the program. Of course if you don't hear the relays it only tells you that they aren't firing. The problem could be in the control for instance not telling the relays to fire. If you do hear relays and the kiln is not heating then you know the problem is in the power circuit **AFTER** the relays.

2) With power on and panel open check voltage before and after each of the contactors while the kiln is firing. **CAUTION: This test should only be done by an experienced person familiar with electricity and its dangers.**

Bad Elements

See *troubleshoot-elements.pdf* in the TROUBLESHOOTING section.

KILN FIRES UNEVENLY

Peepholes

1) Plug up Peephole holes in the kiln to prevent drafts.

Lid Seal

1) Check to make sure that door/lid is sealing properly. If door/lid is not sealing against top brick correctly a bright red glow will be visible around the

GENERAL L&L KILN TROUBLESHOOTING GUIDE

door/lid seal when kiln is operating. (A little of this is OK). Also excessive heat loss can be felt around seal. Rub seal high points down with sandpaper until no more than 1/16 of an inch gap is found at any point along seal. Note that the gap at the top will definitely appear larger than any gap you see between the kiln sections. This is partly because the lid actually bows down in the center of the lid when it heats up and the edges consequently rise slightly. Just check for an UNEVENNESS in this gap which will cause an excessive heat loss.

2) If door/lid is excessively cracked or worn or has holes in it this may cause drafts in the kiln. Replace door/lid.

This shows a crack in a lid that is OK. Cracks are a natural event with refractory slabs. As long as the crack does not create a large pathway for heat to escape and remains stable it is OK to leave as it. See the section in the back called CRACKS IN THE TOP & BOTTOM:



Elements

1) Elements may have differentially changed in resistance. Check element resistance (see *troubleshoot-elements.pdf*).

2) Empty the kiln. Then turn kiln on using a fast program like FAST GLAZE until elements are red. Open the door carefully and observe the elements to see if they all seem to be glowing about the same amount. **CAUTION: The power does not turn off when you open the lid. Be careful not to put your hand inside the kiln while it is on. Dangerous electric shock could result if you touch an element.**

3) There is a neat diagnostic program within the Dynatrol. This is handy to use when your kiln is first delivered and set up to make sure it was done

properly. It can also be useful in seeing if an element has burned out. To use this diagnostic program enter the following sequence when the display says **Idle**.

4) Press **OTHER, 4, 4, 3**

5) Keep pressing **OTHER** to cycle through the menu options until you get to **dIAG** and then press **ENTER**.

6) Open the lid of your kiln. You will see each zone of the kiln turn on for one minute each, starting with zone #1, the top zone. The control will display **OUt1**, then **OUt2**, then **OUt3** as it cycles through this sequence. **CAUTION: The power does not turn off when you open the lid. Be careful not to put your hand inside the kiln while it is on. Dangerous electric shock could result.** This will tell you if the kiln sections are in the wrong order or if the wires are somehow crossed in the control panel. If this is the case the zones will not turn on in the proper 1, 2, 3, order.

Loading

1) The Dynamic Zone Control of the EASY-FIRE kilns can compensate for many uneven loading situations. However, if you are having a problem with uneven firing try to vary the way you load it to match the firing characteristics of the kiln. For instance if it typically fires hot at the top then put more weight in the top to absorb that heat.

2) Be sure to put posts under the bottom shelf. The bottom shelf should be at least 1/2" to 1-1/2" above the floor of the kiln.

Firing with Cones

1) Try using cone packs in all sections (top, center, bottom) of the kiln and keep records of what happens. See *troubleshoot-cones.pdf* in the LOG, CONES, TIPS section of your Instruction Manual.

Thermocouple Offsets

Thermocouples can drift in their accuracy over time and this can happen at different rates for each thermocouple. If one thermocouple reads at a different temperature than another thermocouple this can cause unevenness in the kiln. Read about Thermocouple Offset in section 4.3.1.8 in the

GENERAL L&L KILN TROUBLESHOOTING GUIDE

DynaTrol Reference Manual (*dynatrol-instruct-blue.pdf* in the CONTROL section) and the Calibration section in the *dynatrol-basic-operation.pdf* in the OPERATION section of your Instruction Manual.

Vent System

1) Is your vent system on and pulling air? You can check this with a source of smoke in a cold kiln. (If you burn a small piece of paper near the holes on the bottom of the kiln with the vent on and THE KILN OFF you can see if the smoke is being drawn into the holes. You can also check this by feeling the output of the vent when the kiln is at high temperatures. The air coming out should be quite warm to the touch (about 110 Deg F to 140 Deg F). The Vent-Sure will aid in keeping your kiln uniform by drawing hot air from the top of the kiln towards the bottom. It counteracts the natural rising of the heat. If you want to increase draw first close the Bypass valve on the Bypass Collection Box under the kiln. See the Vent-Sure vent instructions. You can also increase the size of the vent holes in the bottom of the kiln. You can also try taking out the top peephole plug. See *ventsure-instruct.pdf* in the OPTIONS section of your Instruction Manual.

LAG & AUTOLAG SETTINGS

Check the LAG setting (see information in these instructions under "KILN FIRES SLOWLY". To get the kiln to fire more evenly you may want to decrease the LAG setting and perhaps turn the AUTOLAG OFF.

CONTROL ERROR CODES (Auto)

See the control instructions and the explanation later in these instructions.

THE KILN FIRES UNEVENLY (MANUAL)

1) Many of the above issues for automatic kilns also apply to manual kilns.

2) Multi section kilns like our J Series, X or T Series DaVinci, older G Series Colorado and SQ Series Dyna-Kilns have infinite control over the input to

each section or zone. Firing chamber uniformity depends upon how a kiln may be loaded and how the input to each zone is adjusted. Normally a kiln is on "low" for a period of time, then set to "medium" for the next period of time, and finally on "high" until shut-off by either Dawson kiln sitter or other control device such as a program control. Often firing as above may end up with a difference in temperature in various sections of the fired load or zone. To correct this without the use of a pyrometer system requires a trial and error method, such as using multiple cones in various zones of the kiln. After shut-off carefully note the temperature variations and by small adjustments to the sectional input controls when on "high" attempt to tune this difference out. Since cones only indicate end of firing temperature one has no idea of how the uniformity is developing as the temperature is increasing. We recommend a TRU-VIEW multi-thermocouple pyrometer system which indicates the temperature of each zone. (These are available from L&L). The system includes a thermocouple located in each kiln section. A switch allows the operator to switch from zone to zone very rapidly and thereby indicating each zone temperature. Adjustments to the infinite control will then be indicated. This method indicates zone temperature at all times and is also a great help in cooling a kiln. Often a kiln should cool slowly requiring a period on "low" heat. In such a procedure the Dawson Kiln Sitter is reset carefully to "on" position (ignore the cone which has initially shut this kiln off) but make absolutely certain you are on "low" heat to prevent overfiring. Do not leave your kiln; keep checking. CAUTION: Such a procedure requires knowing the temperature of the kiln and kiln sections and requires manual shut-off of the kiln. Simply shut-off power manually (by turning off the various input/zone switches) and cause the Dawson to manually shut-off by depressing the weight of the Dawson Kiln Sitter.

KILN FIRES TOO HOT OR COLD

Firing with Cones

1) On the next firing make up "cone packs", one for each thermocouple. A cone pack is a set of three cones, standing in a line. The target cone is the cone

GENERAL L&L KILN TROUBLESHOOTING GUIDE

number you are firing to and is in the middle. The one in front of it is one cone number lower, and the one behind it is one cone number higher. Use Large Self-Supporting Cones. You can purchase these through your ceramic supply distributor. They come 25 cones per box and are quite inexpensive. See *troubleshoot-cones.pdf* in the TROUBLESHOOTING section of your Instruction Manual.

Easy-Fire vs Vary-Fire (Auto)

Keep in mind that the Easy-Fire programs feature Orton software that adjusts the final temperature based on the speed of firing. This in effect adjusts the heat-work and hence the actual cone that the kiln fires to. This feature is not in the Vary-Fire programs. You have to input the final set point temperature in a Vary-Fire program.

Hold Times

Be very careful with hold times. Even a fairly short hold time of 10 minutes can dramatically increase the amount of heat work and hence the cone that the kiln fires to. On the other hand you can use the hold time to increase the heat-work to compensate for under-fired work. Just test this in small increments. There is a great program available for free from Orton's web site that allows you to calculate this with some precision.

Control Settings

1) The ceramic thermocouple protection tubes introduce a known error into the system. This is covered in the Operational Instructions but bears repeating here. The temperature that is measured by the tip of the thermocouple is approximately 70 Deg F cooler than the actual kiln temperature. We have found through extensive testing that the best way to compensate for this is to put in a Thermocouple Offset of + 50 Deg on each thermocouple (setting is **0050**) and a Cone Offset of -20 (setting is **9020**) for EACH cone that you fire to (on the Easy-Fire Programs or **9030** on cones 022 to 017). We have already programmed the control with this information so that you don't have to do it. However, we also provide step-by-step instructions on how to do it in the Operational Instructions. If you are using the VARY-FIRE programming then use a Thermocouple

Offset of plus 70 (setting is **0070**).

Thermocouple Drift

Thermocouples drift in their accuracy with time. You may have to make further adjustments in the Thermocouple Offset or Cone Offset settings over time.

KILN STALLS

1) If for some reason the thermocouple wires touch the hot kiln case they may melt and fail. The result of this is that the kiln can "stall out", say **CPLt** prematurely or display any other number of other random error codes. It may refuse to increase in temperature, and the kiln will just run on and on. If it is re-started it may work fine for a while. What happens is that the millivolt signal in the TC wire goes to ground, or the two wires in the TC wire are "electrically" connected by the stainless steel melting through the insulation and the "temperature" is then taken right there, not in the kiln. However, the signal received can be so foreign to the microprocessor that the kiln will just stall. The specific Thermocouple Lead Harness needs to be replaced.

2) Thermocouples close to end of their useful life can cause some of these same problems.

3) Sometimes excessive ambient temperatures (over 125°F) around the control can cause stalling too.

4) Corroded connection points can also cause stalling.

KILN FIRES SLOWLY

Bad or Wrong Voltage

1) Check your voltage. Do this at the kiln at the Power Terminal Block with the control panel open or check it at your fused disconnect box. **CAUTION: This test should only be done by an experienced person familiar with electricity and its dangers. You need to see what the voltage is when the kiln is firing.** Low voltage will make the kiln fire considerably slower. For instance a kiln designed for 240 volts will have 25% less power when operated on 208 volts. Check voltage at your panel and where the kiln is

GENERAL L&L KILN TROUBLESHOOTING GUIDE

connected. Check the voltage when the kiln is firing and when it is not firing. Sometimes the high amperage draw of the kiln will cause a voltage drop at the kiln. A voltage drop of 5 to 10 volts is not uncommon and is to be expected. If your voltage drop is more than that then you may have a problem with your electrical supply.

2) Make sure no other large electrical appliances such as a clothes dryer or electric oven are on when you are operating your kiln. This may cause a voltage drop which would slow the kiln down.

3) Voltage may vary in your area depending on season and time of day. Frequently there are "brown outs" during the summer months in some areas. This is when the electric utility reduces the voltage. Try firing at night after peak electrical use hours. You can use your Delay feature to do this easily. Find out from your local utility company when the end of the peak period of electrical use is. Some utilities offer preferential rates for using electricity at night because it is cheaper for them.

Element Aging

See *troubleshoot-elements.pdf*.

Power Relays

1) Power Relays may cause poor transfer of power to elements when they have been used for a long period of time. It is not always a total failure - which is of course harder to troubleshoot. If these are suspected replace them.

Bad Wiring

1) Have an electrician check your wiring. We have seen aluminum wire cause intermittent problems with allowing enough voltage through. We do not recommend aluminum wiring although some electricians will swear by it. The problem with it is that aluminum oxide, which is formed from heat, is a resistor while copper oxide is not a resistor. With kilns you will often develop some heat in the electrical lines. If all connections are perfect and the wire is oversized you probably will not have a problem - but why take that chance? Make sure your wires are of the proper size and that all connections are good.

WIRES WILL GET HOT

Unlike many other appliances that use electricity (like motors) kilns are called a "resistive load." This means that there will be a continuous pull of steady electrical power for many hours. Even with properly sized wire this will generate SOME heat in the wires. This is one reason we recommend against using aluminum wire for a power feed. If you look carefully you will see that we have **OVERSIZED** our internal power wires far in excess of their rated capacity. In addition all our power wire is rated for very high temperatures. The larger the wires the less resistance in the wires and the cooler they will operate.

2) Check your circuit breaker for proper operation. These sometimes go bad over time.

3) If all the elements are firing and the kiln is still firing too slow check the amperage draw of the kiln under a full load. **CAUTION: This test should only be done by an experienced person familiar with electricity and its dangers. You need to see what the voltage is when the kiln is firing.**

4) You can tell if all zones are firing by pressing the number **8** on the control numeric pad. You will see one little light per zone under the numbers on the control display. If you see two dots on an e23S or e28S then you are firing at full load. If you see three dots on an e23T or e28T then you are firing at full load. See if the amperage drawn is the same as what the kiln is rated for. See the product literature and/or data nameplate on the kiln for the rated amperage draw. There is also a complete table of this information in the Installation Instructions part of this manual. For instance, a model e23T rated for 240 volts, Single Phase should draw 48.0 amps. If it is substantially less than the rated amperage draw and your voltage is within 5% of the rated voltage (for instance 230 volts for a 240 volt unit), then chances are the elements have changed in resistance. This will require element replacement.

GENERAL L&L KILN TROUBLESHOOTING GUIDE

Pressing the number "8" will turn on 2 or 3 small LEDs that indicate whether the various zones are firing.

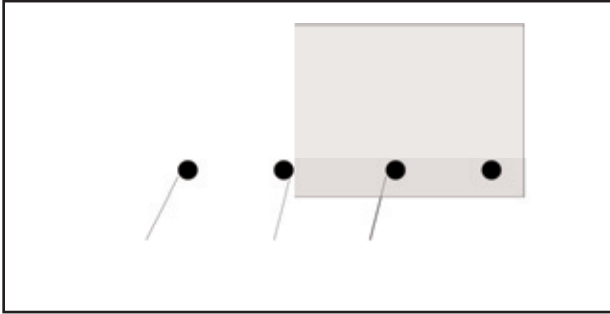

Wiring in the Kiln

- 1) Unplug kiln.
- 2) Trace wiring for missing or bad connections.
- 3) Check wiring against wiring diagram.
- 4) Check for corroded connectors or connectors that have frayed wires. Replace if you see this.
- 5) Make sure all kiln sections are plugged in (if applicable to your model). Make sure ALL plug connections are good and not oxidized.

Element Connections

- 1) The holes where the elements go through the firebrick walls are too large. This could cause too much heat to escape from the kiln thereby overheating the element terminals. This can be remedied by lightly stuffing non-RCF ceramic fiber in the element holes. (See the Parts List for non-RCF fiber). You can stuff this in from the inside of the kiln using a sharp tool like a very small screw driver.
- 2) Check to see if the element ends are twisted properly. They should be twisted clockwise around the terminal screw. If the twist is too loose this could generate extra heat at the element ends. Check for corrosion on the terminal. If there is corrosion sometimes you can remove it with a wire brush.

Photo of element terminal with element end twisted around it properly:



- 3) The element connection hardware may not be tight enough. A loose connection can generate heat and cause oxidation of the hardware which in turn will cause a worse electrical connection (because of resistance) and more heat. Replace with new hardware.

Heat Leakage & Vents

- 1) Make sure peephole plugs are in.
- 2) Make sure hole for vent is proper. Check Vent-Sure instructions for proper hole sizes.
- 3) If you are using a different brand of vent make sure it is the appropriate size for your kiln. Check with the vent manufacturer and tell them how many cubic feet are in your kiln.
- 4) If your lid or bottom is cracked check to see if it seems to be leaking much heat at high temperatures. Patch or replace if extreme. (SOME IS OK).

Single vs Three Zone Control

- 1) Three zone control will slow a kiln down. It helps even out the temperatures in a kiln by shutting off one or more zones while firing. In addition zone control introduces other issues like **LAG** that sometimes complicate a firing. **The first thing to try if you are getting a slow firing is to switch the kiln to single zone operation.** That may get you back into operation quickly. Then, if that makes the problem go away you can fine tune the specific issue within the zone system that is causing the problem.
- 2) Normally Jupiter and DaVinci kilns are

GENERAL L&L KILN TROUBLESHOOTING GUIDE

programmed to be either two or three zones. You can easily change this to be single zone operation.

3) Press **OTHER, 4, 4, 3**

4) The display says **notC** This stands for “number of thermocouples”.

5) To run the kiln using only one thermocouple press **ENTER** at the **notC** prompt. You will then see **0003** or **0002** (depending on whether it is currently programmed for three zones or two zones). Then press **1**, then **ENTER**. The display will then say **StOP**. All the zones of the kiln will turn on and off simultaneously when you program the Dynatrol to use only one thermocouple.

6) To run the kiln using only two thermocouples press **ENTER** at the **notC** prompt. You will then see **0003** or **0001** (depending on whether it is currently programmed for one zone or three zones). Then press **2**, then **ENTER**. The display will then say **StOP**. When you program the Dynatrol to run using only two thermocouples the bottom zone and the middle zone go on and off simultaneously. If you have a three section kiln the bottom section and the middle section will work off the middle (#2) thermocouple and they will fire together. This configuration can be an interesting option to help speed up the kiln but still get some advantage from the zone system.

7) To run the kiln using three thermocouples press **ENTER** at the **notC** prompt. You will then see **0002** or **0001** (depending on whether it is currently programmed for one zone or two zones). Then press **3**, then **ENTER**. The display will then say **StOP**. If you choose to do this thermocouple #1 must be in the top zone, thermocouple #2 in the middle, and #3 in the bottom. All three zones will operate independently, tied to their respective thermocouples.

8) To exit the **OTHER-4-4-3** series of menus without doing anything press **OTHER** until you come to **Pct**. Then press **ENTER** twice. You will then see **CPL**, and then **IdLE**, **tC2**, and the current temperature cycling in the display again.

LAG Setting

1) **LAG** is the zone control setting that determines the temperature differential allowed between zones.

2) The lower the **LAG** number the more even the firing. However, this can slow the kiln down considerably. It is somewhat like a convoy - the kiln can only move as fast as its slowest zone (although of course it is more complicated than this because the faster zones help heat the slower zones).

3) The default **LAG** setting is **25**. If you increase this to **50** or even **75** it allows the kiln to fire its zones with a greater differential which will speed the kiln up.

4) Press **OTHER** until you see **LAG**.

5) Hit **ENTER**.

6) You will see **LAG** and a number such as **0025** flash.

7) Input a new number (from 5 to 99) with the keypad and hit **ENTER**. We do not recommend less than **25** unless you have a very critical process and where speed is not an issue like on low fire. A very low number like **0005** could really slow the kiln down. If you want lower than **0025** try **0015** or **0010**.

8) **AUL6** (Autolag) will now display, flashing with either **On** or **OFF**. See next section.

Autolag Setting

1) **Autolag** automatically disables the **LAG** control until the end of the firing.

2) Having **Autolag** turned **On** speeds up the firing considerably. Most ceramics applications do not require exceptional uniformity until the end of the firing. With **Autolag On** the **LAG** feature is disabled until the last 45°F of the firing when it comes back on to its programmed setting. Basically this allows the faster sections to help pull the slower sections along.

3) However, for glass and other industrial applications turning **OFF** Autolag is probably recommended.

4) Press **OTHER** until **LAG** appears.

5) Press **ENTER**.

6) As soon as you press **ENTER** after entering the **LAG** setting (you can leave it as is - just press **ENTER**) you will see **AUL6** for approximately two seconds, and then see either **On** or **OFF**.

7) Press **1** to toggle between **ON** and **OFF**.

GENERAL L&L KILN TROUBLESHOOTING GUIDE

8) Then press **ENTER**

ShtO (Shut-Off) Setting

1) This option is used to shut off the automatic feature in the Dynatrol that holds the hottest part of the kiln at each segment's set point until the average of the three (or two) thermocouples reaches that set point. This can have a dramatic effect on speed of firing and is worth trying to see if it helps you if you are having a problem.

2) When you press **OTHER, 4, 4, 3**.

3) Press **OTHER** until **ShtO** is displayed.

4) Pressing **ENTER** here allows you to toggle, using any number key, between **On** and **OFF**.

5) **On** means that as soon as the hottest zone gets to the segment's set point the entire kiln switches to either the "hold time" or the next segment. This will result in a quicker firing.

6) **OFF** means that the Dynatrol will not let the hottest zone's temperature rise until the average temperature of the three zones reaches that segment's set point. Then the kiln can begin the "hold time" or the next segment. This will result in more even firing.

7) When you have the setting you want shown in the display (**On** or **OFF**) press **ENTER**. **CPL** will display for a few seconds and then **IdLE**, **tC2** and **current temperature**.

PId Setting

1) This setting generally should be left at its factory default because it is hard to predict the changes that it will create in your firing. However, a full explanation is given for more advanced users who want to experiment with this.

2) This setting comes pre-programmed at the factory for 65%. Basically this setting determines how much help the middle zone of the kiln gives the bottom zone of the kiln when the bottom zone is lagging behind during heating. This comes into play when the bottom zone is on 100% of the time. With this feature, the middle zone of the kiln will come on the programmed percent (PId) of the time that the TOP zone comes on, if the bottom zone is on all the time. Tests showed

that if the bottom was on 100% of the time, the top zone was generally on 90% of the time, but the middle zone was on only about 40% of the time. By programming a higher percent you can greatly speed up your firings. (you will have to experiment, try the factory setting 65% then try maybe 100% and compare your results). Basically the higher the **PId** setting the faster the firing at the potential price of unevenness.

3) As your elements age firing by firing, this setting will activate earlier and earlier in the firing because the bottom will be working at 100% earlier and earlier. This will allow the artificial inflation of the center's temperature sooner and sooner. Because this center is heating based on mathematics now and not its own thermocouple's reading, it will have a longer and longer period of time to get hotter than the top and the bottom. In some cases this can lead to gross unevenness. You may find yourself dialing down the PId to something like 50% or 60%. Remember that if it is set around 40% (its normal operating percentage) or below, the thermocouple's reading then will be the control for that section, not the mathematics of the **PId** feature.

4) When display flashes **IDLE, tC2** press **OTHER** see **rSet**. Press **4, 4, 3**. See **notC**

5) Keep pressing **OTHER** to cycle through the menu options until you get to **PId**.

6) Press **ENTER**. See **PCt, 0085** cycling.

7) Press any number from **0** to **150**, see the number you have entered preceded by a zero like **0120** if you entered **120**. Press **ENTER**, see **CPL** or **StOP** for a few seconds, then **IDLE**, etc.

8) Pressing **ENTER** here allows you set another percent setting that can help a slow, heavily loaded kiln fire faster.

Adding More Insulation

1) In L&L's top loading kilns an additional bottom may be placed under the original bottom. This will improve the insulation in the kiln, thereby slowing heat loss and speeding the firing time. You can also put a 2" layer of calcium silicate on top of the stand beneath the bottom of the kiln.

GENERAL L&L KILN TROUBLESHOOTING GUIDE

2) Also try raising the height of the kiln from the floor or putting a reflective stainless steel or aluminum sheet under the kiln. All these things keep the floor from absorbing the radiant energy from the kiln and will improve heat up times (as well as bottom of the kiln uniformity).

3) Put a 1" layer of non-RCF ceramic fiber on the lid. This is completely non-hazardous which is important in this application because you will be releasing fibers into the air when you move it while loading. While this is a somewhat extreme measure we have found that a disproportionate amount of the heat loss from a kiln is through the top. Non-RCF ceramic fiber is soluble in the body and is considered totally safe. (See the Parts List).

4) Whatever you do be sure NOT to put the kiln directly on the floor. If the floor is cement or other hard non-flammable material it will absorb the heat from the kiln. If the floor is wood or other flammable material you will create a very DANGEROUS situation which could cause a serious fire.

KILN HEATS TOO FAST

Voltage

1) Check your voltage. Some people may have high voltage like 245 volts where you should nominally have 240 volts.

2) Make sure you don't have a 208 volt kiln hooked up to a 240 volt circuit. **This is dangerous because the kiln will draw more amps than it is rated for which will overload the power wires and other components and could cause a fire.**

Elements

1) Check element ohms and compare with factory values. (See CHECKING ELEMENT OHMS).

THE KILN FIRES SLOWLY (MANUAL)

1) Check many of the same things as you would for an automatic kiln like element resistance, wiring, etc.

2) Switches are sometimes defective.

3) Relays or contactors may cause poor transfer of power to elements when they have been used for a long period of time. Examine contacts for wear. Replace contactors if contacts are worn or pitted.

4) Make sure all elements are firing. You can do this by simply looking inside the kiln while the elements are on. They should all be glowing a similar color red. CAUTION: In most kilns the power does not turn off when you open the lid. Be careful not to put your hand inside the kiln while it is on. Dangerous electric shock could result.

12) If all the elements are firing and the kiln is still firing too slow check the amperage draw of the kiln under a full load, i.e. with all Infinitely Variable Zone Input Switches on 100%. See if the amperage drawn is the same as what the kiln is rated for. See the product literature and/or data nameplate on the kiln for the rated amperage draw. For instance, a model J230 rated for 240 volts, Single Phase should draw 43.93 amps. If it is substantially less than the rated amperage draw and your voltage is within 5% of the rated voltage (for instance 230 volts for a 240 volt unit), then chances are the elements have changed in resistance. This will require element replacement. You can check element resistance by disconnecting the elements and checking the elements with an ohmmeter. See your instructions or check with factory for proper resistance.

TROUBLESHOOTING VARIABLES

For most L&L kiln problems the variables can be organized into these categories:

1) The Kiln Body

- a) firebrick
- b) element holders
- c) lid and floor
- d) metal case
- e) stand
- f) hardware

GENERAL L&L KILN TROUBLESHOOTING GUIDE

2. Elements

- a) elements
- b) element connections
- c) element configurations
- d) element replacements.

3) Atmosphere

- a) atmosphere in the kiln while firing.

4) The Control

- a) switch box
- b) automatic control
- c) kilnsitter
- d) cones
- e) thermocouples and pyrometers.

5) The Power Supply:

- a) main power cord and receptacle
- b) or the powerblock
- c) wire and breakers.

Nearly all kiln related problems stem from one or more of these variables. We will go in-depth, starting with “The Kiln Body”

THE KILN BODY

The top of a JD230 showing the three sections that sit on top of each other and the control box mounted.

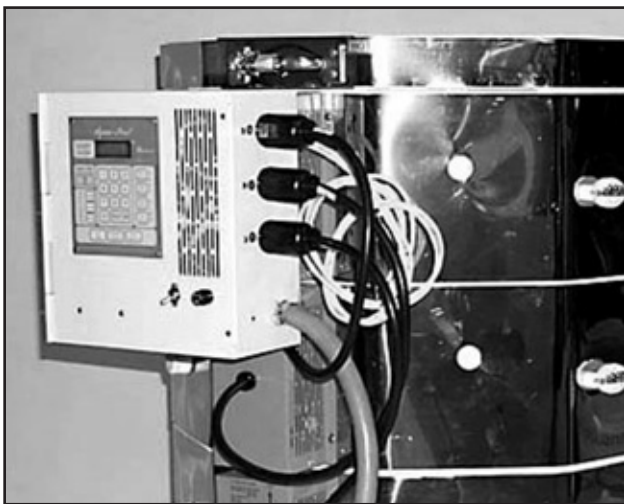

From the floor up most L&L kilns have a metal stand, a firebrick floor (sometimes containing an bottom

element), a firebrick body containing ceramic element holders in grooves, heating elements in the holders and a firebrick lid. Either an automatic or manual control and various accessories (such as vents and pyrometers) are used as well.

Layout and Configurations

In sectional, polygonal kilns, the kiln body rests on the upper-outer edge of the kiln floor. It should sit flat, but if it does not, you can carefully slide it back and forth on the kiln floor, sanding the high spots away until it does sit flat. The kiln body should also be level, particularly if the Dawson kilnsitter is being used. The kiln body is typically made of 9” high sections on the polygonal (J and K Series) and DaVinci (X & T Series) L&L kilns. In the past we have made 14” high and 6-1/2” high sections for J models. We continue to make 4-1/2” unheated sections for Jupiter kilns. The sections are stacked on top of each other up to 5 high (and for some special units even higher).

The bricks are not cemented together in these models, but are cut to fit exactly together to form a very stable, multi-sided (polygon), or gently curved, symmetrical shaped (DaVinci). No latches are used to connect the sections but these can be added if required. The new “Easy-Lift, Easy-Load” Jupiter hinge does allow you to attach up to three sections rigidly together.

Firebrick

The firebrick used on almost all top loading electric kilns is very soft and fragile. It is typically K-23 firebrick either 2 1/2” thick or 3” thick. This brick is used because of its remarkable insulating efficiency. It is much greater than some of the harder firebricks available. All L&L kilns have a special compound called brick facing applied to the inside surface of the firebrick to harden it once it is fired. It is a good idea to reapply this coating every so often over the years. A very thin coating is recommended for deep penetration of the compound into the brick.

Over the years, the brick will achieve a fine network of cracks throughout its body. This is caused by the expansion and contraction of heating and cooling. The geometry of polygon kilns is such that their

GENERAL L&L KILN TROUBLESHOOTING GUIDE

shape (and the stainless steel bands) will hold them together long after the brick itself would normally fall apart.

Firebrick Problems and Repair

See *troubleshoot-brick.pdf* for information on firebrick problems and instructions on how to repair firebrick problems.

Lids and Floors

The bricks in the lid and floor of the polygon and DaVinci kilns are cemented together, dried, cut and sanded flat. Then they are bound around the outside edge with a stainless steel band. These bands, like the ones surrounding the sections, have worm gear clamps attached to them which allow them to be tightened or loosened. These do get loose over time and need to be tightened periodically. The lids come with stainless steel "clips." which help to hold the lid in place. There are metal plates with a small 90° bend that are pinched between the stainless steel band and the brick to screw handles, door chains/supports and hinges into. The 90° bend on the clips also helps support the lid during lifting and lowering.

This shows typical clips that hold top firebrick to the stainless steel band, keeping the brick from slipping out of a band that becomes slightly loose.



Cracking in lids and floors is common in kilns, even new ones. It is almost unavoidable and mostly does not matter a great deal. The geometry of the lid or floor, the tightness of the stainless steel band and the fact that firebrick expands as it heats up and fills the cracks combine to render a cracked lid or floor almost a non-issue. In fact, L&L's largest kiln lids (for the T3400 Series) are made in two halves to allow for the heat expansion. The only concerns may be if the stainless steel band cannot be tightened (in which case long metal shims may be needed between the stainless

steel band and the brick) or if the crack is letting tiny chips fall into the ware. Two good solutions for the latter problem are either a shelf on posts placed over the ware to protect it or a very thin mixture of "brick facing" allowed to penetrate into the lid or floor around the crack to harden the brick. Too much brick facing on the lid can spall or flake off and cause problems.

Stainless Steel Bands

Each kiln section and the top and bottom have a stainless steel band wrapped tightly around them. This is how the kiln sections retain their shape. The steel has holes punched in it to locate peepholes, thermocouple holes, Dawson kilnsitter holes, etc. The bands are the same on the top section of the kiln as they are on the bottom section; different holes are used in different places and the firebrick may not be drilled through even though there is a corresponding hole in the stainless steel band. Worm gear clamps tighten the bands so that they fit snugly around the shaped bricks. Hinges are screwed into flat, galvanized or aluminized metal stiffening plates located behind the stainless steel bands.

GENERAL L&L KILN TROUBLESHOOTING GUIDE

Photo of the worm gear clamps used on L&L kilns. Sometimes welds holding these onto the case can fail. You can screw them on in most cases or, if all else fails you can screw the two ends of stainless steel together to make a repair. We recommend using a stainless steel screw. Keep in mind that, if you do screw the case together, that you may have to redo the repair at sometime in the future because it will not be adjustable.



Kiln Stand

The kiln stand is usually galvanized or aluminized steel (on Jupiter and Doll kilns), or painted angle iron (on DaVinci kilns). **It should be leveled before putting the kiln on it.** This can be done by placing metal shims under the legs of the stand, but not between the kiln floor and the stand. Be sure to use a level when doing this. Some older stands that L&L made were not galvanized or aluminized. These may have rusted over the years particularly under the corrosive conditions of kiln firing. You should replace a corroded stand because you could have a major disaster if the kiln were to fall over while it was firing.

Once the stand is level, place the kiln floor on it. If it wobbles at all you must shim the stand legs to correct this. If you fail to do this you may crack the kiln floor prematurely. It is imperative to use a proper stand. Without it, the non-flammable concrete/brick/tile floor will act as a "heat sink," transferring heat from the bottom of the kiln throughout the floor; this will result in cooler bottom zones and uneven slow firings and could also result in a fire.

If you want to add more insulation to the bottom (something we recommend in the case of slow firing) you can put another kiln bottom under your new kiln

bottom (people often have old kilns around that can be cannibalized for this purpose) or you can put a layer of calcium silicate under the kiln stand. See our parts list for information on this.

Jupiter Stands with Vent Collection Box

New stands have mounting studs in place around a hole in the middle of the stand for the attachment of L&L's venting system. See the section in this guide on "Venting" for more information as well as the vent system instructions for the specific requirements pertaining to size and number of exhaust holes for each different size kiln. Sometimes the studs on the stand do not quite line up with the holes in the vent system's "by-pass collection box". If this is the case try to determine which studs are not correct and either enlarge the holes in the bypass collection box (with a drill), or put a nut on the stud and tap it with a hammer, bending it slightly to go into the hole.

Hardware

The older L&L kilns had zinc plated steel hardware on the kiln case. The newer models use much more expensive stainless steel hardware because it will not rust like zinc plated steel. Old hardware can always be replaced with stainless steel hardware of the same type. (Also, the electrical hardware that we used to use before 2000 was nickel plated rather than all stainless steel).

Econo/Jupiter Standard Lid Hinge

The hinge for the lid has a pin connecting the lid to the kiln body. When the kiln is cool, it is critical that the pin pass through the bottom of the oval-shaped holes on the part of the hinge that is mounted to the kiln body. If the pin passes through the middle or top of these holes the lid may not sit properly, will rise up as the kiln heats up, and might crack. The firebrick expands as the kiln heats. The oval-shaped holes allow for this expansion by giving the hinge pin room to rise up as the bricks expand. If the pin cannot rise, brick will continue to push upward, and the back edge of the lid will suddenly become a pivot point that will mangle the brick and force all the lid's weight to ride on that point, possibly cracking it. Check this hinge pin position occasionally! To adjust it, loosen the mounting screws on the kiln body's part of the hinge

GENERAL L&L KILN TROUBLESHOOTING GUIDE

assembly (not the lid's section) and slide that part of the assembly up or down. The mounting holes here are oval shaped as well.

Close-up of a hinge assembly. It is important to have the hinge bar rest on the bottom of the oval hole in the hinge when the kiln is cold. This allows the lid to move up when the kiln expands.



The standard J Series lid (on J14 through J245 kilns) is meant to be used with door chains to stop the door from opening too far; a safety chain from the door handle to a hook secured in the wall keeps the lid from accidentally closing.

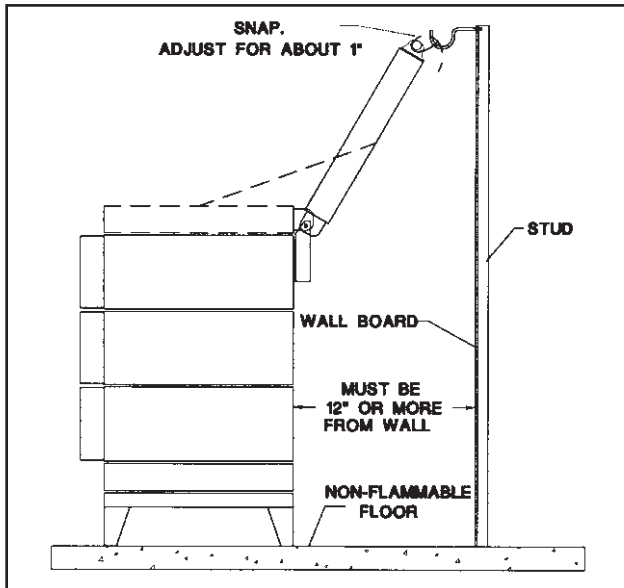

Older J2900 (29" diameter) Econo and Jupiter kilns have a tall metal backstop protruding from the hinge to keep the lid from opening too far. These have no door chains, but still use the safety chain to the wall hook system. This has been replaced with the new

"Easy-Lift, Easy-Load" spring loaded hinge system as standard on all 29" diameter Jupiter kilns as of April 2001.

Jupiter "Easy-Lift, Easy-Load" Spring Loaded Hinges

In April 2001 L&L started using spring loaded hinges as standard equipment on the twelve-sided (29") Jupiter kilns. These hinges are available as an option on the ten- and eight-sided Jupiters as well. They make opening the lid considerably easier, especially on the larger kilns. Do not consider using these hinges if you rely on being easily able to remove sections of your kiln to load it. These hinges cover about 20 inches of the height of the kiln body, or about two and one quarter sections of the kiln, and complicate the simplicity of removing the individual kiln sections. The 12- sided Jupiters already use a hinge that covers two sections, so the simplicity of removing sections on these models is not really compromised by the use of this better hinge. These new hinges also feature the ability to tie together up to three sections (or two sections and the bottom on 2 section kilns). The hinge itself is made from galvanized steel for corrosion resistance and is then powder coated.

There is no easy way to retro-fit an older kiln with one of these hinges, but it can be done. When these are installed at the factory, we use aluminized metal backing plates tapped in behind the stainless steel bands to give the hinge mounting screws something to latch onto.

DaVinci Lid Hinge and Counterbalance

The DaVinci hinges include a pole mounted counterbalance. These hinges still have the oval-shaped holes for the hinge pin to accommodate the expansion of the hot brick. The difference is a spring-loaded pole(s) and cable(s) that pulls up on the front of the lid. Normally these lids are maintenance free and quite safe when used with the safety chains that are attached to the pole(s).

GENERAL L&L KILN TROUBLESHOOTING GUIDE

A DaVinci with lid up and safety chains on



However, the lids are very heavy and the counterbalance will NOT keep them from closing on their own. They can be adjusted to do so, but this usually results in the lid lifting up during firing. There may be a fine line where the lid will not raise up during firing, and also may not fall down right away from its upright position. This fine line will be different for every kiln; even two identical kilns built at the same time will not act exactly alike. Always adjust the tension on the lid so it will not open up during firing, and ALWAYS use the safety chains when the lid is up.

The easiest adjustment points are the threaded connectors between the eyebolts on the front of the lid and the cable that connects to that point from the counter balance. A longer cable adjustment will mean a heavier lid, a shorter one will mean a lighter lid. A more crude adjustment would be to lengthen or shorten the entire cable itself. Do not try to shorten the springs or make adjustments to the cable inside the counter balance poles. Be sure to read the DaVinci Set-Up instructions that came with your kiln. (*davinci-setup.pdf*).

Element Holders

Each kiln section has a number of heating elements in it. These elements sit in ceramic element holders or channels that are set in the brick. They go all the way around the kiln.

A J2900 Brick set which includes two bricks and three rows of holders.



Elements are held in place by two small flanges on the back of the element holder that slide into specially routed channels in the brick. These eliminate the need for pins to hold the elements in place. These holders also help to retain the heat in the kiln during firing. The harder ceramic holders reflect the radiant heat of the elements back into the kiln better than the firebrick. When ordering replacement element holders it is best to measure their length and include that along with the kiln model number. There are "old-style" element holders in kilns built before January 1996. After January 1996 the element holders were made with a slightly larger channel for the elements. We recommend replacing the "old-style" holders with the more recent version. The reason for the "new-style" element holders was to accommodate the larger diameter of the "Heavy Duty" elements, which are still available for SQ, B, J and JD model kilns only if

GENERAL L&L KILN TROUBLESHOOTING GUIDE

they were built after January 1996, or have had all their element holders replaced since that date. Note that the new and the old style holders fit into the exact same milled slot that we have always put in our brick. Therefore you can put new holders in your old kiln. There is a slight offset between the two styles when you mix them but this won't cause any problems for the elements.

DaVinci kiln element holders (gray-colored) are rated for a higher temperature than the J model element holders. They are interchangeable in terms of their composition for most uses. It is the lengths which are different. They can be custom cut using a wet diamond saw if necessary. The DaVinci element holders will not slump together in the event of an over-fire as soon as the J model holders will, which is at about 2450°F. The DaVinci element holders are rated for about 3000°F, but are not quite as impervious to heat shock as the J model holders. Very sudden changes in temperature will cause them to crack sooner than the J model holders would. Since 2350°F is the maximum temperature for any L&L kiln, the higher-rated DaVinci holder would never see its temperature rating of 3000°F. In the event of an over-fire, however, the cost of repair is considerably less if the element holders have not slumped.

Element Holder Replacement

See *troubleshoot-brick.pdf* for instructions on how to replace element holders.

HEATING ELEMENTS

If you are having a problem heating your kiln up first look at the following issues:

CIRCUIT

Make sure the elements are wired according the wiring diagram. Some elements are in series, other kilns have parallel circuits. This makes a HUGE difference in how the kiln fires. See the explanation of circuits in *troubleshoot-element.pdf* in the TROUBLESHOOTING Section.

POWER SUPPLY

With the digital multimeter, the voltage to the kiln can be tested. The condition of the power supply lines and

connections can be determined visually.

INSULATION

Another variable is the condition of the insulation. Are there significant leaks? Large cracks in the lid or bottom? Do you fire with the peephole plugs open? The condition of the firebrick can be determined visually.

ELEMENTS

The elements are the least stable variable and should be examined before anything else. Use the multimeter to test the elements' resistance (ohms). Note that element resistance changes over time, the hotter and more often you fire the quicker they change. As the resistance goes up the kiln will slow down because it is getting less power.

You may not need to replace any elements, but you must eliminate or implicate them as a potential source of the problem.

ELEMENT TROUBLESHOOTING

See *troubleshoot-elements.pdf* in the TROUBLESHOOTING section of your instruction manual for more information on element problems, how to change elements and how to change element holders. See the section later in these instructions for a complete "walkthrough" of how to check elements in a manual kiln.

KILN ATMOSPHERE & VENTING

An electric kiln atmosphere rich in oxygen will make elements, kilnsitters, and thermocouples last as long as possible. All the materials used in L&L kilns like to be in oxygen. Fumes are generated by carbonaceous materials in clay, china paints and glazes containing oils, glue from decals, and certain glazes and other miscellaneous products. Fumes include carbon monoxide, sulfur oxides, hydrogen fluoride and metal vapors. These fumes are unhealthy and can adversely affect your work. You MUST VENT YOUR KILN if you are doing ceramics.

INSTALLATION CODES

See *install.pdf* in the INSTALLATION section for

GENERAL L&L KILN TROUBLESHOOTING GUIDE

more information on venting and codes.

GENERAL ROOM VENTILATION

Your kiln room should be dry and well ventilated. Never operate in an enclosed space unless you have good ventilation. Aside from issues of ventilating the fumes from the firing, the heat build up in an enclosed room could present a significant fire hazard. We recommend room ventilation of at least 10-25 times the cubic feet of the kiln per hour. For example, if a kiln has 10 cubic feet then 250 cubic feet per hour (about 4 cubic feet per minute) should be adequate. Our suggestion is to get a variable speed fan for ambient room ventilation and keep a thermometer on the wall. That way you can vary the ventilation to suit the needs of ambient heat conditions in the room. Grainger is an excellent source for ventilation equipment. (See www.grainger.com)

MANUAL VENTING

For many years people only vented their kilns by propping up the lids for the first part of the ceramic firing and taking out peepholes. You can still do this if you want. However, be sure to have proper room ventilation at least to get rid of the fumes that get vented to the room. Also be sure

POWER VENTING

We recommend our VENT-SURE downdraft kiln vent system. This will do most of the venting of the fumes of the kiln, will help cool the kiln, will improve uniformity of firing in the kiln, and will help maintain the oxygen level in the kiln (which is important for certain glaze effects). See our catalog for more information as well as hotkilns.com/vent.pdf. The complete installation instructions are at ventsure-instruct.pdf.

With a downdraft vent system air is pulled from tiny holes in the bottom of the kiln, which creates a slight negative pressure in the kiln. Just enough fresh air is drawn into the kiln to continuously replace the air being sucked out.

The heat in the kiln is then forced to move about. The slight downdraft effect of the vent system counteracts the tendency of heat to rise in the kiln (which would otherwise lead to uneven temperatures top to bottom

in the kiln). The amount sucked out should not be enough to compromise the rate of temperature climb, but must be enough to suck out all impurities (i.e. carbon, fluorine, water vapor etc.). L&L's Vent-Sure system only requires between one 1/4" hole and four 5/16" holes, depending on the size of the kiln. Too many holes can cause slower firings and a lower maximum temperature. In addition, the vent system ductwork could get too hot, and potentially melt, if there are too many holes. The Bypass Collection box (included with the Vent-Sure vent system) allows to adjust the amount of air being sucked from the kiln. Basically you want it to just vent the fumes. You may need to turn the vent off near the end of the firing especially if you are having a hard time reaching final set point.

One thing to keep in mind about venting at high temperatures is that you are actually venting less air the higher in temperature the kiln goes. This is because the air in the kiln expands with temperature so less molecules of air (which hold the heat) are being removed from the kiln the hotter the kiln gets.

Keep in mind that even the best vent systems cannot handle lots of smoke from newspaper or a lot of wax resist, and still let the kiln reach its highest temperature. To be sure you have not created an unsafe situation, you should check the temperature of the flexible ductwork while the kiln is at its maximum temperature. Most flexible aluminum ductwork is rated for at least 350°F, so if it is hotter than the rating you must plug up at least one hole. High Temperature Cement (available from L&L) works well for this. Kao-wool and other high temperature fiber products can work too. However, the fibers may get stuck in the fan motor, and potentially burn it out.

Other residue, particularly wax resist, can build up on the fan motor and the inside of the ductwork. A periodic cleaning will help. CAUTION: Be careful if you are doing wax resist. The wax will condense on the inside of the aluminum ductwork and this could be dangerously flammable. Check this periodically if you are doing this.

It is not necessary to put air-intake holes in the lid on sectional L&L kilns, although you can if you prefer. If the kiln is not sectional, or fits together extraordi-

GENERAL L&L KILN TROUBLESHOOTING GUIDE

narily well, you will want to drill air intake holes in the lid. The number and size of these holes should never exceed the number and size of the air exhaust holes.

A schematic drawing showing the Vent-Sure:

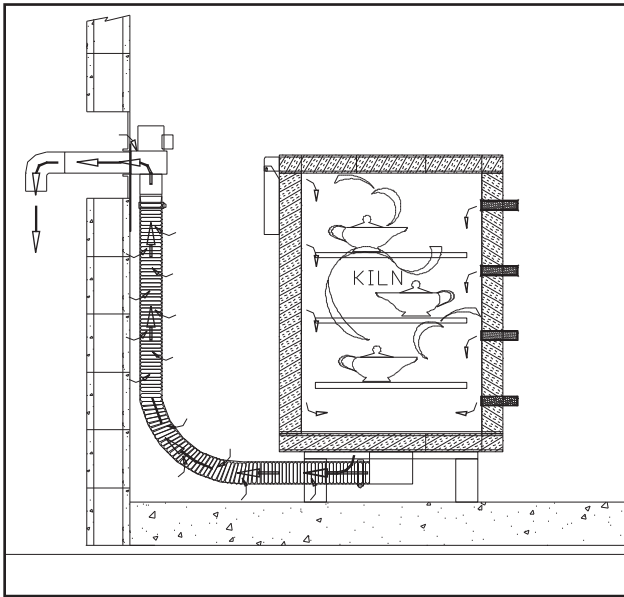

THE CONTROL

There are two basic types of control systems on L&L kilns.

MANUAL CONTROL

One is a “manual” control. The “manual” control refers to the switches which need to be adjusted during the firing. Even in a “manual” kiln the actual shut-off device is a simple automatic pyrometric device (the Dawson Kiln Sitter-timer). The manual control system consists of the switch box with either Hi-Med-Low switches or infinite type switches, one for each zone of the kiln, the Dawson Kiln-sitter, and possibly branch fuses and contactors (in larger kilns).

AUTOMATIC CONTROL

An “automatic” kiln consists of the switch box, an electronic temperature control, thermocouples, contactors and branch fuses in larger kilns. The electronic temperature control both automatically turns up the heat based on a program and shuts off the kiln when it reaches the correct final temperature. The thermocouples measure the temperature in the kiln.

SERVICEABILITY

L&L has designed their controls to be as far from the heat as possible, easy to repair on site and simple to remove and return to the factory if factory service is required or preferred.

SAFETY WARNING

In the United States and Canada, most electric kilns use high-voltage electricity, either 208 or 240 volts. Some small ones (such as our Doll-Baby kilns) use just 120 volts. Most non-US voltage supplies are either 220 single phase or 380 three phase. Kilns need a lot of power to run and being around that much electricity can be dangerous. Always physically disconnect what you are working on from the power supply. If it is not possible to disconnect physically, be sure to turn off the power supply and take a voltage reading to ensure there is no power on. Ideally you would be able to see the power disconnect closest to you and monitor it to make sure no one turns it on while you are working. Lock-out-tag-out padlock type devices are available if you cannot see the power disconnect. (This is required for commercial, industrial and institutional users). These allow you to lock a power supply while you are working on the kiln. Once the kiln is unplugged, all the parts are safe to handle, provided they are not too hot. See *cautions.pdf* in the CAUTIONS Section.

GENERAL INFORMATION

See *troubleshoot-electricity.pdf* in the TROUBLESHOOTING section for a good simple explanation of how electricity works in a kiln.

Making visual comparisons between circuits in the control or between sides of the same circuit will often point to the problem.

Electricity travels in a circle, hence the word “circuit”. It is easiest to visualize your kiln circuitry in terms of a circle. Electricity always chooses the easiest path, as well. It always tries to go to “ground” before anything else, but if this is not possible, it will flow into your circuit as soon as you turn the circuit breaker on. Think of the kiln elements as part of the “circle”. They are termed the (electrical) load. Everything else in the control box just provides the route for the electricity to travel on; this is termed the

GENERAL L&L KILN TROUBLESHOOTING GUIDE

(electrical) line. Like a wall receptacle in a house, the electricity just sits at the edge of your circuit breaker until you turn it on. As soon as you turn it on, the electricity will rush into the kiln circuitry, stopping at a turned-off switch, or a turned-off kiln-sitter; once you turn the switch or kiln-sitter on, then the electricity goes further, until it hits the elements. The nature of the material that the elements are made of provides a consistent amount of resistance per unit of measurement, depending on the thickness of the wire gauge and length of element wire. Good element design is complicated by the need to balance coil diameter, wire diameter, total resistance needed, stretch ratio, watt density and other variables to create an optimal design. Basically, however, the resistance provides the heat, the special alloy withstands the high temperatures, and the engineering of the kiln can maximize these and other variables by providing the correct ingredients to create the whole system.

REPLACING WIRE TERMINALS

When you replace any electrical component there will be wires with terminals on each end connecting the component to the circuit. If you just replace a component such as the switch, and not the terminals that attach the wires to the switch, your new switch may not last very long. Replacing both the "male" and the "female" parts of any electrical connection is the best way to repair it. For this you will need a good wire crimper. Do not use pliers except in an emergency repair. You must have total contact between the wire and the terminal or you will create a resistance which will heat up the terminal, wire and component and cause an eventual failure.

MANUAL KILN SWITCHBOX

L&L sectional kilns make visualizing kiln circuitry easy. K, J, JD and DaVinci models -- as well as most kilns on the market -- are all just parallel branch circuits stacked on top of each other. There is one power source coming in and it branches out into two to six (or more) branch circuits in L&L kilns. Each branch circuit has two or three elements in it and these are wired in parallel or in series. "Current proportioning" can change the element configuration from series to parallel to achieve low, medium, and high. .

They were used on the old K models and other old models, and on some newer manual kilns. Manual Davinci, Doll and Jupiter kilns, and the older Econo J kilns use "time proportioning switches" (also called Infinite or INF switches). These time proportioning switches sometimes (in smaller J Series kilns up to 15 amps per circuit) control power directly. On higher amperage models, like the J236, J245, J2900 Series and the DaVinci kilns, the switches control power contactors. These switches give the operator more control, as one may set them for low, medium or high and anything in-between. They also allow the resistance of a branch circuit to be measured easily (to diagnose element problems). There is no different resistance at low, medium or high like there is with a current proportioning switch. It will be the same reading regardless of what the switch is set for (except Off), depending, of course, on where you are reading the resistance from. (Note: our use of the phrase "current proportioning" here refers to fact that the actual wattage of the whole element circuit is changed by the switch; it does not imply the use of an industrial device known as an SCR which incrementally changes the current in a circuit).

DIAGNOSE A SLOW-FIRING MANUALLY CONTROLLED KILN & GENERAL TACTICS

Manually controlled L&Ls without electronic controllers are set up for easy measurement of resistance and voltage. Most other manually controlled kilns are set up in a similar fashion. The following steps will outline the process of diagnosing one of these kilns with, say, a slow-heating problem.

#1) Look for the nameplate data

Every kiln should have a nameplate containing model number, voltage, phase and amperage needed, as well as the watts that it will produce. This is the key and is often the only information you may have on how much power to make available when hooking the kiln up, and how the kiln should act. Plug the Amps and Volts labeled here into Ohms Law to see what the resistance for the whole kiln should be. There is a photograph of a typical nameplate later in this

GENERAL L&L KILN TROUBLESHOOTING GUIDE

troubleshooting guide.

If the nameplate is missing you can call or email the factory to try and figure out what model it is. Measure the inside dimensions of the kiln, take whatever resistance readings you can, let us know whether it has Hi-Med-Low switches on infinite type switches and describe anything else you can about the kiln. A digital picture emailed to us can be very helpful.

#2) Measure the total resistance of the kiln

Always unplug the kiln or turn off the power if you cannot unplug it when measuring resistance in these circuits. Now turn all switches to high, and turn the kiln-sitter on. Measure the ohms from the prongs on the main powercord -- from the two 'hot' blades, not from the ground or neutral. The reading should match within about 9% of what you calculated it should be from the nameplate data.

A) If there is no reading, or a reading that makes no sense like .031 ohms or any reading that has KOhms (Kor MOhms after it then;

1) The meter is not set to the correct setting or is low on batteries. Change the batteries and set it for either "auto-range", or 0-200 Ohms , or a similar setting.

2) Kilnsitter or switches are not ON (turn infinite switches to 100% on)

3) Kiln is equipped with an automatic control or there are contactors with open contacts between your measurement point and the elements.

4) There is a short to ground somewhere. Part of the circuit is in contact with ground.

5) All the elements have failed.

6) There is a break in the powercord, kiln-sitter connections or in the main power line somewhere before the point where the branch circuits begin.

7) There is a chance that different or the same components in the branch circuits could all fail at the same time. Although the chances of this happening are pretty slim, it should be considered if none of these other factors are applicable.

B) If there is a reading, it should be within 9% of what you mathematically determined from the nameplate

label. If it is not, the reading will almost always be higher than what you calculated. Only if the wrong elements were installed in the kiln - or if the elements are so old that they are squashed into each corner all the way around the kiln (old elements expand in size) - can the resistance be lower than what the nameplate calculations would indicate. Low resistance is very bad because it means more electricity is being pulled in through your components than they were designed to handle. Look for overheated connection points if this situation continues for any length of time and replace elements immediately. With a high resistance reading, you want to see how much higher it is and what the relationship between the calculated resistance and the actual resistance really means.

1) If the reading is just a bit more than 9% over the calculated resistance, the elements are probably all still connected but are badly oxidized. Check the actual voltage from where the kiln was plugged in or connected to power. Divide the resistance you have measured into that number and compare the result to the amperage on the nameplate. It will be lower. Problems can also arise if the actual voltage is considerably different than the nameplate voltage. A 240 volt kiln running on 208 volts will have about 25% less power. A 208 volt kiln running on 240 volts will burn up the elements and the switches quickly.

2) More testing is needed if the readings are considerably higher.

3) The meter is properly set but there is a considerably high ohms reading at the powercord.

C) Double check your math. Be sure that your calculated resistance for the whole kiln is a result of the nameplate voltage divided by the nameplate amperage.

D) Know the kiln's history. Were the elements just replaced? If so, check the rewiring. You will need a wiring diagram for the kiln and a switch schematic if it is a four position switch (Low, Medium, High, Off). There is also a chance that the wrong elements were installed.

#3) Measure the resistance of each branch circuit

Turn the switches OFF. The switches must be off or

GENERAL L&L KILN TROUBLESHOOTING GUIDE

else the meter will read all the branch circuits at once. What this does is reads the resistance of just the elements in each circuit, not the entire kiln. On a many L&L kilns there are plug and receptacle connections between the elements and the switches or contactors. Measure branch circuit resistance with the kiln power OFF from the two flat prongs (not the ground) of the plug-heads of each kiln section. On other kilns you want to determine how many elements are in each circuit and how the elements in each circuit connect together and to each circuit's power wires. Take the branch circuit resistance reading at the point where the power wires connect to the element(s).

#4) Determine Series or Parallel

Look to see if the elements are wired in series or in parallel with each other. Even in L&L's latest kilns you would still have to either take the element box off or look at the kiln's wiring diagram to determine this. See *troubleshoot-element.pdf* in the TROUBLESHOOTING Section.

#5) Check individual element resistance

Try to get a single element's resistance reading by either calculating it if they are in parallel or by measuring it with the meter if they are in series. You may need to disconnect wires to isolate as much as possible each element. Keep in mind that on some kilns, like our B Series kiln and many other kilns currently on the market, elements can be graded from top to bottom and may have different resistances.

#6) Take a voltage reading in each branch circuit

Do this either at the element connection to the power wires or at the control box receptacles on later L&Ls.

A) Usually a kiln with 240, 220, or 208 volts supplied to it will still have 240, 220, or 208 volts at the elements. Sometimes, though, the "240" volts will be split using a Neutral line (this comes in with the main power line in K18, and K18R kilns only. Some other kiln companies make use of this as well. Usually they would be labeled "220/110 VAC"). This happens right at the point where the branch circuits begin. By using the Neutral line, the "220" volts are split into two 110 volt circuits. When plugging each branch circuit

resistance into Ohms Law you must calculate using the actual voltage in the branch circuit, not just what the nameplate says.

B) Another reason to test the branch circuit voltage is that corroded element connections (and corroded connection points in general) will cause a slight - or not so slight - voltage loss, in the form of heat. The voltage can drop considerably as it goes through the control to the elements if there are too many corroded connection points. Measure the voltage at the main power supply. Then measure it at the element connections to the power wires. If there is a considerable voltage drop then you have a corrosion or connection problem. Kilns in general corrode easily, even the "stainless steel". Heating and cooling, baking off moisture, and all sorts of fumes and particle matter combine to create a corrosive environment. Using a down-drafting vent system combats this. Badly corroded connections need to be replaced immediately. Both parts of a connection should be replaced at the same time. It is possible to "clean up a connection" by using an emery board or a gentle file to remove corrosion. But once corrosion starts, it generates heat, which in turn generates further corrosion, and more heat, etc, - this vicious cycle will continue until you smell something awful, trip your breaker, or possibly start a fire. In particular check your plug and receptacle connections, especially the main powercord and receptacle.

#7) Add it all up

Note and compare what the whole kiln's resistance is, what the branch circuits' resistance is, what an individual element's resistance is, and whether the branch circuits' elements are wired in series or parallel. If the branch circuit voltage is different from the whole kiln's voltage supply (220/110), then it will be easier to compare the numbers of each branch circuit individually like you would for the whole kiln if the voltage was the same all the way through. Draw and label a picture of the wiring and the elements. Check yourself using the different formulas in Ohms Law.

#8) By now you have determined if the elements are the problem or if the

GENERAL L&L KILN TROUBLESHOOTING GUIDE

components or connections are the problem.

A) If this kiln had a calculated resistance of, say, 7 ohms, and an actual resistance of 8 ohms, you have determined that you need elements if none are broken and no circuits are out. The ohms are a bit more than 9% over the calculated resistance and this correlates with the problem (slow kiln), considering the fact that no circuits or elements are out. Ideally you should replace all the elements; at least replace those with readings that are too high. If you do not replace them all at once, the kiln may heat unevenly. (However, with the zoned design twith ungraded elements his is much less of a problem than with kilns that have graded elements).

B) If this kiln had a calculated resistance of, say, 7 ohms, and an actual resistance of 15 ohms, you would have to assume that either the elements are really far gone or a circuit is out. When going through the steps above you will establish (for the sake of this example) that this kiln has three equal parallel branch circuits and each branch circuit contains two elements wired in series. With a calculated resistance of 7 ohms and the knowledge that the kiln is made up of three equal parallel branch circuits, you know that each branch circuit's resistance should be 21 ohms. Because your actual resistance reading is 15 ohms, you should be able to see that the relationship between one branch circuit and 21 ohms, and three parallel branch circuits and 7 ohms ($21/3=7$), would point you to the fact that 15 ohms is about what only two branch circuits would measure; hence, one is probably not working. The extra ohm is here because nothing ever comes together that perfectly. The other elements are probably aged also, or the small percentage of error inherent in even the most precise measurements can be blamed for this extra ohm.

#9) What if the element ohms are OK?

Lets say it turns out the element ohm readings taken at the elements come up fine. However, the whole kiln resistance is 15 ohms, not 7 ohms, as it should be. The problem must be in a branch circuit because the kiln will work partially, so we know the main power wire is not the source of the problem. The element ohms are all OK, so the problem must lie somewhere between the two. To determine why a branch circuit is not working:

A) With the kiln on, run a voltage test on the receptacles or at the connections to the elements in each branch circuit to see which it is the bad one.

B) Making sure the power is off, open the control panel and visually inspect the branch circuits. Check branch fuses if the kiln has them.

C) Locate the two wires that begin the bad branch circuit from the bunch that come from L1 and L2 on the main powerblock.

D) Follow those wires to where they connect to the first component in line, probably either a fuse block, a relay or a switch.

E) With the power ON, and any kiln-sitters or switches on High (so that the elements would come on if they could), take a voltage reading at the point where these two wires connect to the first component in line. The reading normally should be the same as what it is at the main powerblock. If it is not, one of the wires between the main powerblock and the first component is bad. Replace it.

F) If there is voltage there then take another reading after the first component at the point where the two wires continue onto the next component or to the element connection. If there is voltage after the component then the component is working.

1) Note: Low/ Medium/ High switches in some L&Ls and in other kilns have three wires running from them to the element connections. With these switches on High, take your voltage reading at any two of the three connections. Take all three readings, though. (for example: the two left connections, the two right connections, and the two outside connections).

2) Note: If the component is a relay or a contactor, the switch controlling it would have to be on High for voltage to be able to be read after this component. There are contactors connected by infinite switches in all L&L manual kilns with sections that draw more than 15 amps. L&L's infinite switches can only handle up to 15 amps, so contactors must be used for larger loads. If you cannot read the voltage after a contactor even if the switch controlling it is on High and there is voltage before the contactor, the problem could be either the switch or the contactor. The

GENERAL L&L KILN TROUBLESHOOTING GUIDE

contactors L&L uses contain what is essentially an electromagnet, called a coil. The coil in the contactor completes the circuit that is being controlled by the switch. When the coil is activated by turning on the switch, it creates a magnetic field which pulls the contacts together in the contactor, allowing electricity to pass through to the elements. This allows the higher-rated contactor to handle the power to run the elements, while the lower-rated switch just handles the very minor amount of power necessary to energize the coils of the contactors.

Picture of a PRD-7AYO relay used on most J Series manual kilns that require contactors.

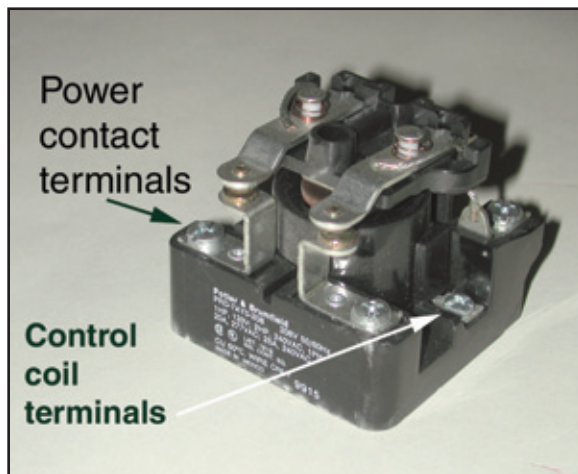

Picture of an enclosed 25 amp relay that we currently use on most Jupiter automatic kilns and some manual kilns.

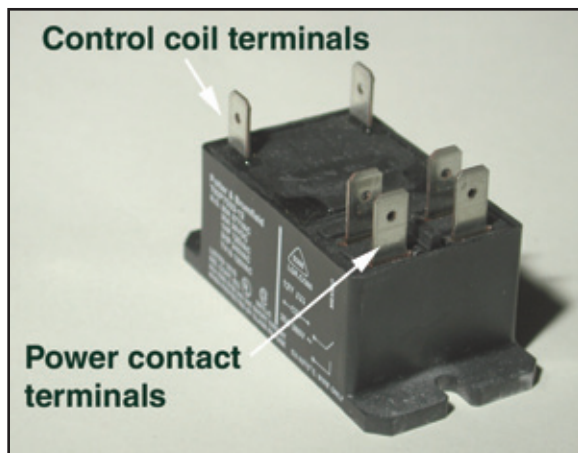

Picture of a 50 amp contactor used on DaVinci kilns.

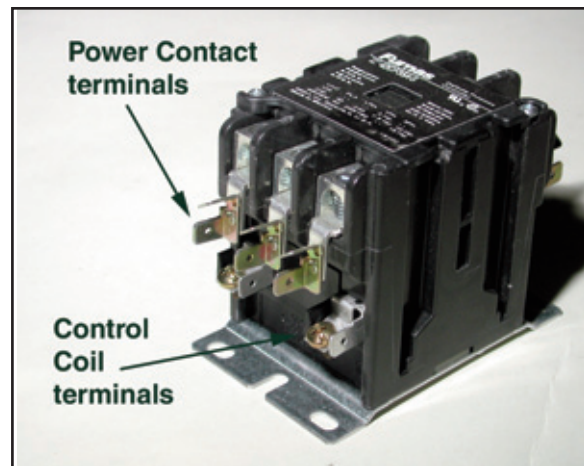

a) To determine whether the contactor or the switch is bad, first follow the wires from the load side of the switch to the contactor.

b) With the power all on and the switch on high, take a voltage reading where the two wires from the switch to the contactor connect to the contactor. Normally there will be the same voltage before the switch (on the switch's line side, or at the main powerblock) as at the test point. If these voltage readings are the same, then the contactor is bad.

c) If there is no voltage present, then follow those two wires back up to the load side of the switch and measure the voltage there. If the voltage reading is the same, then one of the wires is bad.

d) If there is no voltage present at the load side of the switch (power all on, switch on high), then be sure voltage is coming to the switch; if it is, then the switch is bad. Replace the switch and if the problem still persists then repeat the test; you will most likely have to replace the contactor as well.

e) If there is no voltage after the first component in line and it is not a relay/contactor, then just replace it. If it is a fuse holder, just replace the fuse (usually a bad fuse means there is a short somewhere in the circuit). Use a "continuity" tester to test for bad fuses. Always check tightness of connections in a questionable circuit.

f) If there is voltage after the first component then

GENERAL L&L KILN TROUBLESHOOTING GUIDE

move along the circuit from the main powerblock towards the element connections, testing for voltage before and after every component until you isolate the problem. Do not bother taking voltage readings at the element connections anywhere other than where the power wires connect to the elements. Voltage readings taken from between the elements (and from between resistors in general) give a reading that reflects voltage which is half the supply voltage with two elements in series, and either one-third or two-thirds the supply voltage with three elements in series (depending on which side of the middle element in the series the test lead is placed).

MANUAL DAWSON KILN SITTER

See the Dawson Kiln Sitter Instruction Manual in the CONTROL section of your Instruction Manual.

BASICS

L&L has used the W.P. Dawson company's kiln-sitters and sitter/timers for many years. A "kiln-sitter" is a device that incorporates spring-loaded electrical contacts coupled with a mechanical start-up and shut-off assembly. This assembly uses a long ceramic tube that extends through the wall of your kiln and protrudes about 1-1/2" into the firing chamber. A small pyrometric cone or bar is placed in the mechanism at the end of this tube in the kiln. When the pyrometric cone melts enough to bend, the mechanism moves and sets off a spring-loaded lever whose movement allows the contacts to pop apart, cutting power to either the kiln or the branch circuits' contactor coils. Timer models incorporate a timer into this assembly. The timer uses a fixed stop to essentially push the spring-loaded lever (see "How the Kiln-Sitter/Timer Works" in this manual for more information and see also the Dawson instruction manuals). Dawson models such as the model P and K have no timers and are still available from L&L. We use the model P on the automatic kilns as an optional back up safety device. The LT-3 and the LT-3K have timers in addition to the shut-off mechanism; they are now used on all L&L manually controlled kilns. The P and the K are essentially the same except the P is housed in its own metal box. The LT-3 has a 240 volt AC timer motor and the metal box to house it, and the

LT-3K has a 120 volt AC timer motor and no metal box (this is the one we use in the Doll-Baby kilns). Both the K and the LT-3K were designed to be attached directly into an existing control panel, while the P and the LT-3 mount in their own box and are connected electrically to the switch box or other control. Any of these four models can be housed in the metal box or attached directly to an existing box.

The kiln-sitters are used either as a safety backup or as the primary turn-off control.

Many people who are using manual kilns will want to pay great attention to the end of the firing. These people will be adjusting switches throughout the firing to even out the heat top to bottom, and will have self-supporting cones that can be seen through the peepholes to know at the end of the firing that all the sections are even in temperature. The kiln-sitter will turn off the kiln once its cone has melted, with no regard to the temperature in the rest of the kiln. What this means is that there is the potential for the ware in the bottom of the kiln to be under-fired if the kiln-sitter is in the top of the kiln, or over-fired if the kiln-sitter is in the bottom of the kiln. You will also be able to turn off the entire kiln yourself when you see the target cone slump over. In this scenario, you would have the kiln-sitter cone be one or two cones higher than the cone you are firing to. Of course, if you are not very fussy about the final result you can have the kiln sitter do the shut off automatically. Just be sure to be near the kiln when it is supposed to stop. Kiln Sitters are not fool-proof devices! REMEMBER: They need periodic cleaning and adjustment.

Safety Note: Unplug/ disconnect the kiln from power if you are working with it!

How the Kiln-Sitter/Timer works

A) The timer

A) The timer is a limit timer, counting down the hours you set it for until it reaches zero, at which point it turns off the kiln regardless of what is happening with the cone device. This part of the device is usually thought of as a back-up for the shut-off part. (Note: some people do not like this feature and disable it by removing the wires that power the timer motor)

GENERAL L&L KILN TROUBLESHOOTING GUIDE

B) The shut-off mechanism

This is a bit more complicated. There is a set of contacts similar to those in a power contactor except there is no electro-magnetic coil to be energized. There is a spring-loaded button with a slot cut around it on the outside of the kiln-sitter that, when pressed, pushes the electrical contacts together. This allows electricity to pass through to the elements. There is a spring-loaded, sliding, flat piece of metal that is forced into the button's slot once it is pressed in, which keeps the button from popping back out.

There is a hinged weight hanging off of the front, directly over the button. When the weight hangs all the way down, the button will not stay in when pressed because a small piece of the weight is now holding the flat piece of metal out of the buttons' slot. When you raise the weight, the button will stay in if pressed. If you raise the weight all the way up you will find it will not stay up on its own. There is a small claw-like piece at the end of a long rod which sits directly above the weight when it is in the up position. This is called the "claw" and the rod is called the "sensing rod". The sensing rod moves easily up and down and raises the claw up and down with it. When the weight is all the way up, the claw can be lowered to trap the weight under its edge; this keeps the weight up and allows the button to stay in.

CAUTION: You should not press the button in until you are ready to fire the kiln. Setting the kiln-sitter requires you to have your hands inside the kiln. If the power is on, there is a risk of electrocution with the kiln-sitter button pressed in.

CAUTION: If the power is on and there is a "fused contactor" (a condition in which a contactor has essentially failed by welding its contacts together in the intense heat of electrical arcing between dirty contacts), some or all of the elements will be on even if the kiln-sitter and all the switches are off. So be sure the power is turned off at the main disconnect or circuit breaker.

Now the weight is up, you are holding the claw down to keep the weight up, the button is out and the power is off.

There is a ceramic tube going from the back of the

kiln-sitter through the wall of the kiln, ending with an oval-shaped hole, the other end of the sensing rod and two angled, flat pieces of metal called "cone supports". In order to use this kiln-sitter, a small pyrometric cone or pyrometric bar must be slid in place here. The cone lays flat across the tops of the cone supports. The sensing rod rests in the middle, on top of the cone. When the cone is in place the weight should still be up, trapped behind the claw. The cone will melt and bend at a specific temperature (actually after a specific amount of what is known as heat-work) and there are different cones for different temperatures or different amounts of heat-work. As the cone begins to melt, the sensing rod resting on top of the cone begins to force its way down, slowly bending the cone. As the sensing rod moves down on the inside of the kiln, it is slowly moving up on the outside. The claw attached to the outside end of the sensing rod moves up and eventually the weight is freed. It falls if the kiln is level and the device is operating properly (dirt or corrosion can impinge on proper operation). In falling, it knocks the spring-loaded metal plate out of the button's slot, allowing the button to pop out, which turns off the kiln. If this does not work, the timer will run down, and the timer motor will push the spring-loaded metal plate out of the button's slot, thus turning off the kiln.

With all this cause and effect there are many ways this device could not work properly. With a maintenance schedule, though, it can work well for years. The user's manual from Dawson is excellent for maintenance and troubleshooting. Usually, the biggest problem we see is either the button not staying in or the kiln-sitter not turning off the kiln.

Potential Problems with the Dawson

A) If the button will not stay in, the weight is up, and the kiln-sitter is relatively new, there is probably a wire pressed against the spring-loaded, flat metal piece; this keeps the piece from sliding into the button's slot. Or maybe the spring has come out of its tiny hole in the flat piece of metal. If the flat piece is older, corrosion may also keep it from sliding.

B) If the kiln-sitter does not shut off the kiln but the timer does, then usually either the wrong cone was used, the weight or the claw are out of adjustment, or

GENERAL L&L KILN TROUBLESHOOTING GUIDE

the kiln is not level and the weight cannot fall once it is released.

C) If neither the kiln-sitter nor the timer shut off the kiln then either the corrosion inside is so bad that nothing moves easily, or the contacts behind the button are fused together. This can be fixed with a wire brush and some lubricant or with a new contact block, but it may be time to replace the whole Dawson kiln sitter or, at the very least, the tube assembly.

D) The tube assembly can get filled with condensed glaze residue or other debris. It may be possible to clean it out but most likely you will need to replace it.

E) The actuator rod can become so corroded that it does not work properly. This will typically require a change in the tube assembly.

FOR MORE INFORMATION

The Dawson instruction manuals have very good diagrams that are important to have.

dawson-LT3.pdf

dawson-pk.pdf

AUTOMATIC CONTROL BOX

General Information

The similarities between the automatic controls and the manual controls are most easily seen in the power circuits. Just like in a large manually-controlled kiln with contactors controlled by switches, all the automatic kilns contain contactors which are controlled by the automatic controller. Early controls just had one output which turned all the contactors (as well as the elements) on and off together. Later controls (used after September 1998) typically have 3 inputs and outputs, which allows each contactor, and the element circuit connected to it, to be turned on and off individually as needed, based on the the various inputs. (See *dynatrol-instruct-blue.pdf* in the CONTROL section of your Instruction Manual for more information on the DynaTrol).

DaVinci Control Panel. This shows branch fusing.

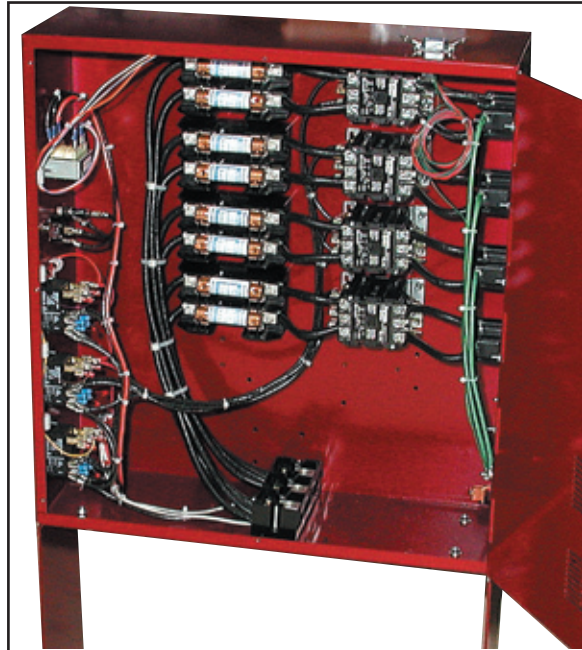

The control knows when to turn the contactors on and off because of the signals it receives from the inputs. The inputs are the thermocouples (TCs), also known as the temperature sensors. In early controls only one TC was used. The micro-processor (the brain) in the control compared the TC reading to the map of the programmed firing it was following and decided whether to activate the output to turn on all the elements or not. The later versions of these controls, like our DynaTrol, have three of these thermocouples inputs. Each is connected to its own part of the processor and has its own separate output.

The thermocouples are meant to be positioned in the wall of the kiln near the middle of the zone whose temperature they are reading; the tips should be about 1" to 1-1/2" in. A zone is the area in a kiln controlled by just one of the controllers outputs. For example, a model JD230 has three zones, each controlled by one of the three main outputs. In its control panel there are three branch circuits, each containing a contactor. Branch circuit number one's contactor is controlled by output number one from the DynaTrol controller. Output number one comes on or off depending on readings from thermocouple number one (input number 1), which is located in the top (#1) section of the kiln. The electricity in branch circuit number one

GENERAL L&L KILN TROUBLESHOOTING GUIDE

feeds the elements in the top section (number one zone). Number two zone is the middle section and number three zone is the bottom section; each is individually controlled by their respective contactors and thermocouples. Essentially, each zone is like its own kiln, with its own temperature sensor and power supply. When stacked on top of each other the zones operate independently, yet they all follow the same path and more or less do the same thing by comparing the actual temperature in each zone to what is on the program map and then either leaving the elements on or turning them off accordingly. The DynaTrol computer-controlled kilns use calculations to determine some functions. These calculations are performed in the micro-processor with data fed from:

A) your choices in programming; B) the thermocouples; C) the internal clock. The various calculations performed throughout the firing result in the complex firing programs, uniformity and the consistent automatic shut-off or controlled cooldown.

A) Your choices in programming fill in the blanks on the map of the firing (i.e. how fast the kiln will climb in temperature and to what temperature, if there is a hold, a preheat, a delay, etc). The Easy Fire programs have most of these settings pre-programmed. The Vary Fire programs can be completely programmed and altered as you wish.

B) The thermocouples measure the temperature in the kiln by emitting a specific linear millivolt signal for each degree of temperature. The microprocessor equates this millivolt signal to a specific temperature in °F or °C. The location of each thermocouple is important because the signal emitted will reflect the temperature in that part of the kiln. The DynaTrol takes these signals (typically one from the top zone in the kiln, one from the middle zone, and one from the bottom zone) and compares each in turn to the “process variable” or “setpoint”. This is the temperature that the kiln is supposed to be at any particular point in the firing program. This “point in time” is constantly being modified as time passes. Based on where the firing map says the kiln should be, the appropriate corresponding outputs to the TC inputs are activated. In other words, when each TC reading is compared to the firing map, a decision is made by the micro-processor to either turn on the elements in

that particular thermocouple's section, or to turn them off. In this way, the kiln temperature closely follows the programmed rises, holds and ramp-downs.

C) The internal clock is really never seen except when the control is counting down hours and minutes during a hold time, a preheat or a delayed start. However, its information is used in nearly every calculation.

D) The Orton Firing Institute has devised and patented a way to calculate a final temperature for a firing, based on the relationship between how many degrees the kiln is climbing per hour, and what temperature is presently in the kiln. This calculated final set point temperature is the temperature at which the pyrometric cone that the firing has been programmed to go to will melt, given that specific rate of climb and current temperature. Near the end of firing, the DynaTrol slows the kiln's rate of climb down proportionally in order to avoid an overshoot. This means that the calculated final temperature is constantly being adjusted at the end of the firing to account for the slowing down of the kiln. This is only used in the “Easy-Fire” mode. It is an elegant way for the control to measure heat-work that is so important for ceramic firing and consistently and accurately fire correctly even given different loading conditions and the changing character of the kiln itself.

Needless to say, these controllers are more complicated than the older infinite or Hi-Medium-Low switches. In order to properly control the kiln, they also need a lot of self-diagnostics. If a thermocouple is burned out there needs to be a way to alert the user. If the kiln is climbing so slowly that the calculations reach an impossible scenario, there must also be a way to alert the user. All the error codes are explained in Appendix G of the DynaTrol Instructions (*dynatrol-instruct-blue.pdf*). They all refer to a specific situation, but the reasons that the situation exists is often due to more than one different cause.

E) Calibrating the control: See the section on calibrating the control in *basic-dynatrol.pdf* in the OPERATION section of your Instruction Manual. There is a good explanation of the thermocouple offsets and how to change them.

GENERAL L&L KILN TROUBLESHOOTING GUIDE

This is a handheld DynaTrol control - standard on the DaVinci automatic kilns. Normally the DynaTrol is directly mounted in the control box of a Jupiter kiln. This handheld box plugs into a special receptical mounted on the top of the DaVinci control box or on the front of the special optional Jupiter control box. There is a 6 foot cable and typically it is hung on a hook on the wall.



Diagnosing Error Messages

Error codes can appear at any time during the firing. They always refer to a problem that, if allowed to continue, could end with unknown or even disastrous results. **Errd**, **Err1**, **ErrP** and the **FAIL** message seem to make the most frequent appearances. **Errd** means there is a temperature difference of more than 100 degrees between the zones. **Err1** indicates that the kiln is climbing too slowly in an Easy-Fire program to calculate what the final temperature should be, based on what cone you have programmed it to fire to. **ErrP** indicates that there was either a very quick power outage (**ErrP** will flash along with the temperature and the kiln will still be heating), or there was a longer power outage (**ErrP** will be the only thing in the display and the kiln will not be heating). **FAIL** refers to a specific thermocouple failure. It will appear after displaying a “tC” (thermocouple) number 1, 2 or 3.

Can you restart the kiln?

You can try to restart the kiln after getting an error code. Some messages, like flashing **ErrP** and **FAIL**, will not necessarily turn off the kiln. Depending on the problem though, re-starting it may or may not let it finish the firing, or even start up again. An **Errd** will usually not re-start easily because the temperature top to bottom is drastically different. An **Err1** at the end of the firing will re-start but will probably re-occur in about 22 minutes. A **FAIL** message will not go away even if the problem is fixed during the firing. The kiln can still be firing with the **FAIL** message flashing along with the number of the TC that failed. Stopping and then re-starting the kiln after fixing the problem with the TC circuit is the only way to erase the **FAIL** message. **ErrP** flashing with the temperature means that the kiln is still firing, after just a short power outage or interference. Just press any number to clear the **ErrP**. An **ErrP** which is not flashing must be re-started.

Worst Case Scenario for Restarting After an Error Code

Keep in mind that you run the risk of over-firing if you re-start while the kiln is very close to the final temperature. A pyrometric cone melts with the proper combination of time and temperature. Add more time and you don't need as high a temperature, go to a higher temperature and you don't need as much time. When an error code shuts down the kiln near your final temperature (within about 50 degrees) and you do not know exactly how long it has been cooling, or what temperature it reached before the error code appeared, you run the risk of having too much unaccounted for time in your time-temperature equation. The DynaTrol calculates this equation automatically after determining how many degrees per hour the kiln is climbing (time) and to what temperature it is climbing to (temperature). However, it cannot do this accurately after a high temperature re-start.

If you have cones in the kiln that you can see through the peepholes, then use these after you re-start and turn off the kiln manually when the target cone bends over.

If you do not have cones visible then you can gamble

GENERAL L&L KILN TROUBLESHOOTING GUIDE

and estimate a final temperature based on how many degrees per hour the kiln has risen, including the time it was off.

For example, you come in and the control says tC 2, 2200 (degrees F) and everything seems fine in your slow glaze to cone 6 firing. But twenty-five minutes later you come back and see Err1.

The first thing you want to do is press #1 to clear the error code. Look for tC 2's temperature and write it down. It might be 2175. You have no cones in the kiln but you really need these pieces fired.

Wait a few seconds until you see "**IdLE, tC 2, 2175**". Press Start to re-start the program and note the time on your watch. Note the 25 minutes the kiln was "holding" from the last time you saw it at 2200°F until this time, where it says **2175**. It must have continued to climb somewhat, but because the **Err1** will appear after 22.5 minutes of holding when the kiln is programmed to be climbing, it probably never got over 2210°F. So the kiln has held at an average of about 2195°F for about 25 minutes, instead of continuing on to 2232°F (cone 6) to finish the firing.

The relationship between time and temperature allows you to estimate how much hold time to add to get the same amount of heat work as the kiln would have achieved by climbing to 2232°F. Assuming a 108°F per hour temperature rise, a good rule of thumb is to add about a 20 minute hold to the maximum temperature; this will allow you to lower the final temperature by about 20°F. An hour hold time would mean a final temperature of about 40°F lower. A two hour hold time would be about 60°F lower. (This same information and more about time and temperature is in the section on pyrometric cones)

In this example, the kiln has already held at about 35 degrees lower than the final temperature for 25 minutes. It would need another 25 minutes of holding to give the ware the same amount of heat work that 2232°F (cone 6) would have.

In reality, however, an **Err1** that close to the end of a firing probably means you need new elements. So re-starting the kiln will probably not enable it to climb much higher in temperature. Keeping track of the time, let it run, and when it shows **Err1** again just

keep re-starting it until the firing finishes. Meanwhile call and order new elements.

Be very careful if you try this method. On loads that are very important always use cones you can see through the peepholes in case of a failure of some kind. If you have to use this method without the cones, remember that almost all your calculations are based on estimates and the results could be disastrous to your ware and/or the kiln if you are not accurate enough. The further away the temperature that the kiln is holding at is from the cone that the firing was trying to get to, the less accurate an estimated amount of time will be to achieve the amount of heat work necessary. If you can wait and re-fire from room temperature, you should. If you depend in any way on your kiln you should keep spare parts around for it. You could replace the elements easily yourself after the kiln cools and then re-load it and re-fire it to the proper cone without losing much time at all. Or consider that most glazes have an entire cone's temperature range that they can mature within. Weigh your options and decide.

In general though, Error Codes mostly appear after the kiln has been disassembled and set back up improperly, has had its power supply altered (like moving to a new studio with different voltage), or has had an element or a thermocouple burn out.

Errd

If the kiln was just re-assembled and **Errd** is the error code, then double-check that the kiln sections are plugged into their appropriate receptacles and the thermocouples are in the proper zones:

-Two section kilns: Top ring is in #1 receptacle on the control, bottom is in #2. Top ring gets TC1, bottom ring gets TC2.

-Three section kilns: Top is in #1 receptacle, middle is in #2, bottom is in #3. Top ring gets TC1, middle ring gets TC2, bottom ring gets TC3.

-Four section kilns: Top is in #1 receptacle, next section down is in #3, next is in #4, the bottom is in #5 (the cords and numbers go 1,2,3,4, but the second receptacle down on the control box is skipped; there are five circuits on the control, but only four sections.

GENERAL L&L KILN TROUBLESHOOTING GUIDE

The top ring gets TC1. Either the upper-middle or the lower-middle section can have TC2 in it. The bottom ring gets TC3. All five circuit controls have the center three circuits tied into TC2. Therefore, skipping #2 receptacle with the four ring kilns would be the same as skipping the #3 or the #4 receptacle. TC1 must always be in the top section and TC 3 must always be in the bottom section. TC2 can be in either of the middle sections.

-Five section kilns: Top is in #1 receptacle, upper-middle is in #2, middle is in #3, bottom-middle is in #4, bottom is in #5 receptacle. The top ring has TC1 in it. The middle ring has TC2 in it (receptacles #2,#3,#4 go on and off together), the bottom ring has TC3 in it.

If you are sure the kiln is set up properly, nothing is out of place and none of the thermocouples are partially out of the kiln, then one of the following situations may apply:

-You were firing with the lid open and you got Errd either while the lid was open or right after you closed it. For drying with the lid open, only about two inches is needed to adequately vent off water vapor. This is plenty if all the peep holes are open. The DynaTrol will attempt to compensate for the heat loss, and it usually can. The trouble may happen when you close the lid. The elements in the top of the kiln are already much hotter than the ones nearer the bottom due to their need to compensate for the heat loss from the top. When you close the lid it can take as long as eight seconds for the DynaTrol to respond to the rise in temperature in the top of the kiln, and shut off those elements. This can quickly cause an uneven temperature in the kiln, which will usually result in **Errd** (possibly an **Err2** in a smaller kiln -**Err2** is when the entire kiln temperature is more than 50°F over the hold time's temperature for longer than 18 seconds).

-There was a lot of air being exhausted from your kiln when **Errd** appeared. If a vent system pulls too much air from just one point in the kiln, say, to down-ramp the load very quickly to a lower hold time for crystal formation, an uneven temperature can result. The firing will go slowly as it will be difficult to compensate for the heat loss; eventually, however, the

Errd (or **Err1**) can appear.

-**Errd** just appeared, the middle TC reads about 130°F lower than the other TCs. In order of most likely to least likely;

1) Something is too close to, or is touching, TC2 in the kiln. Allow almost an inch between everything for thermal expansion. Fix and re-fire the kiln.

2) A TC wire has melted against the kiln case (the yellow TC lead wire can melt and send weird signals to the DynaTrol). The wire must be replaced, which is cheap and easy to do.

3) A TC is about to fail. Perform a physical inspection if possible, or just re-start the kiln and monitor it carefully.

4) Element(s) just burned out. Perform an ohms test for more information.

5) A relay has just failed. Perform a voltage test.

6) There is a bad connection point somewhere. This will become more of a possibility as the kiln ages. Examine all points carefully for melting, corrosion, discoloration and/or bad smell.

Err1

If **Err1** is the error code on the screen when you check on the firing, then for some reason the kiln could not generate enough heat to counter the heat loss. If the kiln can get no hotter (even though all the elements appear to be on and the program is not holding), then **Err1** is what you will see. If one of the elements or one of the circuits in the control fails while the kiln is at a high enough temperature then it will probably display an **Err8** code (which means temperature is falling when it should be rising) **Err1** or **Err8** can mean either you need new elements or a new component in one of the circuits. An ohms test and a voltage test can tell you which it is. If you recently changed locations, power supplies, elements, or did any repairs, then closely examine what changed between your last successful firing and this one. There may be some other issue besides bad elements or a bad component.

-A new location can mean a 208 volt power supply rather than a 240 volt supply (about 25% less power).

GENERAL L&L KILN TROUBLESHOOTING GUIDE

-In re-wiring the power supply you may not have used thick enough copper wire (line, conduit and connection points will be very hot).

-The elements you got from some other supplier who said "these'll work fine" have too much resistance, or you did not hook them up properly (leaving the jumper wire out of a J230 section will double the resistance in that circuit and only one of the two elements will be used. Always use an ohms meter on the element and on the circuit)

-If you rewire anything improperly or incorrectly the potential for anything from a blown breaker to just no power at all is possible. (Using wire with a temperature rating of less than 150°F can seriously limit the life of the circuitry and can be dangerous as well, especially when the wires are close to the kiln. Use a wire diagram and trace every wire to check yourself). You can buy high temperature wire from L&L.

FAIL

If, upon inspection, the error code **FAIL** turns out to be a burned out TC then the solution is simple. Change the thermocouple. You should not mix unsheathed thermocouples with sheathed ones. (because their response rates are slightly different). A spare on hand is a good idea as well.

Sometimes the code **CPLt** will be displayed. This code is always displayed after a successful firing to mean "complete". If it appears after you attempt to re-start the kiln after a **FAIL** message, or at any other time except for the end of the firing to mean "complete", then it will have a different meaning. If **CPLt** appears randomly it means either your TC wires are burning against the kiln case or your TCs are so close to failing that they are giving a reading that is so high that the DynaTrol thinks the firing is over.

If the TCs are not bad (you just replaced them and they worked fine for at least one complete firing) but the **FAIL** message still appears, it may be that the TC wire is bad (melted or broken at a point) or the electronics have partially failed. If you are not electrically inclined then call the factory and send the entire control panel in for service. If you are electrically inclined then try the following:

A) Turn OFF the power, unplug or (if it is hardwired) turn the breaker off.

B) Open the cover of the control. On controls without hinged cover plates you want to loosen the TC clamp on the bottom or side of the control to give the TC wires inside some slack.

C) Number the TC wires inside so you will know which sets of screws they attach to. Then remove the TC wires from the TC connections on the electronic board.

D) In their place put tiny jumper wires. A paper clip cut into three "U" shaped pieces works well. Insert one "U" per TC circuit tightening the screws down as you go. You are simply completing each TC circuit without using the TC wire or the TC. Do not let the "U"s touch anything other than the TC connection points. Note: the fact that a paperclip is not the proper type of metal to use in a Type K TC circuit is not an issue for a test like this.

E) Cover (with electrical tape) the loose TC wires so they will not short anything out if they touch connection points and carefully close up the control.

F) Turn the unit on. If it still says **FAIL** then the electronic board has failed. If it reads room temperature then the TC wire or the TC has failed.

G) If it reads room temperature with these jumpers in, and you are not sure if it is the TC or the TC wire, just re-attach TC2's wire to TC3 and re-attach TC3's wire to TC2. If the **FAIL** message is still on TC2 then it is the wire, not the TC. If it says that the **FAIL** is now at TC3, then you know it is the TC, not the wire (there are many other ways to determine this as well).

There are many other trouble scenarios that are unique to computerized kilns. Understanding how the DynaTrol and other controls work will give the user some insight into why there is a problem. Two major trouble scenarios and their solutions are as follows:

No display (power) at all, even after 15 seconds.

1) Turn on any other control devices like switches to HIGH, Kiln-sitters ON, limit timers ON.

GENERAL L&L KILN TROUBLESHOOTING GUIDE

- 2) On SQ and some G models, and on a few custom L&Ls check the operation of the open door shut-off switch. Re-form the flexible metal trip bar if necessary.
- 3) Examine the electrical cord and its connection points coming to the kiln. Look for burned or melted areas and breaks or pinched sections.
- 4) Reset the your circuit breaker in your house, studio or factory.
- 5) Make sure toggle switch is ON.
- 6) Check the control fuse next to the toggle switch. Turn power off, push the knob in and then turn it to remove the fuse.
- 7) If none of these possibilities fixes it then there is definitely a problem. Test for voltage at the main power supply as close to the kiln as possible.
- 8) Unplug or disconnect the kiln from power.
- 9) Open the control, check for potential short circuits because the front is hanging open and then carefully apply power to the control.
- 10) Locate the control circuit transformer and measure the voltage at the two bottom, outside terminals for 208/240 vac kilns, and at the two bottom left, or bottom right for 110/120 vac kilns. Look for either the 208/240 power supply or the 110/120 power supply.

Picture of typical control transformer showing what voltages you should see at various contacts.

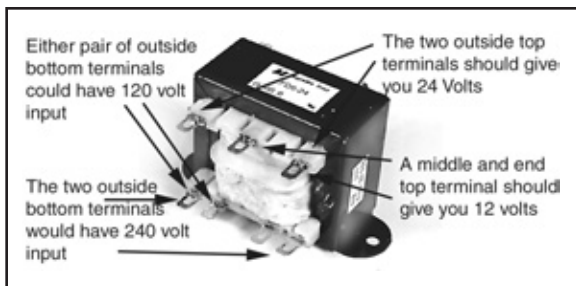

Note: If there is no voltage there, then test for it at the Power Connection Block where the power cord comes in. If there is power there then look for a bad connection or wire between the power connection block and the transformer, i.e. a bad toggle switch,

wire, or ½ amp fuse holder. If power is not there then go further back on the line and measure the voltage. Keep going until you find voltage, then look for the problem between that point with the voltage and the last point checked that had no voltage.

11) There probably will be voltage at the bottom of the transformer, so test for voltage at the top two outside terminals of the transformer. On L&L THP and DynaTrol controls the voltage here should be about 21 to 25 vac (older units that used the Perfectfire control will have transformer readings of about 12 vac because they use a different type of transformer). Look for half of the 21 to 25 vac with one test lead on the top center terminal of the transformer. Test both outer terminals with the center terminal. The DynaTrol will still work with one of these two 10.5 to 12.5 vac circuits not working, but keeping an extra transformer on hand will be a good idea. Probably there will be no voltage at the top here. Usually, if everything else (including the power) is OK then the transformer is at fault. There may be a broken or loose wire that connects from the transformer windings to the connection points on the transformer. You can try to resolder it. However, it is usually easier to just replace the transformer.

11) If there is the proper voltage at the top of the transformer then follow the wires from the top of the transformer to the DynaTrol. To eliminate the wires as culprits, take another voltage reading the same way as before, just at the other end of the same wires. If there is still voltage, but still no display, then the DynaTrol board itself is bad. If the unit is still under warranty for service or replacement, then contact L&L. If the unit is older you can still have it repaired or replaced by L&L.

Seems like the kiln is under-firing or over-firing slightly

See *troubleshoot-cone.pdf* in the TROUBLESHOOTING section of your Instruction Manual.

Calibrating the DynaTrol

See the section on calibrating the control in *basic-dynatrol.pdf* in the OPERATION section of your Instruction Manual. There is a good explanation of the thermocouple offsets and how to change them.

GENERAL L&L KILN TROUBLESHOOTING GUIDE

Stalling caused by shorting of thermocouples

L&Ls JD and DaVinci computer-controlled kilns have the thermocouple(s) mounted away from the control, making them simple to replace. The downside to this arrangement is that TC wire must be used to route the signals from the TCs to the DynaTrol. These wires will melt and fail if allowed to touch the kiln case when it is hot. The result of this is that the kiln can “stall out”, say **CPLt** prematurely or display any other number of other random error codes. It may refuse to increase in temperature, and the kiln will just run on and on. If it is re-started it may work fine for a while. What happens is that the millivolt signal in the TC wire goes to ground, or the two wires in the TC wire are “electrically” connected by the stainless steel melting through the insulation and the “temperature” is then taken right there, not in the kiln. However, the signal received can be so foreign to the microprocessor that the kiln will just stall. You can cut out the bad section in the wire and crimp or solder the wires together (making sure red goes to red and yellow to yellow) as a temporary fix. Note that thermocouples close to end of their useful life can cause some of these same problems.

Prevention and education is the best way to keep this possibility to a minimum. The yellow wires come zip-tied and more can be used to keep them away from the side of the kiln. It is not recommended to tie them to the kiln powercords or any wires carrying higher voltage. The magnetic field in high voltage wires can transmit voltages into the thermocouple wires if they run parallel next to the high voltage wires. The problem will not happen as long as everyone who uses the kiln understands about the TC wires. It may be good to keep some wire on hand just in case.

Note: Sometimes excessive ambient temperatures (over 125°F) around the control can cause stalling too. Corroded connection points can also cause stalling.

PYROMETERS

Pyrometers are very useful for monitoring manually fired kilns. L&L used to sell only analog pyrometers (now we sell only digital pyrometers). An analog pyrometer has a needle and a printed scale under the needle to interpret the needle's position. Most clay and glazes will mature over at least two cone numbers and these pyrometers are at least that accurate. In time however, they lose their accuracy. They can be calibrated by using a large cone visible in the kiln. Compare the pyrometer reading when the cone melts to a cone table temperature equivalent for that cone number and adjust the calibration screw on the front of the pyrometer accordingly. We now only sell digital pyrometers now because of their superior accuracy.

Picture of an older Tru-View Pyrometer system. All new pyrometers sold are digital because of their greater accuracy.



Tru-View Pyrometer System

L&L's TRU-VIEW pyrometer systems can have as many as five thermocouples connected to them. The pyrometer can only read one at a time, though, so a thermocouple selector switch is wired into the yellow side of the TC circuits. The TC selector switch that was originally used was replaced by the one currently in use. The new one is a simple 12 position switch. The trick when working on these is to use a continuity tester to match the lead in question on the inside to the position of the knob on the outside. For example, the knob may point to “TC 1” on the label. On the inside there is only one lead from the switch that corresponds to TC 1. If you do not connect that lead to TC

GENERAL L&L KILN TROUBLESHOOTING GUIDE

1, then when the knob points to “TC 1” on the label it may be reading some other TC besides TC 1. Note: the common wire comes from the center of the switch. See *truvew-instruct.pdf* for more information.

THERMOCOUPLES

The pyrometers and all of the electronic kiln controllers for L&L kilns work with a “Type K Thermocouple”. (Although we do make available a Type S platinum thermocouple. See *stc.pdf*). There are all different “types” in the entire range of thermocouples available to the consumer and to industry. Type K is just one type covering the temperature scale from 32°F to 2500°F (0°C to 1372°C). Type K thermocouple circuits are made of one kind of wire on one side of the circuit, and another kind of wire on the other side of the circuit. The point at which the two kinds of wire meet is right at the end of the sensor - the thermocouple probe's tip in the kiln. This is where the temperature is read. All types of thermocouple circuits are set up this way, with two dissimilar metals making up each half of the circuit. In the case of the Type K the metals are called Alumel and Chromel. They are usually either 14 awg (American wire gauge) or the thicker 8 awg wire. The thickness of the wire is only important inside the kiln. Thicker wire lasts longer, but is more expensive and more difficult to work with. Our standard Type K thermocouples in the Easy-fire, Jupiter, DaVinci and Doll kilns now come with a ceramic thermocouple protection tube. (These last longer because they are protected from the kiln atmosphere).

An 8 gauge Type K thermocouple next to a ceramic protection tube:

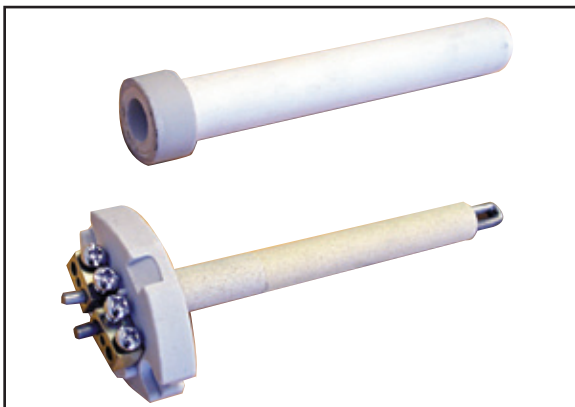

Metal Sheathed Type K Thermocouples

These have a metallic sheath on the outside of the thermocouple and are 1/4” OD. See *tc-metallic.pdf* for more information on these. If you retrofit these into a kiln with larger diameter thermocouples be sure to plug up the larger hole around the thermocouple especially if a venting system is in use. Otherwise they could read cooler than the real temperature of the kiln and this could result in a disastrous firing.

Type S Platinum thermocouples

Type S thermocouples are also available with the DynaTrol. This option must normally be ordered with the kiln as the millivolt signals from a Type S thermocouple are different than the millivolt signals from a Type K thermocouple and the DynaTrol must be pre-programmed to recognize the different signals.

A Type S thermocouple will last considerably longer than a Type K thermocouple. However, it does cost considerably more money to replace it when it does fail or break. The dissimilar metals that make up a Type S are Platinum/Rhodium and Platinum. It is these precious metals that makes the type S thermocouple cost so much more.

Over time the difference in the money spent using Type K vs. Type S is negligible. Type K will burn out faster than Type S but they are inexpensive to replace. Performance of one over the other is not an issue (except that the Type S will not drift as much when the kiln is fired to high temperatures). See *stc.pdf* for more information.

For More Information on Thermocouples

ktc.pdf
ktc-14 gauge.pdf
stc.pdf
tc-metallic.pdf
tc-protect.pdf

Thermocouple extension wire

From the TC to the pyrometer there is insulated Type K thermocouple wire containing one very thin alumel wire, one very thin chromel wire and usually an uninsulated ground wire with aluminum foil wrapping the three wires together with the thicker plastic type insulation over that. The entire circuit needs to keep

GENERAL L&L KILN TROUBLESHOOTING GUIDE

this same type of wire from the pyrometer to the thermocouple. There can be no sections containing other types of wire (like copper, or alumel where chromel should be). There is a polarity as well. The chromel side is generally referred to with the color yellow and a "+" positive designation. The alumel side is referred to with the color red and a "-" negative designation. If the polarity is reversed the pyrometer will read in reverse -temperatures will decrease when they should be increasing. Accidentally doing this will not damage anything if the problem is fixed promptly. Note that we use a special high temperature TC extension wire inside the Easy-Fire control cabinet.

Cones measure heat-work

Cones are not temperature measuring devices. They measure how much heat has been absorbed by the ware in the kiln, which is the result of the combination of time and temperature. A particular piece of clay needs a certain amount of time at a specific temperature to properly fire it, lower temperature if the time is longer, higher temperature if the time is shorter. An example of this would be if you added about a 20 minute hold to the maximum temperature of a cone 6 firing, you would be able to lower that final temperature by about 20°F. An hour hold time would mean a final temperature of about 40°F lower. A two hour hold time, about 60°F lower.

See *troubleshoot-cones.pdf* in the LOG, CONES, TIPS Section of your Instruction Manual.

THE POWER SUPPLY

This consists of the main power cord, receptacle, powerblock, wire, and breakers.

Safety Warnings

NOTE: If you are not sure about some part or procedure in creating or testing a power supply line for a kiln, DO NOT GUESS! If you wire something improperly, you might just blow the circuit breaker, or burn the place down. Get an electrician or someone who knows.

NOTE: There are many different ratings on the wire and components that make up the supply line that

need to be considered (along with proper and safe installation) when creating or testing a kiln power supply. It is beyond the scope of this manual to properly educate someone to fully understand the potential variations and variables involved in this. Often a building like a school or a recreation facility (or even a home) will be inspected for electrical code and fire code enforcement. If you do not own the building, or if the kiln is in anything other than a free standing private workshop for yourself, get permission to do what you want to do from the owner and get an electrician to properly wire the circuit so you are not liable.

The Data Nameplate

A typical data nameplate:



Every kiln has a data nameplate, usually a sticker on the side of the control box, that specifies model number, serial number, voltage required, phase required, amperage required, watts produced and the recommended maximum temperature. This is the information to get from L&L for your particular kiln if you do have not received it yet or if it has no data nameplate. If you have the information from the data nameplate, then that is what you show to your electrician, or use to procure the proper wire and components to create the power supply line. Here are some things to keep in mind if you are the "electrician":

If you are the electrician:

-As of January 2001, National Electric Code Handbook says that a resistive heater this size, on for more than three hours at a time, should be provided a circuit that is rated for 125% of the total amperage

GENERAL L&L KILN TROUBLESHOOTING GUIDE

drawn by the unit when it is on High. So a kiln drawing 43.98 amps would require a service of no less than 54.98 amps. As wire and components for power supply lines are usually rated in increments of 10, the next higher rating is 60 amps. Therefore everything in the line must be rated at least for 60 amps.

Note about the 50 amp power cord used on kilns with up to 48 amps: the cord is built to take at least 60 amps, (6AWG wire for the hot leads - good per NEC table 310-16, 8 AWg for the ground, plus oversize copper blades on the plug, and high temp. rating.) In addition this configuration has been examined by UL and approved for use not only with L&L kilns but most other UL listed kilns on the market. Do size the rest of the circuit for 60 amps (i.e. the wires, circuit breaker, etc.).

-Most L&L kilns require a specific voltage to operate properly. The Data Nameplate will say in the voltage column either 120, 208, 220, 220/110, 240, 380/220, or 480. Most of the USA is residential- 240 vac, with schools and industry- sometimes having 208 vac. Often, however, residential can be 208 (downtown NYC, south-central Idaho etc). There are usually no issues with 120 volts. 220 and 380/220 are usually found overseas. 480 is sometimes available for schools or industry. The biggest problem we see is the issue of 208 vs. 240: The kiln that says 208 volts will overheat the elements and burn them out quickly if it is run on 240 volts. Older 208 volt kilns have 208 volt switches also. They will burn out quickly if run on 240 volts. If the kiln is made for 240 volts then it will have about 25% less power and a maximum temperature of about cone 5 (maybe) if run on 208 volts. You should only run a kiln on the voltage that the Data Nameplate specifies if you are to expect the best results. Plus or minus six or seven volts is OK, but keep in mind that the higher the actual voltage is over the recommended voltage, the higher the surface temperature of the element is at any given time, and therefore it is more likely to burn out early. Likewise, the lower the actual voltage is below the specified voltage, the lower the maximum temperature will be.

Voltage is specific to the building and to time of day. It will probably be a bit lower during the day, and higher at night. You can carefully test it to see what it is with your multi-meter. It is costly to change the

voltage, but this can be done with a transformer. You'll definitely need a good electrician, though. The cheapest way to fix the problem is to replace the elements (and possibly the switches) with the proper voltage ones. The switches are marked INF 240, INF 208, INF 120 or something similar. You will probably need to remove one to see the markings. The computerized controls will work on either 208 or 240 unless 120, 380/220 or 480 is specified. (Note that we use 240 volt INF switches now on 240 and 208 volt kilns. 208 volt INF switches have slightly different timing because of the way the voltage affects the internal heater in the switch).

Use copper wire

Always use copper wire with the highest temperature-rated insulation you can find. 150°C is what the internal wiring up next to the kiln is rated for, so hook-up wire with that rating would be excellent; however, 105°C is adequate. Note: our power cords, which are approved by UL, are rated for 105°C. Keep in mind that for different amperage services, different thickness of copper hook-up wire is required. The following chart should give an idea of what is necessary:

Chart of wire and amperage

Service required	Gauge of wire required (american wire gauge)
15 amp	14 awg copper
20 amp	12 awg copper
30 amp	10 awg copper
40 amp	8 awg copper
60 amp	6 awg copper
70 amp	4 awg copper
80 amp	3 awg copper
90 amp	2 awg copper
100 amp	1 awg copper
125 amp	1/0 awg copper
150 amp	2/0 awg copper
175 amp	4/0 awg copper

GENERAL L&L KILN TROUBLESHOOTING GUIDE

200 amp	250mcm copper (1000 circular mils)
225 amp	350mcm copper
250 amp	350mcm copper

Voltage is not really an issue here. Usually wire like this is rated for at least 300vac if not 600vac. Look for the wire specifications on the insulation or ask the supplier to be sure. The voltage rating is based on the electrical resistance of the wire insulation (to prevent voltage leak).

Voltage Drop over distance

Running power for your kiln over a long distance will result in a drop in voltage. The amount is about:

7 volts per 100 feet with 10 awg wire
21 volts per 300 feet with 10 awg wire
6 volts per 100 feet with 6 awg wire
18 volts per 300 feet with 6 awg wire
3 volts per 100 feet with 1 awg wire
9 volts per 300 feet with 1 awg wire

These estimates are dependent on the kiln operating at 50% to 100% of its capacity, with the temperature of the wire no more than 167°F. Be sure to test the voltage before the run has been installed so you know what you are working with.

Power cords

The industry name for the supplied power cord on many L&L kilns is: Nema 6-50P for all single phase 208, 220, and 240 models drawing less than 50 amps. A few exceptions are the later G models (GD, GT, GQ, and GS) with the 30 amp, four-prong plug. This is a Nema 14-30P plug. The Doll kilns and other 120 vac kilns use Nema 5-15P plugs for up to 15 amps, and Nema 5-20P plugs for 15 to 20 amps. The three phase Easy-fire kilns use a 15-50P cord. Various types of 30 amp plugs are used on the Libery-Belle kilns. To get the appropriate receptacle just substitute the "P" at the end of the Nema code for an "R". P for plug, R for receptacle.

Diagram of a NEMA 6-50 receptical. The hole shown at the top is the ground.

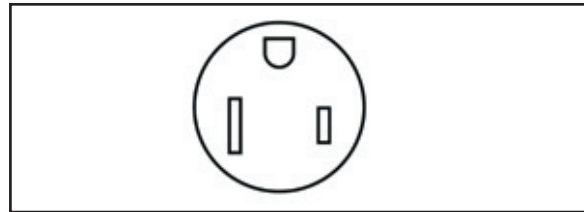

TROUBLESHOOTING AN EXISTING POWER SUPPLY

Circuit breakers

Circuit breakers that have tripped and have been reset continually will be more apt to trip at a lower amperage than they are rated for. They get worn out. Also, a breaker in a small kiln room will trip sooner because of the higher ambient temperature. An inductive amp meter will indicate whether the kiln is pulling more amperage than the breaker allows. Remember to size it for 125% of the total amp load.

Wire size too small

Using a wire size that is too small for the amperage draw will cause the wire and conduit to heat up and either the voltage to the kiln will drop (some voltage will be lost in heat) or the breaker will trip from the local heat. Without a properly sized breaker, the connection points will start to corrode and this may cause an electrical fire.

Corrosion

Any visible corrosion - especially on a plug and receptacle connection - will result in heat generated at that point. Heat leads to corrosion, which leads to more heat and eventually the melting of the component or connection point. This could start a fire if the breaker fails to trip.

Dedicated circuit

The kiln should be on its own circuit. If anything else is on the circuit the voltage will drop when the other device is turned on. The circuit breaker must be rated for the combined amperage of all the devices if the kiln must share a circuit.

GENERAL L&L KILN TROUBLESHOOTING GUIDE

Melting power cord

Look for the power cord melting if it is close to the kiln. Also look at the receptacle that it plugs into (there is often oxidation there). Look for signs of overheating; these include bulging, discolored, swollen or flattened insulation (like a slice from the side of the cord). If the cord is only slightly melted it may be OK to use if the situation that caused the melting is rectified. If the cord appears to be getting worse, replace it. If the insulation on the cord has deteriorated it is possible that the power wires could short out and cause a fire.

CONCLUSION AND REMINDERS

Remember, SAFETY FIRST. Always assume the circuit is live until you check it, the wiring is wrong until you trace it out, and that there is always more going on than what someone tells you. Slow and methodical, step-by-step with an overview of the entire situation is the best way to deal with any problem.

In most cases, your local distributor can replace parts and repair your kiln. A good electrician may also be able to diagnose and repair your kiln. L&L's technical service department can handle any type of inquiry pertaining to the kiln's theory and design, construction and use. We can also repair or retro-fit most older controls if they are sent back to the factory.

FEEDBACK

PLEASE send us your feedback and questions. We are particularly responsive to email because it allows us to research problems, questions and concerns at a less hectic pace. We will get back to you. We want to make this Troubleshooting Guide and all our documentation the very best in the industry. You can send your email to service@hotkilns.com. You can email the president of the company direct at steve@hotkilns.com. Although we like email don't hesitate to call or fax. We are here to help.

BASIC ELECTRICITY FOR TROUBLESHOOTING KILNS

BASIC ELECTRICITY

Ohms Law: Amps, Volts, Ohms, and Watts

Ohms Law governs electricity. It provides formulas that show the mathematical relationships inherent in the nature of the phenomenon we call electricity.

Electricity is analogous to water

Electricity is easiest to understand when compared to water flow and pressure. As far as your kiln is concerned, its supply of electricity is like a huge reservoir of water. Imagine that a kiln is like a bucket with small holes for the water to leak out of (which would represent the heat loss of the kiln). Imagine that the water flowing into the bucket is like electricity. To fill two different sized buckets with the same porosity (i.e. same number of small holes per square inch which would be like the standard heat loss in firebrick) you will need different flow rates of water. If you turn on the small 2.6 cubic foot model J18, electricity will flow into the kiln at one particular rate, measurable in “watts” per hour (actually Kilowatts per hour, or kWh, 1000 watts = 1 kWh). If you turn on L&L's largest kiln, the 34.5 cubic foot model T3445, electricity will flow into it at a much greater rate, still measurable in watts per hour. Likewise the larger bucket needs more gallons per hour than the smaller bucket not only to get filled at the same speed but to get filled up at all (because of the porosity). This analogy can help you to understand why it takes longer or might even be impossible for some kilns to heat up to very high temperatures. Note that the heat loss gets greater as the kiln gets hotter so it takes more and more electricity to heat a kiln the hotter it gets. It is like the porosity increasing over time as you fill up the bucket in the above analogy.

Amps (amperes) = flow

If the volume of water can be measured in gallons per second, then the volume of electricity flowing is measured in “amps”, a particular amount of electrons flowing through a wire in one second.

Volts (voltage) = pressure

Water is forced through the pipes by water pressure. A water tank at the top of a hill will provide you with more water pressure than a water tank only half-way

up the hill. Electricity is forced through the wires by electrical pressure, called volts. A 12 volt battery is like the lower water tank: there is not much voltage to push the electrons along the wire. A 120 volt house power source is like the higher water tank, pushing a much greater volume of electricity (many more amps) down the same diameter wire than the 12 volt source.

Ohms (resistance) = resistance to flow

Say your house in the valley is somehow fed by both of these two water tanks. Sink number one has water from the top-of-the-hill water tank flowing to it. Sink number two, which is right next to sink number one, has water from the half-way-up-the-hill water tank flowing to it. Sink number one will have much greater water pressure and much more water coming from it than sink number two (assuming the same size orifice in the faucet). To get them to flow at the same rate, you must use a smaller diameter pipe to connect the water to sink number one than the pipe connecting the water to sink number two. By restricting the heavier flow of water with a smaller pipe, you can make the same amount of water come out of each sink. Electricity can be restricted (or “resisted”) as well. A small diameter wire can resist electricity like the smaller pipe resisted the water. In the same way that a large pipe will let more water through than a small pipe, a thick wire will have less resistance and will allow more electricity through than a thin wire. A short wire will have less resistance and let more electricity through than a long wire. This amount of electrical resistance can be measured in terms of “ohms”. The higher the number of ohms, the higher the resistance of the circuit.

Watts (power) = work

In the same way that the combination of water pressure and the actual water itself (measured in gallons per second) comes together to perform “work”, the combination of voltage (pressure) and amps (volume) comes together to perform “work” as well. This electrical work is measured by multiplying the values of the volts and the amps together. The result is called “watts”. Watts are a measurement of the work done by electricity.

BASIC ELECTRICITY FOR TROUBLESHOOTING KILNS

Mathematical Relationships (formulas)

For use with single phase only:

The electrical industry has designated letters to stand for amps, volts, ohms, and watts.

Amps = "I" (think "intensity of amperage")

Volts = "E" (think "energy")

Ohms = "R" (think "resistance") (Ω is the symbol used to indicate ohms)

Watts = "P" (think "power")

Ohms Law in diagram form:

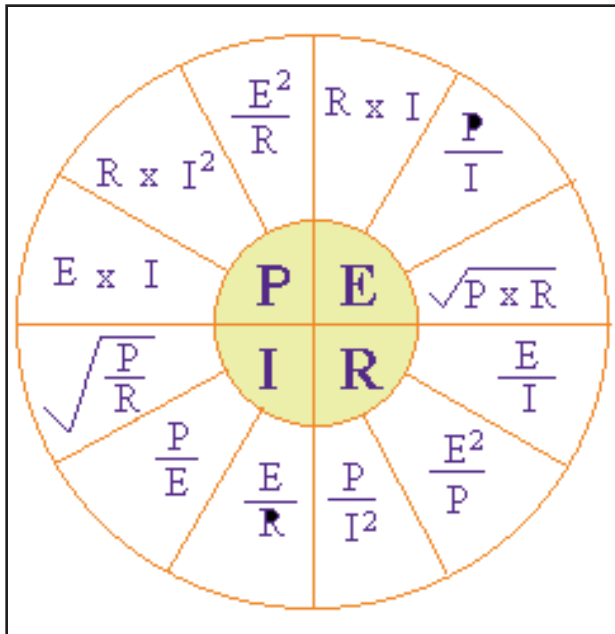

Where you can get more information about electricity

www.hotkilns.com/volts.pdf

www.elec-toolbox.com

Single Phase Power

Like voltage, the phase is specific to each location. The huge electrical lines you see across the country use three "hot" lines, what is termed "three phase", with 1000's of volts running through them. From these three "hot" lines any two can be tapped (eventually, after stepping down the voltage through transformers) to provide power for any single phase circuit. To use a small electrical appliance as an example, if you trace the two wires that make up the

cord for the appliance back through the lines you will eventually end up at two of the three wires from some main power line, and from there back to the generating plant. Often the power for a residential area is all single phase, from a junction station to a single house in the neighborhood. There may be no way for three phase power to be obtained without the equipment (mainly the extra line) in place. Industrial areas, large facilities, and schools usually have access to three phase power. Even then, sometimes the three phase ends at the main junction box in the building and the single phase power supplies branch out from there.

Three Phase Power

Three phase power uses three "hot" wires to supply electricity to the circuit. From the main power supply, the three lines remain three lines all the way through to the circuit. The same amount of electricity is simply split over three wires instead of two. The benefit of three phase is not a lower electric bill, since the kilowatts used are still the same. The benefit is in the cost of setting up the supply line itself. For example, a model T3427 208 volt in single phase draws 119.88 amps. It will need two "2/0" awg wires to supply it with power. The circuit breaker would need to be a two pole, 150 amp breaker, and any safety switches would need to be rated for at least 150 amps, if not more. That same kiln in three phase will draw 69.21 amps. It would only need three 2 awg wires to supply it with power. The circuit breaker would only need to be a three pole, 90 amp breaker, and any safety switches would only need a 90 or more amp rating. The cost of material and components for creating electrical lines are expensive. This cost increases exponentially with the size of the service. A 2/0 awg wire costs considerably more per foot than a 2 awg wire. The size of the conduit that houses the wires costs more as the diameter increases. A 150 amp circuit breaker is large and has a heavy protective housing. It has mechanical arms to provide leverage and physically move the electrical contacts together or apart. A 90 amp breaker is more familiar looking, with its plastic switching arm and the way it sits side-by-side with the other breakers in the box. The total cost (especially if power needs to be run for some distance) is much less for three phase than for single

BASIC ELECTRICITY FOR TROUBLESHOOTING KILNS

phase. The cost for another wire in the three phase is almost always offset by the potentially vast difference in total cost between installing single and three phase.

SERIES CIRCUITS

A circuit that only has one path over which current can flow is a series circuit. A break in any part of a series circuit stops current flow. All components in a series circuit see the same amount of current; therefore, each component must be capable of carrying that number of amperes.

RULES FOR SERIES CIRCUITS

- 1) The value of a current flowing in a series circuit is the same through all parts of the circuit.
- 2) The total voltage of a series circuit is equal to the sum of the voltages across each part of the circuit.
- 3) The total resistance of a series circuit is equal to the sum of the resistances across each part of the circuit.
- 4) Line voltage is divided across each component in a series circuit in proportion to the component resistance values. Referring to the schematic below, the total resistance is ($25\Omega + 30\Omega = 55\Omega$). Voltage measured between points A and B is:

$$240 \times (25\Omega/55\Omega) = 109 \text{ Volts.}$$

Voltage measured between points B and C is:

$$240 \times (33\Omega/55\Omega) = 144 \text{ Volts.}$$

Series Circuit:

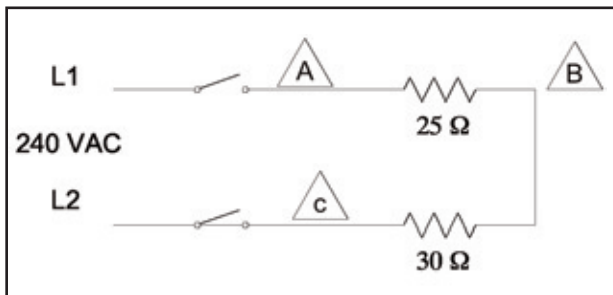

If there were (2) resistances whose values were equal, the voltage would be divided equally in half, and would measure 120 Volts.

Measuring Resistance in Series Circuits

The total resistance of the circuit is the sum of all individual resistances.

PARALLEL CIRCUITS

A circuit that has two or more current paths is a parallel circuit. Each component is connected to line voltage, and current still flows through part of the circuit if one component fails. Each component must be capable of withstanding line voltage. The number of amperes varies according to the resistance of the component.

The more circuit paths, the less opposition to the flow of electrons. Total circuit resistance decreases when more paths are added.

RULES FOR PARALLEL CIRCUITS

- 1) The total current supplied to a parallel circuit is equal to the sum of the currents through the branches.
- 2) The voltage across any branch of a parallel circuit is equal to the supply voltage.
- 3) The total resistance of a parallel circuit is always less than the resistance of any of the branches.
- 4) The following parallel circuit is typical of the DaVinci, Doll and J2900 kiln rings; there are (3) elements per ring, connected in parallel.

In this example, each element has a resistance of 49.8Ω . At 240 VAC, each element develops

$$(240 \text{ VAC}/49.8\Omega) = 4.82 \text{ Amperes}$$

The total circuit amperes, then, is

$$4.82 + 4.82 + 4.82 = 14.46 \text{ Amperes.}$$

Parallel Circuit:

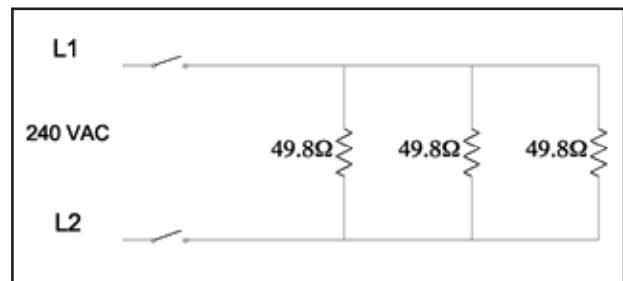

BASIC ELECTRICITY FOR TROUBLESHOOTING KILNS

Measuring Resistance in Parallel Circuits

The total resistance is always less than the lowest reading of a single element. Often this is difficult to measure if all the elements in the circuit are connected to two points with no way to isolate them. If they are known to all have the same resistance then you can multiply the number of elements by the resistance value of the entire circuit to get one element's approximate resistance. If the elements in the circuit have different resistances, like in B model kilns, there is no easy way to determine the individual resistances of the elements. The best way to solve an element problem with these kilns is to replace all the elements in the troublesome circuit

SERIES/PARALLEL or COMBINATION CIRCUITS

Certain circumstances require the use of Series/Parallel, or Combination, circuits, in which series and parallel circuits are combined. In some front-loading industrial furnaces these circuits are used to combine, for instance, sidewall heating elements and backwall heating elements (often shorter than sidewall) in a branch circuit that is controlled by a power relay.

Series/Parallel Circuit:

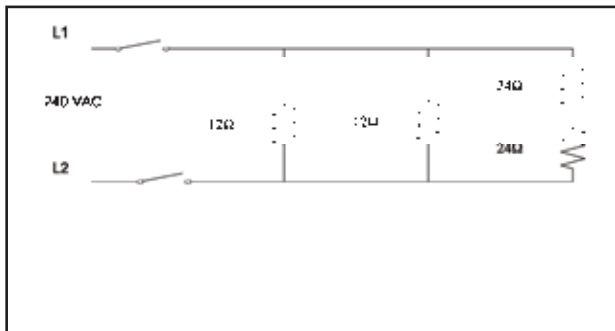

In the above example, the total resistance can be found by first dealing with each branch circuit individually. Starting from the right, this circuit is a series circuit; add the ($24\Omega + 24\Omega = 48\Omega$). The other two circuits are parallel and are equal in value (12Ω each); therefore, the resistance value of these two circuits is equal to ($12\Omega/2 = 6\Omega$). Drawing an equivalent circuit with (2) parallel circuits, one of 6Ω and one of 48Ω , looks like the following:

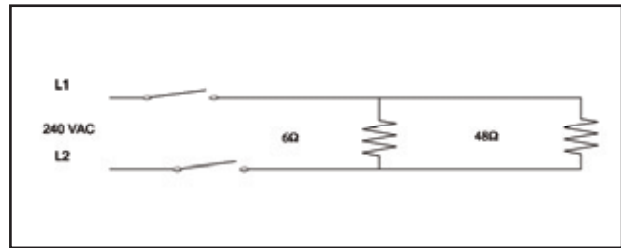

Solving for this circuit:

$$R = (6\Omega \times 48\Omega) / (6\Omega + 48\Omega) = 5.33\Omega.$$

The total resistance is lower than that for any of the branch circuits.

ELEMENT TROUBLESHOOTING & INSTALLATION INSTRUCTIONS

TABLE OF CONTENTS

ELEMENT TROUBLESHOOTING	1
Why does an older kiln slow down?	1
Elements expand and grow with age	1
What if I see charred and blacked corners?	2
Factors shortening element life	2
Element Terminal Burn-out	3
CHECKING ELEMENTS	3
Elements	3
Element Connections	4
HOW ELEMENTS ARE WIRED	4
Why is this important?	4
Series Circuits	5
Parallel Circuits	5
Series-Parallel	5
Specific to non-sectional kilns:	6
POWERED BOTTOMS	6
OTHER TYPES OF ELEMENTS	6
Heavy-Duty elements	6
APM Elements	6
Increasing Power in Your Kilns	6
REMOVING OLD ELEMENTS	7
CHECKING ELEMENTS	8
STRETCHING ELEMENTS	9
JUPITER ELEMENT STRETCH LENGTHS	9
IF ELEMENTS NEED TO BE STRETCHED	9
INSTALLING NEW ELEMENTS	9
FIRST FIRING WITH NEW ELEMENTS	10
REPLACING ELEMENT HOLDERS	10
Method #1	10
Method #2	11

ELEMENT TROUBLESHOOTING

Why does an older kiln slow down?

Old elements generally increase in their resistance. Mathematically this increase in resistance will decrease the amount of amperage and, ultimately, the amount of heat given off by the elements. This is why older kilns sometimes go so slowly and may not reach their maximum temperature. Periodic element resistance readings using the multimeter will allow you to check the “health” of your elements. Of course, a slow firing kiln is the first indication that you have an element problem.

Elements expand and grow with age

If you fire low-fire clay and glazes and never get above cone 4 or so, your elements will last a long time, especially if you are only bisque firing. This is good, to a point. If you only low-fire, the problem you are most likely to encounter over time is that the elements expand as they age. The length and the coil diameter increase. Meanwhile the atmosphere in the kiln slowly eats away at the metal of the element. Although the total resistance usually increases as the elements age, sometimes it decreases, or reverses itself. This usually only happens when the elements are very old but have not yet failed completely. As the element expands, it binds up in the corners. This can make the individual coils push together and touch each other in the corners, making a short cut for the electricity, reducing the amount of element material the electricity must pass through, and therefore reducing the resistance in the whole element. This may make it hotter in the kiln, but if there is a lot of element material jammed in the corners there will not be enough material left in the coiled form to radiate the heat generated by the increased amperage and decreased resistance. Only the parts of the wire not touching the coils on either side of them will emit heat. More amperage through the electrical components in the control could cause damage if the situation continues or the resistance drops far enough.

In addition, the expanding diameter of an element can make it difficult to get it out of the holder. Usually this will not happen to those firing to higher temperatures because the maximum temperature of the kiln is quickly compromised by increases in the resistance,

ELEMENT TROUBLESHOOTING & INSTALLATION INSTRUCTIONS

requiring the elements to be changed long before they can jam up in the corners. Also, high temperatures and glaze firings are more prone to eating through the element, causing it to fail, before the element can expand enough to cause the problems mentioned above. Use the multi-meter. Visually inspect your elements.

What if I see charred and blacked corners?

The coils that sometimes get squashed together in the corners do not always touch each other, but they may be close enough to allow the electricity to ‘arc’ across the gap. An electrical arc can generate extreme temperatures for the millisecond it arcs. Charred and blackened corners of the kiln are warning signs for this problem.

Do not confuse this with what can be observed even with new elements; which is randomly sized sections of the coils glowing more quickly than other sections of the same coil. The annealing process of the wire causes this, and does not adversely affect the elements’ operation in the kiln.

Factors shortening element life

1) Contamination (such as glaze or kiln wash). Silica, a main ingredient of both of these, attacks the element wire.

2) Tightly wound areas on element coils resulting from improper stretch. Have the elements been stretched evenly? This is important. If the element coils are bunched up along the length of the element the element will overheat where the coils are too close. Some replacement elements are shipped unstretched. Even prestretched elements may need some stretching. See section below on stretching elements.

3) Glaze accidentally rubbing off into holder and on element in loading kiln. If this occurs immediately vacuum the kiln and element holders thoroughly.

Glaze will cause very rapid element failure.

4) Blow ups or explosion of bisque ware cause small pieces of clay to be blown into holder and element. If not immediately removed clay may melt, contaminating the element and element holder. Keep in mind that temperatures are considerably higher right next to the element so that you may very well exceed the clay

melting temperature next to the element even if the kiln temperature is correct for the clay body.

To avoid explosions make certain clay is very dry before firing and, in the case of heavy handmade pieces, fire on low for a long period until you are sure ware is dried out thoroughly. If you hear a “pop” when firing such pieces, stop firing, cool the kiln. If blow-up has occurred, vacuum all element grooves very thoroughly. If you have the DynaTrol use the PreHeat feature for this final forced drying.

5) Firing pieces too close to elements. We recommend at least 1-1/2” from piece to element. Further if large flat surfaces are parallel to kiln wall.

6) Reducing atmospheres will destroy elements. Do not use wood chips, oils and other materials to generate a reducing atmosphere. A very rapid element failure may result. NOTE: Reducing atmospheres are the opposite of oxidizing atmospheres (plain air is an oxidizing atmosphere). The word reducing comes from the ability of a reducing atmosphere to “reduce” oxides.

7) Are any waxes, oils, carbon, fluorine, fumes present? Are you using any lead glazes? Iron-Chrome-Aluminum elements require an oxidizing atmosphere to give dependable service. The aluminum in the element forms a protective aluminum oxide. Oil from tools or carbon from wax burnout will attack the element coating. Halogens such as chlorine or fluorine will attack the elements. Molten metals, for instance, zinc, aluminum and copper, react with iron-chrome-aluminum elements. Moreover, these metals oxidize easily and their oxides have an unfavorable effect on iron-chrome-aluminum. The salts of the alkali metals, halogen salts, nitrates, silicates, and compounds of borax, disturb the formation of oxide and are, therefore, harmful to these elements. This is also true of the oxides of such metals as copper, lead and iron. Do not use with free carbon. Lead oxide attacks the protective alumina oxide coating on the element. If you are using lead glaze (or are creating any of these other problems) be sure to use a kiln vent. **Also try firing every other load or as often as you can with a non corrosive load (such as a bisque firing).** This will help the element restore its protective alumina oxide coating. Note that clay almost always has organics (which will create a

ELEMENT TROUBLESHOOTING & INSTALLATION INSTRUCTIONS

slightly reducing atmosphere, sulfur (which will also attack elements) and fluorine which is also corrosive. **This is one reason why proper venting is critical for long trouble-free operation of your kiln.**

8) Excessive soaking time will accelerate increase in element resistance. The higher the temperature, the longer the soak, the sooner the element will decrease in life. Usually short soaks work fine.

9) Are they genuine L&L elements? There are a number of people selling “replacement elements” for kilns. These people do not have access to the proper design information for L&L elements. Designing an element is a complicated process which balances such things as voltage, wire diameter, watt density, stretch ratio, etc. It is very easy to make an element that has the same watts as an L&L element and have nowhere near the other design qualities that result in long element life.

10) If the failure is taking place at the element end it may be twisted too tightly, causing stress at terminal through holes. This causes local overheating at the “through hole”, and element failure. (Contact factory).

11) Make sure all elements are heating. If all elements are not doing their share of the work then the other elements will not last as long.

Element Terminal Burn-out

Sometimes the ends of the elements can burn out at the element terminals (connections). This can be due to any or all of the following causes:

1) The element ends are not twisted properly. If the twist is too loose this could generate extra heat at the element ends.

2) The holes where the elements go through the firebrick walls are too large. This could cause too much heat to escape from the kiln thereby overheating the element terminals. This can be remedied by lightly stuffing ceramic fiber (we have non-RCF ceramic fiber available in our parts list) in the element holes.

3) The element connection hardware may not be tight enough. A loose connection can generate heat and cause oxidation of the hardware which in turn will cause a worse electrical connection (because of re-

sistance) and more heat. Replace with new hardware. There should be a lock washer (so the screw terminal does not turn), and a washer on either side of the element as it is turned around the screw.

4) The hardware should be stainless steel or at least nickel plated. Check to see if the hardware is in good shape. If not replace at least the hardware with stainless steel hardware or better yet replace the whole terminal board assembly with one of our new ones.

CHECKING ELEMENTS

Elements

The elements are the least stable variable in a kiln and should be examined before anything else. Use the multimeter to test the elements’ resistance (ohms). Note that element resistance changes over time, the hotter and more often you fire the quicker they change. As the resistance goes up the kiln will slow down because it is getting less power.

You may not need to replace any elements, but you must at least eliminate them as a potential source of the problem. There are a couple different tests you can perform on the elements while they are still in the kiln. But keep some important points in mind. Each element only goes around the kiln once in its ceramic holder. It is important to know the factory resistance value of one element for the kiln you are testing if the elements are all the same. B models and older G models (not the GS1714) use different elements within the same kiln. Likewise, the 6 ½” high JR18 and KR18 sections use different elements than the 9” high sections in the same J and K model kilns. (This is NOT true for the 6-1/2” high J14R and K14R sections). In these cases the factory resistance values for all the elements involved is needed. This information is located in the appropriate instruction manual (all can be downloaded from hotkilns.com/pdf.htm (our PDF library).

With these values in mind, **and all power OFF**, place the test leads of the multimeter on the two flat prongs of each section’s jumper cord, one on each prong, OR on both connecting wires, at the connection points with the elements. Compare the reading you get to the readings you get from the other jumper cords or

ELEMENT TROUBLESHOOTING & INSTALLATION INSTRUCTIONS

connecting wires.

If all the readings are the same, compare the readings to the factory resistance value of one element. If the kiln section has two or three elements in it you can divide or multiply the factory resistance value of the one element by the number of elements in the section and match this to what readings you have taken from the jumper cords. The total resistance of each kiln section - as wired- is provided in our instruction manuals so you do not need to do the math. If the readings on your elements are more than 10% over the factory resistance values the kiln will climb in temperature very slowly and may not reach maximum temperature.

How to check ohms of an entire L&L kiln section. Put the test leads of the multi-meter on the two "hot" plug terminals:



Element Connections

When running these tests, keep in mind that power to the elements is transmitted from your house, through the control panel and into the jumper cords or connecting wires. Then, either inside the element boxes (J, JD, automatic D, and DaVinci models), or behind the baffle in the control (Easy-Fire, SQ, B, K, H, G, and manual D models) these cords or wires end at the element connections. In general we have used element connections with screw terminals as shown below. The element's tail is wrapped around an element connection bolt. Then one wire of the connecting wires or jumper cord is attached to that same bolt. The other wire (not the ground wire if you have a jumper cord) goes to another bolt in the same circuit where another element tail is wrapped. In some kilns these elements are wired in series and in some kilns the elements are

wired in parallel.

HOW ELEMENTS ARE WIRED

Why is this important?

The way the elements in a particular kiln are wired is important. Different wiring schemes with the same resistance elements will yield drastically different results. For example, if a kiln section or group of elements is out, and the kiln is made up of series circuits, you would first look at the elements because even one element out in a series circuit can make all the elements in that circuit appear to be burned out. If this same kiln had parallel circuits you would first look at the switch or relay. This is because in a parallel circuit, if one element is out the others will still light, so for all the elements in the parallel circuit to be out would mean that whatever controls the circuit (i.e. the switch or the switch by way of a relay) or the wires in-between would be suspect. CAUTION: Accidentally wiring a kiln with parallel element circuits will make it heat up incredibly fast, until the breaker trips. For instance, A J18 kiln wired properly, in series, draws 23 amps at 240 volts. Wired in parallel it would draw around 90 amps at 240 volts, which would be disastrous.

Series Circuits

A typical element terminal board on an older J kiln. The grounding jumper wire that goes from one of the mounting screws to a stud on the element cover box **MUST BE ATTACHED FOR SAFETY!** This shows elements wired in a series circuit (you can tell because two elements are tied together on one of the terminals and no power wires go to that terminal). You can see that the two elements are connected in series.

ELEMENT TROUBLESHOOTING & INSTALLATION INSTRUCTIONS

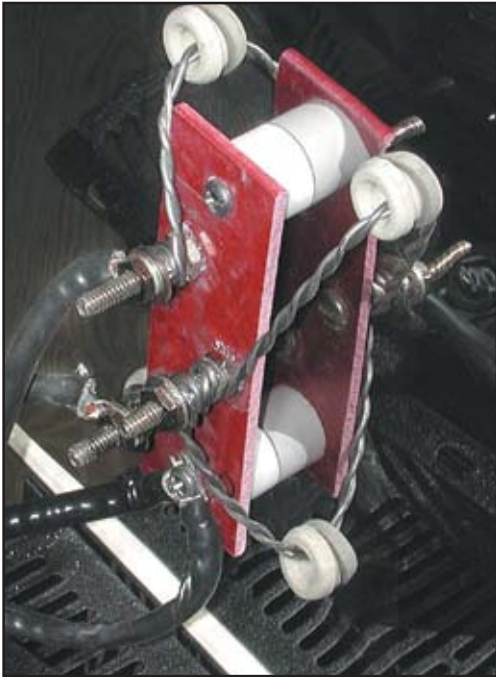

From the above photograph of a series circuit (typical on our smaller kilns with only two elements per section) you can see that the two elements are connected at one of the bolts. This means that power flows in series from one element to the next as if it were one long element. The bolts with only the element tails wrapped around them are simply connecting points within the series circuit. Rather than actually stretching the same element twice or three times around the kiln, L&L connects a series of elements together -- usually just two per series -- on the element connection board. Power is applied to the beginning of the first element and to the end of the last element. The electricity must travel through one element to get to the next one. The resistance of the entire circuit would be the number of elements in the circuit multiplied by the factory resistance value of one element.

Parallel Circuits

This is the new all-ceramic terminal board we are using on the Doll, DaVinci and J2900 Series kilns. It shows a parallel circuit. You can also see the sheathing over the wires from the jumper cord as well as the ground wire.



Parallel circuits are another way of wiring elements in the kiln. The element connection bolts in these circuits have two or more element tails wrapped around them; all the bolts have power wires attached to them. Parallel circuits use only two element connection bolts per circuit. The power is applied to the beginning and end of ALL the elements at once. Thus the resistance of the entire circuit is the number of elements in the circuit divided into the factory resistance value for one element.

Series-Parallel

Sometimes element wiring can be termed series-parallel. L&L's model J14 is a good example of this. It has two series circuits, wired in parallel. The model J230 is wired the same way, but its two series circuits are not as easy to recognize because each series circuit has only one element in it.

The J14, however, has series circuits with two elements in each one. Power still comes through the two wires inside the jumper cord, and goes to both ends of each circuit. At one of these ends, another wire, a 'jumper', conducts the electricity to the end

ELEMENT TROUBLESHOOTING & INSTALLATION INSTRUCTIONS

of the other series circuit, which begins at the end of the first circuit so they can share one power wire. Thus, both series circuits get power at the same time, making them series-parallel circuits. What this does to the total resistance of the J14's element circuit is intriguing. If each element has 10 ohms, each series circuit has 20 ohms (2 elements multiplied by 10 ohms each). Two 20-ohm circuits wired in parallel equals 10 ohms total resistance, just like with one element, except now there are four.

Specific to non-sectional kilns:

In non-sectional kilns it can be difficult to tell the element circuits apart since the element connection board runs the entire length of the kiln and covers all the circuits. Trace the connecting wires to discover the beginning and end of each element circuit on the element connection board. Ideally, you would draw a picture of each element circuit before dismantling it. If you are just replacing the elements it is not necessary to know if they are wired series or parallel; it is imperative, though, that they go back together exactly how they came apart.

For a more in-depth description of Series, Parallel and Series-Parallel circuits, along with descriptive diagrams see *troubleshoot-electricity.pdf* in the TROUBLESHOOTING Section for more information on circuit wiring. If you want even more information about electricity for kilns see *hotkilns.com/volts.pdf*.

POWERED BOTTOMS

The elements on the powered bottoms are exactly the same as used in the kiln sections. One is used on the JB2300 and two are used in the JB2900 and in all the powered bottoms in the DaVinci series.

OTHER TYPES OF ELEMENTS

Heavy-Duty elements

If your kiln was made after January of 1996 (the year and month are coded into the serial number) it has larger cross-section element holders. These new holders are capable of holding a larger diameter, heavy gauge element. These high grade heavy duty elements feature lower watt density than the standard elements

and that, coupled with the heavier gauge wire, results in longer element life. If you are experiencing short element life because of your duty cycle (frequent firing, high temperature firing, long soak times) you should try these heavy duty elements. They have the same ohm rating (resistance) as the standard elements. This means that the power rating of the kiln does not change. It also means that you can use them with the standard elements. One consideration with mixing the standard and heavy duty elements is that the heavy duty elements will age more slowly than the standard elements and may have an effect on uniformity in the kiln. This is really no different than what you would experience when you change just one element and so have a new element (unaged) with older elements. Dynamic Zone Control will automatically balance your system and compensate for this problem. We do suggest, however, that you put any newer elements in the bottom ring where temperatures tend to be cooler and hence need as much power as they can get. Keep in mind that L&L can not keep track of which elements you have and that you must specify heavy duty elements when ordering. If you don't specify heavy duty elements you will get standard elements.

APM Elements

APM is a special version of the Kanthal A-1 alloy used on kilns. It is sintered and resists the crystallization that normal Kanthal type alloy experiences. As a result it makes sense to use this when you are doing processes that require long holds at high temperatures (like crystalline glaze for instance). On the other hand these elements are very expensive and a subject to the same problems like glaze contamination that any elements can experience. See *apm.pdf* in our web PDF library for more information.

Increasing Power in Your Kilns

If you have a JD230 you can retrofit the new Easy-Fire e23T elements in that specific model and increase the power rating of the kiln. That will give you about 10% more power to start with and therefore, as elements age, the lowering power will have less impact on your firings. See *e-jd-element.pdf* in our web PDF library for more information.

ELEMENT TROUBLESHOOTING & INSTALLATION INSTRUCTIONS

REMOVING OLD ELEMENTS

1) Unplug kiln or turn off the kiln at the fused disconnect switch.

2. First remove the control box or element boxes and their wire connections from the kiln. Before undoing any wires, however, label how the wires and the elements are configured inside the element boxes or behind the control panel. (You could also draw a picture or take digital pictures). To do this, remove the control or element boxes but do not take off the wires. Draw a picture of or photograph the inside of the box and/or label which wires go where. After you are certain you have documented the wiring then you can carefully remove the wires.

3) Using a 3/8" nut driver remove the nuts that hold the element end onto the Element Terminal Bolt. If you don't have this tool you can use an adjustable wrench - it will just take longer.

A 3/8" nut driver:



4) Untwist the element end from around the Element Terminal Bolt. Straighten it out as much as possible.

Untightening the element terminal:



5) Cut the old elements off as close to the "through hole" on the outside of the kiln as possible. You want a straight element tail to pull through the through hole, not a crooked one.

FOR OLDER NON-CERAMIC TERMINAL BOARDS: Remove all the old tails from the element

connection bolts and re-tighten these bolts to the element connection board. You may have to remove the element connection board from the kiln to do this. If the bolts are corroded, replace with new stainless steel terminal bolts, nuts, and washers. If the terminal board itself is burnt or broken replace that as a complete unit with new hardware.

6) In most cases you can just lift the element out of the holder at this point. Sometimes, if the element has really disintegrated, you need to remove it in pieces with needle nose pliers.

Using a sharp tool like a screw driver lift the elements out of the ceramic grooves at the corners. You can slide the holder over to make enough of a gap to get the tool under the element:

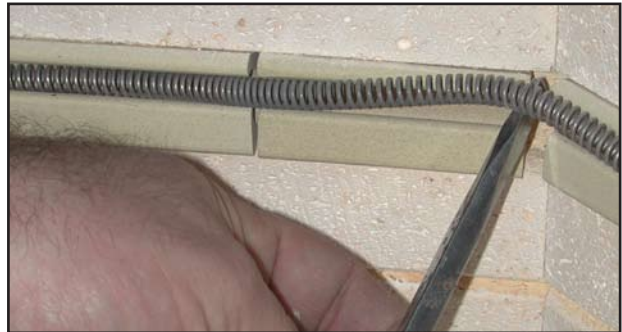

Lift Elements out of the groove of the ceramic holders:



Sometimes very old elements can become wedged in the element holders, making it necessary to carefully pry/twist/ break them out. A propane torch or just turning the kiln on for a few minutes (if it will come on) will soften the wire of the elements and make them easier to get out. Use heat protecting gloves such as welding gloves or heat treating gloves (you can buy these from L&L) and a pair of needle nose

ELEMENT TROUBLESHOOTING & INSTALLATION INSTRUCTIONS

pliers to pull out the softened element. **DANGER:** You could burn or electrocute yourself if you get the elements too hot or forget to unplug the kiln after warming them up. **IF YOU DECIDE TO USE THIS METHOD BE VERY CAREFUL OF THE POTENTIAL FOR BURNING YOURSELF.**

7) Be sure to check for failure points for evidence of contamination on the element and the element holder. If the element holder is contaminated it will cause rapid failure of the new element. Replace contaminated holders with new ones (See later in this sheet how to do this).

8) From the inside of the kiln, using needle nose pliers, grab the element as close to where it goes through the brick wall to the Terminal Block. Pull the element end through the hole. Be careful not to enlarge the hole in the firebrick. The brick is quite soft and will not take much abrasion.

Removing element from inside the kiln:



9) **FOR OLDER MODELS WITHOUT CERAMIC TERMINAL BOARDS:** There are normally ceramic insulator bushings on the outsides of the through holes that the elements pass through. On some models (particularly older J2900 kilns and DaVinci kilns) there are spacers to keep these insulators in place. These may fall out (and chip or break) if you are not careful. Be sure not to lose these spacers when replacing elements. Note carefully how they are positioned so you can replace in the same way. Note that on the new all ceramic terminal boards used on the J2900 and DaVinci kilns there are no bushings or spacers - it is all one integrated piece.

10) Once the old elements are out, carefully vacuum all the element holders. Watch for any glaze or material contamination. Anything that will melt (i.e. glaze, slip, porcelain, etc).will cause rapid failure of

the new element. Chip or scrape carefully to remove the contaminant, or replace the affected element holders. **DO NOT** replace the element if there is foreign material stuck in the element holders. You must fix that problem first by either cleaning or replacing the contaminated element holder.

CHECKING ELEMENTS

Examine your new elements. Look to see the wire thickness is similar to that of the old ones. Look to see that the coils per inch and the diameter of the coils are also similar. Using your multimeter check the resistance of your new element. Compare to the factory resistance value(s) for your kiln's elements. Your reading should be no more than one ohm off (less for elements with ohm readings of less than 10 ohms). If you have received the wrong element in error call the factory to get it exchanged. This is the time to deal with the problem. **DO NOT WAIT UNTIL YOU HAVE STARTED THE JOB, STRETCHED THE ELEMENT OR EVEN INSTALLED IT BECAUSE AT THAT POINT YOU WOULD NOT BE ABLE TO RETURN IT.**

Checking resistance of the elements before you put them in. This is a good double-check and can save you a lot of trouble if there is a mistake. Put the probes on the twisted element ends about 3" from the beginning of the coil:



ELEMENT TROUBLESHOOTING & INSTALLATION INSTRUCTIONS

STRETCHING ELEMENTS

NOTE: Most replacement elements come prestretched. All elements are slightly understretched and will have to be adjusted for final fit. The following are instructions for how to stretch unstretched elements:

To determine total length to stretch an element measure total length of element grooves. The following are the dimensions for elements that go in the ring sections. The dimensions given are only the coiled part of the element and does not include the twisted pair ends.

JUPITER ELEMENT STRETCH LENGTHS

J1800	55-1/2"
J2300 (Side Rings)	72-1/2"
J2900 (Side Rings)	92"
J2300 (Bottom)	158"
J2900 (Bottom)	87"

IF ELEMENTS NEED TO BE STRETCHED

1) Mark floor with two marks for stretched length. Have a helper stand on the tail of one element, and pull the other tail until the element is the proper length. The assistant must stand very firmly because a flying element could cause severe injuries. **WEAR SAFETY GLASSES WHEN YOU DO THIS.** Alternately clamp the end to something with vice-grips.

2) Initially stretch element about 50% of length of its final fully stretched length. Examine for evenness of stretch. Selectively stretch close wound sections to provide uniformity of stretch.

3) Repeat this procedure several times.

4) You will have to pull element beyond last mark in order to obtain full stretch.

5) If overstretch occurs insert a metal rod or small diameter dowel into the element coil and compress with needlenose pliers.

6) Stretch uniformity is necessary for satisfactory element life.

INSTALLING NEW ELEMENTS

1) Replace one element at a time so that you do not make a mistake with the wiring.

2) Clip any loops off the end of the tails and insert them through the through holes from the inside out. Element ends should be straight at this point.

Cut off the loop at the end of the element:



2) Pull them up tight up to the wall of the kiln by pulling from outside the kiln.

3) Lay the element into the groove. Note that the unfired element is going to have some springiness to it before it is fired for the first time. You may need to use a screw driver to press the element into the holder. **YOU DO NOT NEED PINS.**

4) FOR KILNS WITH NON-CERAMIC TERMINAL BLOCK OR ON RETROFITTED KILNS WHERE YOU HAVE ADDED A CERAMIC TERMINAL BLOCK BUT STILL NEED BUSHINGS: Be sure to replace the insulators and spacers over the element tails.

5) Consulting your picture or labeling, wrap the appropriate element tails around the appropriate element connection bolt, clockwise, once around, and cut off the excess tail.

6) Install the elements and hardware:

a) A washer goes under the first element

b) Twist the first element end **CLOCKWISE** around the Terminal Bolt.

c) The next element gets twisted around the Terminal Bolt on top of the first element.

d) Then another washer goes over the Terminal Bolt.

ELEMENT TROUBLESHOOTING & INSTALLATION INSTRUCTIONS

- e) Then the nut goes over it and get tightened.
- f) Then a washer goes on.
- g) Then the Ring Terminal of the Power Lead Wire goes on.
- h) Then a washer goes on.
- i) Then another nut goes on and gets tightened. How tight you can make this is dependent on how tight you got the element connection bolt onto the element connection board. A tight connection is very important, but if you tighten too much and twist the element on the bolt too far you could break the element, the bolt, or the insulator.

Detail showing how all the hardware gets assembled on the Terminal Bolt:



- 7) Place the wires from the jumper cord or connecting wires onto the appropriate bolts and tighten with stainless steel nuts.
- 8). Reattach the ground wires and the element box if the kiln has them. **DO NOT FORGET TO ATTACH GROUND WIRES. IF EACH KILN SECTION IS NOT GROUNDED THIS CAN BE VERY DANGEROUS.**
- 9) Test the ohms at the jumper cord's plug head or at the other end of the connecting wires.
- 10) Reattach the control box, turn the kiln on and make sure all the elements come on.

FIRST FIRING WITH NEW ELEMENTS

NOTE: You may experience some smoking from the kiln on its first firing with new elements. This, if it occurs, is due to residual oil left on the element wire when the wire was made. We recommend firing the kiln empty to cone 5 once to oxidize the new elements

(no particular speed is necessary).

REPLACING ELEMENT HOLDERS

1) When ordering a new holder provide model number of kiln and length of the element holder. See the Parts List for this information.

2) Note that if the holder has melted badly you may need to either replace the brick that holds it or at least patch the brick with our Brick Repair Kit.

Method #1

1) This method leaves the kiln in tact. You break up the holder and remove it in pieces and then modify the new holder to snap into the groove.

2) Using a chisel or large screw driver and a hammer carefully crack the holder that needs to be removed.

Just take your time with this. You can break the holder into little pieces so that it comes out:



The holder shown with about half the job done:



The groove is shown with the holder removed:

ELEMENT TROUBLESHOOTING & INSTALLATION INSTRUCTIONS



Using Linemen's Pliers snap off the **BOTTOM** edge of the holder (note carefully the fact that the **BOTTOM** of the groove is closest to the edge that you are breaking off.):



A normal holder compared to one with edge removed:



You can now just snap the new holder into the slot in the firebrick. It will hold in place with no cement:



Method #2

This method requires you to take the kiln sections apart.

- 1) Take the section with the bad holder off the kiln and put it on a flat surface like a flat floor or table.
- 2) Carefully pull the elements out of the element holders of the brick section involved and allow them to hang loose. Take great care not to "break" the element as they are very brittle after firing.
- 4) Loosen up the adjustable clamps that hold the stainless steel wrapping. Loosen them just enough to allow the brick to slide out with slight hand pressure (so that the other bricks stay in place). NOTE: If you don't have the section on a flat surface then the bricks will all come out of proper alignment at this point.
- 5) Pull up the brick with the bad element holder just enough to allow removal of the defective element holder and replace with new one. Slide the bad brick(s) out and put in new brick(s). Be sure the element holders line up with the other holders on either side. Note there is a top and a bottom in the element holder so be sure to get the orientation correct.
- 6) Retighten the clamps on the wrap. Alternately tighten the bottom and top clamp so that you don't cock the stainless casing.

TROUBLESHOOTING AND FIXING BRICK PROBLEMS

INSTRUCTIONS FOR USING BRICK REPAIR KIT

GENERAL NOTE: Firebrick is a very fragile material and subject to breakage, spalling and heat shock. The good news is that it is very easy to repair and maintain with the proper materials and techniques. Our Brick Repair Kit has all the materials you will need to do a first class job.



LIST OF BRICK REPAIR KIT MATERIALS

- (1) Firebrick piece
- (1) 1/8 pint of Phosphate Cement (in a 1/2 pint container)
- (1) Quart container of Brick Dust
- (1) 1/2 pint Brick Facing

MIXING A BATCH OF GROUT

The grout should be mixed up JUST prior to use. (Otherwise it will dry out). Mix the ingredients with a small spatula in a container (like a glass jar or plastic cup). Mix in the following:

- 1/2 cup firebrick dust
- 1/4 cup water
- 1 tablespoon Phosphate Cement

NOTE ABOUT GROUT

The special grout material is firebrick dust mixed with water and a small amount of cement. The cement makes a matrix of the firebrick dust. This compound dries into a material almost exactly like the original firebrick with the same color, consistency, texture and insulating properties.

CAUTION:PHOSPHATE CEMENT

The special cement that is used by itself and with the grout is a phosphorous based cement. It has unusually strong adhesive properties which makes it ideal for repair work. It is different from the cement we normally use for cementing our firebrick. The phosphorus makes phosphoric acid. It is best to use rubber gloves. Be sure to wash your hands with soap and water immediately following your use. **Phosphoric acid is very hazardous to your eyes. Protect your eyes with glasses.**

BRICK PROBLEMS

EXCESSIVE BRICK WEAR

- 1) Excessive brick wear can be the result of various conditions. Most common is improper curing of the brick when first fired. FOLLOW THE INSTRUCTIONS FOR THE FIRST FIRING AND CURING CYCLE. (See *first-firing.pdf* in the Operation Section).
- 2) All insulating firebrick expands and contracts when heated and cooled. Over time this will lead to cracking and spalling. Spalling is the continued cracking of the brick which eventually results in large pieces of the brick falling out from the brick section. This is a normal condition as long as the emphasis is on eventually. Factors such as how close the kiln is operated at or near maximum temperature, how often and how fast the kiln is cycled up to heat and then cooled, how heavy the loads are, all figure into the brick wear equation. There is no set rule as to how long a brick lining will last. There are some L&L kilns which are 25 to 40 years old with the original lining still in usable shape.
- 3) Frequent door openings when the kiln is at high temperatures can cause thermal shock, leading to excessive cracking and spalling.
- 4) For light to moderate spalling, re-coat the brick with the Brick Facing available in the Brick Repair Kit or separately in the Parts List. This procedure can allow the brick to remain operational.

TROUBLESHOOTING AND FIXING BRICK PROBLEMS

BRICK REPAIRS

APPLICATION OF BRICK HARDENER

- 1) First brush and vacuum the surface of the brick clean to remove any loose material or crumbling firebrick.
- 2) Next wet the brick surface lightly. Use a paint brush or spray bottle (make sure there is no soap residue in the bottle).
- 3) Then apply a thin coat of the brick hardener with a soft brush over the surface of the firebrick. Do not make too thick a coat of the hardener or it will spill off.
- 4) Let the hardener dry for 24 hours.
- 5) Run the First Firing Cycle (See *first-firing.pdf* in the Operation Section).

REPAIRING SMALL HOLES & CHIPS IN BRICK

- 1) Dig out any loose particles with a small knife.
- 2) Brush and vacuum the surface of the brick clean to remove any loose material or crumbling firebrick.
- 3) Next wet the brick surface lightly. Use a paint brush or spray bottle (make sure there is no soap residue in the bottle).
- 4) Apply a thin coat of brick cement all over the hole. This is defined as about 1/32" to 1/16" thick. Do this with your finger or a small brush.
- 5) Fill hole with the special grout material. Apply grout with a spatula (like plaster.) You can also use your finger. Push it into the hole. It is OK to let it be a rough surface or slightly larger than the hole it is filling.
- 6) Let dry for 24 hours.
- 7) Take some rough sandpaper and sand surface to even it out with the rest of the firebrick.
- 8) Run the First Firing Cycle (See *first-firing.pdf* in the Operation Section).
- 9) You can brush on hardener or facing afterward if you desire.

REPAIRING VERY LARGE HOLES IN BRICK

- 1) Cut out an area around the brick chip with a small knife, saw or router. The hole that you make should have 90° angles so that a square or rectangular block will fit in the hole.
- 2) Cut a piece of firebrick to fit into this cut out hole. The piece should be slightly smaller than the hole (by about 1/16" to 1/8").
- 3) Both the hole and the brick piece should be brushed and vacuumed clean.
- 4) Wet the brick surface lightly. (Both the hole and the surface of the block that you are going to insert in the hole). Use a paint brush or spray bottle (make sure there is no soap residue in the bottle).
- 5) Apply the Kiln Cement to the surface of the the piece that you are going to put in the hole. Use only about 1/32" to 1/16" of an inch of cement.
- 6) Let dry for 24 hours at a minimum.
- 7) Cut off and/or sand off excess brick and cement.
- 8) Cover with Brick Facing and allow to dry for another 24 hours.
- 9) Turn kiln onto low for 3 hours to dry totally.
- 10) Run the First Firing Cycle (See *first-firing.pdf* in the Operation Section).

FIRST FIRING AFTER REPAIR

(See *first-firing.pdf* in the Operation Section). The only modification is that you can fire to a lower temperature because you do not need to reseal the elements. However, firing to cone 5 instead of 05 is OK.

On the first firing of the kiln fire it empty.

For kilns with the manual control fire the kiln on low (setting #2) for two hours to bake out any moisture. Then set to medium (setting #5) for two hours and then increase enough to reach final temperature. Fire it to cone 05 (1888°F).

If you have the DYNA-TROL program control fire the following program: Using the "Easy-Fire" mode fire on Slow Bisque to Cone 05 with a PreHeat setting of 3 hours and a hold of 1 hour.

TROUBLESHOOTING AND FIXING BRICK PROBLEMS

CRACKS IN THE LID & BOTTOM

- 1) It is quite normal to get hairline cracks in both the lid and the bottom firebricks.
- 2) They are caused by the expansion and contraction of the firebrick as it heats and cools.
- 3) As long as the bottom is fully supported by the stand the cracks in the bottom will not adversely affect the operation of the kiln.
- 4) The stainless steel clips we use in our lids also help keep these natural cracks from normally becoming a problem in the lids.
- 5) Note that it is possible to put another bottom under the original bottom as a second layer (this can also improve performance and heat up rate of the kiln).
- 6) It generally does not make sense to cement these hairline cracks.
- 7) You can tighten the stainless steel band.

This crack is OK:



TIGHTENING STAINLESS BANDS

- 1) The brick will shrink slightly over time. This is more pronounced when using the kiln at higher temperatures like cone 10. If you only use the kiln for low fire bisque you may never notice this condition.
- 2) If the bricks shrink too much they will become loose.
- 3) Tighten the case by turning the screws of the case clamps. Do this 1/4 of a turn at a time on each of the

clamps. Keep a balanced tightening (i.e don't tighten one clamp too much at one time). Slow is good.

Tightening the bands:

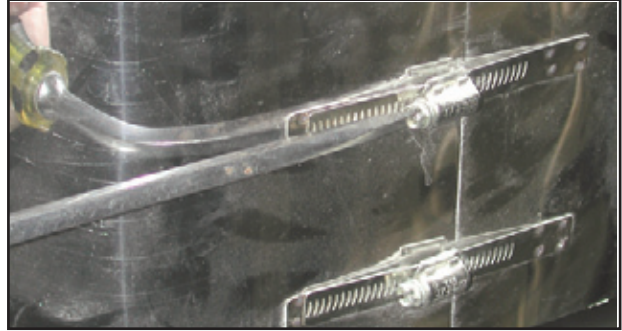

- 4) You can do this on the bands around the top and bottom also. This will help maintain the integrity of those slabs even if there is a crack.

REPLACING FIREBRICK IN SIDES

- 1) If you need to replace a firebrick piece in one of the sections do the following. While it does not require a great deal of experience to accomplish it does take time and patience.
- 2) Order the firebrick precut and prerouted from L&L Kiln. You can order this with the proper element holders already in place or you can reuse the holders from your old brick. Be sure to order it for your specific model kiln. Also, be sure to say whether it is a brick where the element connections come through (because this has different element holders).
- 3) There are no holes drilled in the brick for either peepholes or element connections. This has to be done in the field.
- 4) Take the section off the kiln and put it on a flat surface like a flat floor or table. Elements will have to be removed and probably replaced.
- 5) Loosen up the adjustable clamps that hold the stainless steel wrapping. Loosen them just enough to allow the brick to slide out with slight hand pressure (so that the other bricks stay in place). NOTE: If you don't have the section on a flat surface then the bricks will all come out of proper alignment at this point.

TROUBLESHOOTING AND FIXING BRICK PROBLEMS

6) Slide the bad brick(s) up and out and put in new brick(s). Be sure the element holders line up with the other holders on either side. Note there is a top and a bottom in the element holder so be sure to get the orientation correct.

7) Retighten the clamps on the wrap. Alternately tighten the two or three clamps (about a 1/4 or 1/2 turn at a time) so that you don't cock the stainless casing.

8) Sand off the top surface of the firebrick to match the surface of the other firebricks. Sandpaper will work fine. Reface with Brick Facing.

DRILLING OUT HOLES FOR PEEPHOLES & DAWSON

1) Some of the bricks that you may need to replace will need to have holes drilled in them in the field. These holes can not be drilled in the factory because the alignment would not be perfect.

2) To drill out for peepholes use a 1" diameter drill bit or hole saw. You can also drill with a smaller drill and then file out with a round hasp type file. Drill slowly through the firebrick using the prepunched hole in the stainless steel. You may have to remove the bit several times and clean it out as you drill deeper. It is a good idea to have someone help you by watching from the side to make sure you are drilling straight. It is hard to see this when you are doing the drilling.

3) For sections that have two element rows: the hole is drilled perpendicular to the stainless case.

4) For sections that have three element rows: the hole is not drilled at a perfect 90° perpendicular angle to the kiln case. It will be drilled at a slightly down angle (about 5° to 7°). This is to miss the element holders.

5) Before drilling, as a precaution, you can measure down from the top of the brick to the top of the existing hole in the stainless steel case. This measurement on the inside will show you where the top of the drill bit will protrude. Adjust your angle of drilling accordingly.

Drilling the peephole:



DRILLING OUT FOR THE ELEMENT CONNECTIONS

1) Use a 1/8" to 3/16" diameter drill bit and drill out from the center of the hole in the stainless steel case. Do this slowly with a speed control.

2) Do this perpendicular to the case.

REPLACING BOTTOMS

1) Remove the kiln sections.

2) Take the old bottom off the stand.

3) Put the new bottom on the stand.

4) Relevel the kiln. (This is important).

5) Replace the kiln sections.

NOTE: You may want to experiment with using the old bottom as a secondary back up bottom if it is not too badly damaged. Just make sure it is totally flat so that it doesn't crack the new bottom. Some people find that having this extra insulation thickness helps firing times and bottom uniformity.

TROUBLESHOOTING AND FIXING BRICK PROBLEMS

REPLACING EASY-LIFT LIDS

1) Remove the Hinge Pin and take the old top off the kiln. See the Assembly Instructions for guidance if you have questions about how to do this. Use the Hinge Tool to take the tension off the spring. **BE SURE TO USE SAFETY GLASSES - THERE IS A LOT OF TENSION ON THE SPRING AND INJURY COULD RESULT.**

2) Remove the Top Hinge Part from the old lid. Note that there are three parts to this. There is the main Top Hinge Part. Then there is the Front Hinge Part (the little 3" x 4" aluminized steel plate with a small hole that gets attached to the front of the top with the screws for the Handle). Then there is the Handle. Note that the hole in the Front Hinge Part should be centered around the the little stud that protrudes from the Top Hinge Part.

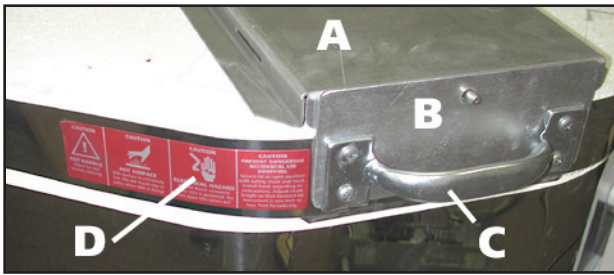

**A= Top Hinge Part, B= Front Hinge Part
C= Handle, D=Label**

3) Using the old top as a guide, install the Top Hinge Part onto the new lid.

4) Reinstall the top and reset the spring. See the Assembly Instructions if you have questions about how to do this.

DURA-FIRE INSTRUCTION MANUAL

**SERVICE
& WARRANTY**



L&L Kiln's patented
hard ceramic
element holders
protect your kiln.

SERVICE FOR L&L KILNS

SERVICE FOR YOUR KILN

L&L kilns are designed to be as easy to work on and fix as possible.

TROUBLESHOOTING GUIDE

Check out the "Support" section of our web site, *hotkilns.com* for all of our troubleshooting references. We are constantly adding to our excellent troubleshooting guides and the web site has the most up-to-date information on it.

YOUR LOCAL DISTRIBUTOR

Call your local distributor, most of whom service the kilns they sell. If they don't they may be able to direct you to a local kiln service person.

OTHER KILN REPAIR PEOPLE

Search for a local kiln service person online or try your local yellow pages. L&L may also be able to recommend a local service person. We maintain a listing of kiln service people around the country. If you can't find a person experienced specifically in kiln repair, then a good electrician is often more than adequate to repair most problems that commonly occur.

REMOVABLE CONTROL PANELS

Some of the more difficult problems occur within the control panel. One of the unique features of the most L&L kilns is the easy ability to remove this panel and send it back to the factory for inspection and/or repair. See the parts list or call the factory.

CONTACT US

Email service@hotkilns.com. Visit: hotkilns.com. Call our office Toll Free at 800-259-1423 (or 856-294-0077) Monday through Friday 8:30 am to 5:00pm Eastern Standard Time. Write to us at L&L Kiln Mfg. Inc. 505 Sharptown Road, Swedesboro, NJ 08085.

WHERE TO BUY PARTS

You can order parts through your local distributor or directly from the factory. L&L stocks almost all parts we sell including elements. We normally ship within one day although some parts do take longer. See the parts list included with these instructions. You can download current parts lists from our web site. A faxable order form is on the parts list.

WHAT WE CAN'T DO

We can not give you advice over the phone on hooking up your kiln to your electrical system. You must have a qualified electrician who can physically see what your specific electrical situation is and who understands any local codes.

SELECTING AN ELECTRICAL CONTRACTOR

A quality electrical contractor:

- 1) Complies with state and local codes and regulations.
- 2) Carries the proper business and workers compensation insurance.
- 3) Is knowledgeable on a wide range of new equipment, technology and design procedures.
- 4) Has a local facility, and is willing to have you visit.
- 5) Is prompt and courteous and provides fast, reliable service -- attempting to perform service at your convenience.
- 6) Is neat and well groomed. This neatness should be reflected in their vehicles and offices as well as their personal appearance.
- 7) Provides a detailed written proposal, clearly outlining the work to be done and the agreed upon cost, including labor and materials. Make sure you understand every word of any contract before you sign it.
- 8) Asks in detail about any problems and offers understandable solutions.

CONSIDER THE FOLLOWING

- 1) Ask for references. Find out if other customers were satisfied. Check with the local Better Business Bureau regarding any filed complaints.
- 2) Compare price. Get bids from a few contractors. Make sure you give each contractor the same specifications and materials needed for the job.
- 3) Remember! How a company treats you now reflects how they will treat you if there's a problem. A quality electrical contractor listens to your problems, understands what you want accomplished and is willing to follow up after the work is completed.

STANDARD LIMITED THREE YEAR WARRANTY FOR L&L KILNS

THREE YEAR LIMITED KILN WARRANTY

L&L Kilns are warranted to be free of defects in workmanship for a period of three (3) years, starting on the date of original purchase from L&L Kiln Mfg., Inc. (L&L) or from an authorized L&L distributor or dealer, subject to the following terms and conditions, including but not limited to, the exclusions and limitations set forth herein.

- 1) A sales receipt is required for proof of purchase.
- 2) In addition, L&L may require you to deliver defective parts to L&L for examination to determine the applicability of these warranty provisions. **DO NOT DISCARD PARTS BEFORE CONTACTING L&L FOR INSTRUCTIONS. FAILURE TO ADHERE TO L&L'S INSTRUCTIONS, INCLUDING THOSE CONTAINED IN THE INSTRUCTION MANUAL AND AS STATED HEREIN, WILL VOID THIS WARRANTY.**
- 3) L&L will replace or repair any defective part that is covered by this warranty and sent freight-prepaid to L&L. L&L will prepay return shipping cost without charge in the Continental United States.
- 4) On-site labor is not part of this warranty and is not covered by L&L. Any warranty labor provided by Dealers and Distributors is provided at their own discretion and expense.

APPLICATION

Applies to Easy-Fire, Easy-Fire XT, eQuad-Pro, Jupiter, DaVinci, Renaissance kilns with DynaTrol, Hercules, Easy-Load, Doll/Test, and Liberty-Belle kilns.

EXCLUSIONS AND LIMITATIONS

The following are examples of items that are not covered by and/or circumstances that will void L&L's warranties:

- 1) Kiln warranty may be voided by firing materials that introduce harmful atmospheres into the kiln. Atmospheres containing carbon, reducing atmospheres (caused, for example, by introducing carbonaceous gasses or solids like graphite or paper into the kiln),

binders from lusters and decals, wax burn out effluents, fluorines, halogens, acids, metal oxides, and salts are some of the corrosive and harmful atmospheres that will damage a kiln. Most ceramic processes will release some of these harmful constituents into the kiln and venting will prevent most of the problems that those processes would cause. Also, depending on the concentration of the harmful gasses, kiln source ventilation (such as our Vent-Sure) may limit the damage to the kiln. It is the customer's sole responsibility to ensure that the materials and the processes used are not harmful. This is of particular importance for industrial uses where processes may be unusual.

- 2) Over-firing damage for any reason and regardless of cause. **IMPORTANT:** We specifically warn you not to fire the kiln unattended. Neither the Dawson Kiln Sitter, The Orton Sitter, the DynaTrol, the Bartlett 3-Button control nor any other electronic control used by L&L is designed to be a failproof shut off device. L&L is not responsible for damage caused by failure of any of these controls.

Also note that it is easy to melt clay if you inadvertently fire it hotter than its rating. It is possible in some controls to limit the upper firing limit of the kiln to avoid accidental overfirings of this type. Contact factory or read your control instruction manual if you would like further information on this.

- 3) Firebrick by its nature is fragile and will chip, crack, and create dust. L&L designs its kilns to minimize the effects of this but can not warrant against cracking, breakage, spalling or dusting. There is specifically no warranty for cracked arches, tops, lids or bottoms.

- 4) The Dawson Kiln Sitter and Orton Sitter controls are warranted by their manufacturers. L&L is not responsible for damage caused by failure of one of these controls.

- 5) Corrosion of the case is specifically not warranted. Corrosion is typically due to use of a kiln in an unheated outside shed (where morning dew condenses on the kiln and humidity attacks the kiln) or from an unvented kiln (where the water vapor and fumes generated by firing ceramic materials attack the kiln case). However, even a vented kiln can corrode due to all the environmental and process conditions that a kiln can be exposed to.

STANDARD LIMITED THREE YEAR WARRANTY FOR L&L KILNS

Exposure to other ambient conditions, including but not limited to rain, snow, dust, and salt air will also cause corrosion.

6) Damage due to neglect, inadequate room or kiln ventilation, mechanical abuse, improper storage, inadequate maintenance, improper use or freight damage.

7) Damage to the elements or element holders due to failure to properly keep the kiln clean (i.e. allowing glaze or ceramic chards from exploding pots) to make contact with the element holders.

8) Damage to the kiln caused for firing in ambient conditions that are too hot for the control or other components in the kiln. The DynaTrol is rated for use up to 125°F (52°C). That means that the room that you fire in should be less than 110°F (43°C) (because the control will be slightly hotter than room air due to transferred heat from the kiln). Note that direct sunlight on the control face may raise the temperature of the board beyond what you would expect from the ambient temperature or the kiln heat. Also note that the DynaTrol specifically allows the operator to check the control board temperature.

9) Failure to report defect within fifteen (15) days after it becomes manifest or known.

10) Any alteration of parts or design that vary from factory designs.

11) Use of elements and/or other parts other than genuine L&L parts supplied by L&L or its authorized Distributors and Dealers.

12) Thermocouple Protection Tubes are not warranted against breakage.

13) L&L's warranty is strictly limited to repair or replacement of defective items. Kilns may not be returned.

14) Distributors and Dealers are not authorized by L&L to modify and/or assume any other obligations or liabilities other than those expressed in this limited warranty and any such additional obligations are null and void.

15) EXCEPT AS SPECIFICALLY WARRANTED HEREIN, KILNS ARE SOLD AS IS. L&L MAKES

NO OTHER WARRANTY, EXPRESS OR IMPLIED, COVERING THE GOODS AND SPECIFICALLY DISCLAIMS ALL IMPLIED WARRANTIES OF MERCHANTABILITY OR FITNESS FOR A PARTICULAR PURPOSE. Purchaser acknowledges that certain conditions or circumstances may be created or incurred by Purchaser or user or over which L&L has no control, including, but not limited to, climactic conditions, improper use, inadequate maintenance, and Purchaser, as a condition of purchase or use, assumes responsibility for and releases L&L from liability arising out of the use of the kilns attributable to such causes.

16) L&L SHALL NOT BE LIABLE FOR ANY INCIDENTAL, SECONDARY, OR CONSEQUENTIAL DAMAGES, INCLUDING BUT NOT LIMITED TO BODILY INJURY OR DEATH, LOST PROFITS, LOSS OF USE, OR OTHER ECONOMIC LOSSES. Purchaser agrees that L&L's total liability for any damages or remedies arising hereunder shall be limited to direct damages, in an amount not exceeding the purchase price actually paid. Replacement or repair or refund, at L&L's sole discretion, of the purchase price of the equipment purchased shall constitute the exclusive and sole remedy available to Purchaser. Any action for breach of contract or negligence must be commenced by Purchase within one (1) year after delivery of the equipment to Purchaser.

17) L&L's full Terms and Conditions of Sale are available at <http://hotkilns.com/standardterms.pdf>.

3 YEAR PRO-RATED ELEMENT & THERMOCOUPLE LIMITED WARRANTY

Elements and thermocouples are warranted for three (3) years on a pro-rated basis with the following exceptions:

1) Glaze damage to the elements caused by accidentally scraping edges of unfired glazed ware against element groove. **WARNING:** causing unfired glaze to contaminate element will damage elements and can lead to element failure, and creates a fire hazard.

2) Firing of kiln to a temperature that exceeds the lower of

a) The maximum rating of kiln

b) 2350°F (1290°C).

STANDARD LIMITED THREE YEAR WARRANTY FOR L&L KILNS

3) Damage to elements caused by explosion of ceramic object. **WARNING:** this may cause damage to the elements and can lead to element failure, and creates a fire hazard.

Following is the pro-rated Schedule for elements and thermocouples:

1) Elements are warranted on a prorated schedule based on the ship date of the kiln. All dates are based on ship date from factory if sold direct or drop shipped to customer. If sold from a distributor's warehouse the date would be based on when it was shipped and/or sold from the distributor. The warranty is not extended for any period of where operation of the kiln is delayed for shipping, warehousing, or other reasons.

2) This replacement schedule is limited to new kilns. L&L does not warrant replacement elements and thermocouples except for catastrophic failure (for instance, a situation where the element end broke off without fault of the operator).

3) Labor to replace elements is not covered.

4) The pro-rated discount schedule only is valid for elements that you are actually replacing. In other words you can't buy a whole set of elements at these prices for anticipated future replacement. We reserve the right to ask for replaced elements in return.

Date from time of shipment from factory	Price of thermocouples and elements
0-12 Months	No Charge
12-24 Months	25% of full list price
24-36 Months	50% of full list price

3 YEAR LIMITED VENT WARRANTY

L&L VS-1 Vent-Sure is warranted to be free of defects in workmanship for a period of (3) years, starting from date of original purchase from L&L Kiln Mfg., Inc. or from an authorized L&L distributor or dealer. A sales receipt is required for proof of purchase. In addition, L&L may require you to send in defective parts for examination to determine the applicability of these warranty provisions. **DO NOT DISCARD PARTS BEFORE CONTACTING L&L.** L&L Kiln Mfg., Inc. will replace or repair any defective part sent

freight-prepaid to L&L Kiln Mfg., Inc. following L&L's written acknowledgement and authorization regarding the specific issue. L&L Kiln Mfg., Inc. will prepay return shipping cost without charge in the Continental United States. On site labor is not covered by the factory; however, local distributors or dealers may offer this service.

EXCLUSIONS & LIMITATIONS

1) The Vent-Sure must be used as instructed in our vent instructions.

2) The use of any wax process that might cause condensation of wax or other similar substance in the vent system will void the warranty.

3) The Vent-Sure is not warranted to vent highly corrosive fumes, and any such use will void any warranties otherwise provided.

3 YEAR LIMITED TRU-VIEW PYROMETER WARRANTY

L&L Tru-View Pyrometer System is warranted to be free of defects in workmanship for a period of (3) years, starting from date of original purchase from L&L Kiln Mfg., Inc. or from an authorized L&L distributor or dealer. A sales receipt is required for proof of purchase. In addition, L&L may require you to send in defective parts for examination to determine the applicability of these warranty provisions. **DO NOT DISCARD PARTS BEFORE CONTACTING L&L.** L&L Kiln Mfg., Inc. will replace or repair any defective part sent freight-prepaid to L&L Kiln Mfg., Inc following L&L's written acknowledgement and authorization regarding the specific issue. L&L Kiln Mfg., Inc. will prepay return shipping cost without charge in the Continental United States.. On site labor is not covered by the factory; however, local distributors may offer this service.

EXCLUSIONS & LIMITATIONS

1) Thermocouples are not warranted for the Tru-View system.

DURA-FIRE INSTRUCTION MANUAL

PARTS



L&L Kiln's patented
hard ceramic
element holders
protect your kiln.

PARTS FOR ALL KILNS (ONLINE DATABASE)

PARTS LIST

A comprehensive and up-to-date listing of parts that pertain to all Kiln Series' built by L&L Kiln Mfg., Inc. can now be found on our website at, <http://hotkilns.com/parts>

Use the "Kiln Series" Parts Filter to narrow down the list of available parts to those that pertain to your specific kiln.

If further brevity is desired, use the "Category" Parts Filter as well.

DURA-FIRE INSTRUCTION MANUAL

MSDS SHEETS

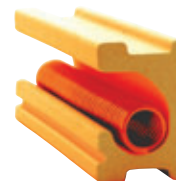

L&L Kiln's patented
hard ceramic
element holders
protect your kiln.

L&L KILN COMPONENTS MATERIAL SAFETY DATA SHEETS

TABLE OF CONTENTS

STANDARD KILN COMPONENTS	2
KASIL® 6.....	2
REFRACTORY BRICK.....	7
REFRACTORY MORTAR.....	13
REPAIR KIT CEMENT	19
GREENSET-94-P.....	19
KILN WASH COMPONENTS	25
6-TILE KAOLIN CLAY	25
ALUMINUM HYDROXIDE.....	29
HALTEX® 315.....	33
KAOLIN SLURRY	35
SILICA SAND.....	41
ADDITIONAL INSULATION (DEPENDENT ON KILN).....	48
INSBLOK-19.....	48
INSULFRAX® INSULATION	55
ISOFRAX® 1260C PAPER.....	62
MINWOOL-1200™ BOARD	69
TADPOLE SILICA FABRIC	75
THERMO-12® GOLD INSULATION	87

Trade Name: **KASIL® 6 Potassium Silicate Solution**

Date Prepared: 07/26/06

Page: 1 of 5

1. CHEMICAL PRODUCT AND COMPANY IDENTIFICATION

Product name: **KASIL® 6 Potassium silicate solution**
Product description: **A 2.10 weight ratio potassium silicate, 39.2% solution in water**
Manufacturer: **PQ Corporation**
P. O. Box 840
Valley Forge, PA 19482 USA
Telephone: **610-651-4200**
In case of emergency call: **610-651-4200**
For transportation emergency
Call CHEMTREC: **800-424-9300**

2. COMPOSITION/INFORMATION ON INGREDIENTS

<i>Chemical and Common Name</i>	<i>CAS Registry Number</i>	<i>Wt. %</i>	<i>OSHA PEL</i>	<i>ACGIH TLV</i>
Water	7732-18-5	60.8%	Not Established	Not Established
Silicic acid, potassium salt; Potassium silicate	1312-76-1	39.2%	Not Established	Not Established

3. HAZARDS IDENTIFICATION

Emergency Overview: **Clear to hazy, colorless, odorless, thick liquid. Causes moderate eye irritation, slight skin irritation and digestive tract irritation. Spray mist causes irritation to respiratory tract. High pH of product is harmful to aquatic life. Noncombustible. Spills are slippery. Reacts with acids, ammonium salts, reactive metals and some organics.**

Eye contact: **Causes moderate irritation to the eyes.**

Skin contact: **Causes slight irritation to the skin.**

Inhalation: **Spray mist irritating to respiratory tract.**

Ingestion: **May cause irritation to mouth, esophagus, and stomach.**

Chronic hazards: **No known chronic hazards. Not listed by NTP, IARC or OSHA as a carcinogen.**

Physical hazards: **Dries to form glass film which can easily cut skin. Spilled material is very slippery. Can etch glass if not promptly removed.**

4. FIRST AID MEASURES

Eye: **In case of contact, immediately flush eyes with plenty of water for at least 15 minutes. Get medical attention.**

Skin: **In case of contact, immediately flush skin with plenty of water. Remove contaminated clothing and shoes. Get medical attention.**

Inhalation: **Remove to fresh air. If not breathing, give artificial respiration. If breathing is difficult, give oxygen. Get medical attention.**

Ingestion: If swallowed, **DO NOT** induce vomiting. Get medical attention immediately. If victim is fully conscious, give a cupful of water. Never give anything by mouth to an unconscious person.

5. FIRE FIGHTING MEASURES

Flammable limits: This material is noncombustible.
Extinguishing Media: This material is compatible with all extinguishing media.
Hazards to fire-fighters: See Section 3 for information on hazards when this material is present in the area of a fire.
Fire-fighting equipment: The following protective equipment for fire fighters is recommended when this material is present in the area of a fire: chemical goggles, body-covering protective clothing, chemical resistant gloves, and rubber boots.

6. ACCIDENTAL RELEASE MEASURES

Personal protection: Wear chemical goggles, body-covering protective clothing, chemical resistant gloves, and rubber boots. See section 8.
Environmental Hazards: Sinks and mixes with water. High pH of this material is harmful to aquatic life, see Section 12. Only water will evaporate from a spill of this material.
Small spill cleanup: Mop up and neutralize liquid, then discharge to sewer in accordance with federal, state and local regulations or permits.
Large spill cleanup: Keep unnecessary people away; isolate hazard area and deny entry. Do not touch or walk through spilled material. Stop leak if you can do so without risk. Prevent runoff from entering into storm sewers and ditches which lead to natural waterways. Isolate, dike and store discharged material, if possible. Use sand or earth to contain spilled material. If containment is impossible, neutralize contaminated area and flush with large quantities of water.
CERCLA RQ: There is no CERCLA Reportable Quantity for this material. If a spill goes off site, notification of state and local authorities is recommended.

7. HANDLING AND STORAGE

Handling: Avoid contact with eyes, skin and clothing. Avoid breathing spray mist. Keep container closed. Promptly clean residue from closures with cloth dampened with water. Promptly clean up spills.
Storage: Keep containers closed. Store in clean steel or plastic containers. Separate from acids, reactive metals, and ammonium salts. Storage temperature 0-95° C. Loading temperature 45-95 ° C. Do not store in aluminum, fiberglass, copper, brass, zinc or galvanized containers.

8. EXPOSURE CONTROLS/PERSONAL PROTECTION

<i>Engineering controls:</i>	Use with adequate ventilation. Keep containers closed. Safety shower and eyewash fountain should be within direct access.
<i>Respiratory protection:</i>	Use a NIOSH-approved dust and mist respirator where spray mist occurs. Observe OSHA regulations for respirator use (29 C.F.R. §1910.134)
<i>Skin protection:</i>	Wear body-covering protective clothing and gloves.
<i>Eye protection:</i>	Wear chemical goggles.

9. PHYSICAL AND CHEMICAL PROPERTIES

<i>Appearance:</i>	Thick liquid.
<i>Color:</i>	Clear to hazy white.
<i>Odor:</i>	Odorless or musty odor.
<i>pH:</i>	Approximately 11.7
<i>Specific gravity:</i>	1.39 g/cm ₃ (20°C), 40.4° Bé, 11.56 lbs/gal
<i>Solubility in water:</i>	Miscible.

10. STABILITY AND REACTIVITY

<i>Stability:</i>	This material is stable under all conditions of use and storage.
<i>Conditions to avoid:</i>	None.
<i>Materials to avoid:</i>	Gels and generates heat when mixed with acid. May react with ammonium salts resulting in evolution of ammonia gas. Flammable hydrogen gas may be produced on contact with aluminum, tin, lead, and zinc.
<i>Hazardous decomposition products:</i>	Hydrogen.

11. TOXICOLOGICAL INFORMATION

<i>Acute Data:</i>	When tested for primary irritation potential, this material caused moderate irritation to the eyes and slight irritation to the skin. Human experience indicates that irritation occurs when potassium silicates get on clothes at the collar, cuffs or other areas where abrasion may occur. The acute oral toxicity of this product has not been tested. When chemically similar sodium silicates were tested on a 100% solids basis, their single dose acute oral LD ₅₀ in rats ranged from 1500 mg/kg to 3200 mg/kg. The acute oral lethality resulted from nonspecific causes. This product contains approximately 39.2% potassium silicate.
<i>Subchronic Data:</i>	The subchronic toxicity of this material has not been tested. In a study of rats fed chemically similar sodium silicate in drinking water for three months, at 200, 600 and 1800 ppm, changes were reported in the blood chemistry of some animals, but no specific changes to the organs of the animals due to potassium silicate administration were observed in any of the dosage groups. Another study reported adverse effects to the kidneys of dogs fed potassium silicate in their diet at 2.4g/kg/day for 4 weeks,

Special Studies: whereas rats fed the same dosage did not develop any treatment-related effects. Decreased numbers of births and survival to weaning was reported for rats fed sodium silicate in their drinking water at 600 and 1200 ppm.
The mutagenic potential of this material has not been tested. Chemically similar sodium silicate was not mutagenic to the bacterium E. Coli when tested in a mutagenicity bioassay. There are no known reports of carcinogenicity of potassium silicates. Frequent ingestion over extended periods of time of gram quantities of silicates is associated with the formation kidney stones and other siliceous urinary calculi in humans. Potassium silicate is not listed by IARC, NTP or OSHA as a carcinogen.

12. ECOLOGICAL INFORMATION

Ecotoxicity: The ecotoxicity of potassium silicate has not been tested. The following data is reported for chemically similar sodium silicates on a 100% solids basis: A 96 hour median tolerance for fish (*Gambusia affinis*) of 2320 ppm; a 96 hour median tolerance for water fleas (*Daphnia magna*) of 247 ppm; a 96 hour median tolerance for snail eggs (*Lymnea*) of 632 ppm; and a 96 hour median tolerance for Amphipoda of 160 ppm. This product contains approximately 39.2% potassium silicate.

Environmental Fate: This material is not persistent in aquatic systems, but its high pH when undiluted or unneutralized is acutely harmful to aquatic life. Diluted material rapidly depolymerizes to yield dissolved silica in a form that is indistinguishable from natural dissolved silica. It does not contribute to BOD. This material does not bioaccumulate except in species that use silica as a structural material such as diatoms and siliceous sponges. Where abnormally low natural silica concentrations exist (less than 0.1 ppm), dissolved silica may be a limiting nutrient for diatoms and a few other aquatic algal species. However, the addition of excess dissolved silica over the limiting concentration will not stimulate the growth of diatom populations; their growth rate is independent of silica concentration once the limiting concentration is exceeded. Neither silica nor potassium will appreciably bioconcentrate up the food chain.

Physical/Chemical: Sinks and mixes with water. Only water will evaporate from this material.

13. DISPOSAL CONSIDERATIONS

Classification: Disposed material is not a RCRA Hazardous waste.
Disposal Method: Dispose in accordance with federal, state and local regulations and permits.

14. TRANSPORT INFORMATION

DOT UN Status: This material is not regulated hazardous material for transportation.

Trade Name: **KASIL® 6 Potassium Silicate Solution**
Date Prepared: 07/26/06

Page: 5 of 5

15. REGULATORY INFORMATION

CERCLA: No CERCLA Reportable Quantity has been established for this material.
SARA TITLE III: Not an Extremely Hazardous Substance under §302. Not a Toxic Chemical under §313. Hazard Categories under §§311/312: Acute
TSCA: All ingredients of this material are listed on the TSCA inventory.
FDA: Potassium silicate is regarded as GRAS (Generally Recognized As Safe) as a corrosion preventative in potable water.

16. OTHER INFORMATION

Prepared by: John G. Blumberg
Supersedes revision of: 03/24/06

THE INFORMATION ON THIS SAFETY DATA SHEET IS BELIEVED TO BE ACCURATE AND IT IS THE BEST INFORMATION AVAILABLE TO PQ CORPORATION THIS DOCUMENT IS INTENDED ONLY AS A GUIDE TO THE APPROPRIATE PRECAUTIONS FOR HANDLING A CHEMICAL BY A PERSON TRAINED IN CHEMICAL HANDLING. PQ CORPORATION MAKES NO WARRANTY OF MERCHANTABILITY OR ANY OTHER WARRANTY, EXPRESS OR IMPLIED WITH RESPECT TO SUCH INFORMATION OR THE PRODUCT TO WHICH IT RELATES, AND WE ASSUME NO LIABILITY RESULTING FROM THE USE OR HANDLING OF THE PRODUCT TO WHICH THIS SAFETY DATA SHEET RELATES. USERS AND HANDLERS OF THIS PRODUCT SHOULD MAKE THEIR OWN INVESTIGATIONS TO DETERMINE THE SUITABILITY OF THE INFORMATION PROVIDED HEREIN FOR THEIR OWN PURPOSES.



MATERIAL SAFETY DATA SHEET

MSDS No: 151-1

Date Prepared: 03/28/1995

Current Date: 9/14/2007

Last Revised: (09/14/2007)

1. PRODUCT AND COMPANY IDENTIFICATION

Product Group: INSULATING REFRACTORY BRICK
Chemical Name: Aluminosilicate Product
Intended Use: High Temperature Thermal Insulation
Trade Names: K-20, K-22 HS, K-23, JM-20, JM-23, K-24 HS, K-25, K-26, IFB Dust (Low Temp), TC-23, TC-23 HS

Manufacturer/Supplier: Thermal Ceramics Inc.
 P. O. Box 923; Dept. 300
 Augusta, GA 30903-0923

For Product Stewardship and Emergency Information -
 Hotline: 1-800-722-5681
 Fax: 706-560-4054

For additional MSDSs and to confirm this is the most current MSDS for the product, visit our web page [www.thermalceramics.com]

2. COMPOSITION/INFORMATION ON INGREDIENTS

<u>INGREDIENT & CAS NUMBER</u>	<u>% BY WEIGHT</u>	<u>OSHA PEL</u>	<u>ACGIH TLV</u>
Anorthite NONE	Up to 70	15 mg/m ³ (total dust) 5 mg/m ³ (respirable dust)	10 mg/m ³ (inhalable dust) 3 mg/m ³ (respirable dust)
Glass 65997-17-3	Up to 30	15 mg/m ³ (total dust) 5 mg/m ³ (respirable dust)	10 mg/m ³ (inhalable dust) 3 mg/m ³ (respirable dust)
Mullite 1344-28-1	Up to 20	15 mg/m ³ (total dust) 5 mg/m ³ (respirable dust)	10 mg/m ³ (inhalable dust) 3 mg/m ³ (respirable dust)
Crystalline silica 14808-60-7 or 14464-46-1	Up to 5	See notes ⁽¹⁾	0.05 mg/m ³ (respirable dust)

NOTES:

⁽¹⁾ Depending on the percentage and type(s) of silica in the mineral, the OSHA Permissible Exposure Limit (PEL) for respirable dust containing crystalline silica (8 HR TWA) is based on the formula listed in 29 CFR 1910.1000, "Air Contaminants" under Table Z-3, "Mineral Dust". For quartz containing mineral dust, the PEL = 10 mg/m³ / (% of silica + 2); for cristobalite or tridymite, the PEL = 5 mg/m³ / (% of silica + 2); for mixtures, the PEL = 10 mg/m³ / (% of quartz + 2 (% of cristobalite) + 2 (% of tridymite) + 2).

(See Section 8 "Exposure Controls / Personal Protection" for exposure guidelines.)

MSDS No: 151-1

Date Prepared: 03/28/1995

Current Date: 9/14/2007

Last Revised: (09/14/2007)

3. HAZARDS IDENTIFICATION

EMERGENCY OVERVIEW

WARNING!

Respirable dust from these products may contain crystalline silica, which is known to cause respiratory disease.
(See Section 11 for more information)

POSSIBLE HEALTH EFFECTS

Target Organs: Eyes, skin, nose and/or throat

Primary Entry Route: Inhalation

Acute effects: May cause temporary, mild mechanical irritation to the eyes, skin, nose and/or throat. Pre-existing skin and respiratory conditions may be aggravated by exposure.

Chronic effects: Prolonged/repeated inhalation of respirable crystalline silica may cause delayed lung injury (e.g.: silicosis, lung cancer).

HAZARD CLASSIFICATION

Dust samples from these products have not been tested for their specific toxicity, but may contain more than 0.1% crystalline silica, for which the following apply:

The **International Agency for Research on Cancer (IARC)** has classified crystalline silica inhaled in the form of quartz or cristobalite from occupational sources as carcinogenic to humans (Group 1).

The Ninth Annual Report on Carcinogens (2000), prepared by the **National Toxicology Program (NTP)**, classified silica, crystalline (respirable size), as a substance known to be a human carcinogen.

The **American Conference of Governmental Industrial Hygienists (ACGIH)** has classified crystalline silica (quartz) as "A2-Suspected Human Carcinogen."

The **State of California**, pursuant to Proposition 65, The Safe Drinking Water and Toxic Enforcement Act of 1986, has listed "silica, crystalline (airborne particles of respirable size)" as a chemical known to the State of California to cause cancer.

The **Canadian Workplace Hazardous Materials Information System (WHMIS)** – Crystalline silica [quartz and cristobalite] is classified as Class D2A - Materials Causing Other Toxic Effects.

The **Hazardous Materials Identification System (HMIS)** –

Health: 0* Flammability: 0 Reactivity: 0 Personal Protection Index: X (Employer determined)

(* denotes potential for chronic effects)

4. FIRST AID MEASURES

EYE IRRITATION:

Flush with large amounts of water for at least 15 minutes. Do not rub eyes.

SKIN IRRITATION:

Wash affected area gently with soap and water. Skin cream or lotion after washing may be helpful.

INGESTION:

Unlikely route of exposure.

INHALATION:

Remove affected person to dust free location. See Section 8 for additional measures to reduce or eliminate exposure.

- If symptoms persist, seek medical attention. -

MSDS No: 151-1

Date Prepared: 03/28/1995

Current Date: 9/14/2007

Last Revised: (09/14/2007)

5. FIRE FIGHTING MEASURES

NFPA CODES: Flammability: 0, Health: 1, Reactivity: 0, Special: 0
NFPA Unusual Hazards: None
Flash Point: None
Extinguishing Media: Use extinguishing media suitable for type of surrounding fire.
Explosion Hazards: None
Hazardous Decomposition Products: None

6. ACCIDENTAL RELEASE MEASURES

SPILL/LEAK PROCEDURES:

Avoid creating airborne dust. Follow routine housekeeping procedures. Vacuum only with HEPA filtered equipment. If sweeping is necessary, use a dust suppressant and place material in closed containers. Do not use compressed air for clean-up. Personnel should wear gloves, goggles and approved respirator.

7. HANDLING AND STORAGE

HANDLING

Limit the use of power tools unless in conjunction with local exhaust. Use hand tools whenever possible. Frequently clean the work area with HEPA filtered vacuum or wet sweeping to minimize the accumulation of debris. Do not use compressed air for clean-up.

STORAGE

Store in original factory container in a dry area. Keep container closed when not in use.

EMPTY CONTAINERS

Product packaging may contain residue. Do not reuse.

8. EXPOSURE CONTROLS/PERSONAL PROTECTION

ENGINEERING CONTROLS

Use engineering controls, such as ventilation and dust collection devices, to reduce airborne particulate concentrations to the lowest attainable level.

RESPIRATORY PROTECTION

When it is not possible or feasible to reduce airborne crystalline silica or particulate levels below the PEL through engineering controls, or until they are installed, employees are encouraged to use good work practices together with respiratory protection. Before providing respirators to employees (especially negative pressure type), employers should **1) monitor for airborne crystalline silica and/or dust concentrations using appropriate NIOSH analytical methods and select respiratory protection based upon the results of that monitoring,** **2) have the workers evaluated by a physician to determine the workers' ability to wear respirators, and 3) implement respiratory protection training programs.** Use NIOSH-certified particulate respirators (42 CFR 84), in compliance with OSHA Respiratory Protection Standard 29 CFR 1910.134 and 29 CFR 1926.103, for the particular hazard or airborne concentrations to be encountered in the work environment. For the most current information on respirator selection, contact your supplier.

PROTECTIVE CLOTHING

Wear full body clothing, gloves, hat, and eye protection as necessary to prevent skin irritation. Washable or disposable clothing may be used. If possible, do not take unwashed work clothing home. If soiled work clothing must be taken home, employers should ensure employees are trained on the best practices to minimize or avoid non-work dust exposure (e.g., vacuum clothes before leaving the work area, wash work clothing separately, rinse washer before washing other household clothes, etc.).

EYE PROTECTION

MSDS No: 151-1

Date Prepared: 03/28/1995

Current Date: 9/14/2007

Last Revised: (09/14/2007)

Wear safety glasses with side shields or other forms of eye protection in compliance with appropriate OSHA standards to prevent eye irritation. The use of contact lenses is not recommended, unless used in conjunction with appropriate eye protection. Do not touch eyes with soiled body parts or materials. If possible, have eye-washing facilities readily available where eye irritation can occur.

9. PHYSICAL AND CHEMICAL PROPERTIES

ODOR AND APPEARANCE:	Solid brick or block
CHEMICAL FAMILY:	Insulating refractory brick
BOILING POINT:	Not applicable
WATER SOLUBILITY (%):	Not soluble in water
MELTING POINT:	2750°F to 2800°F
SPECIFIC GRAVITY:	Not applicable
VAPOR PRESSURE:	Not applicable
pH:	Not applicable
VAPOR DENSITY:	Not applicable
VOLATILE BY VOLUME (%):	Not applicable
MOLECULAR FORMULA:	Not Applicable

10. STABILITY AND REACTIVITY

HAZARDOUS POLYMERIZATION:	Will not occur
CHEMICAL INCOMPATIBILITIES:	Powerful oxidizers; fluorine, manganese trioxide, oxygen disulfide
HAZARDOUS DECOMPOSITION PRODUCTS:	None

11. TOXICOLOGICAL INFORMATION

TOXICOLOGY

Dust samples from these products have not been tested. They may contain respirable crystalline silica.

Crystalline silica

Some samples of crystalline silica administered to rats by inhalation and intratracheal instillation have caused fibrosis and lung cancer. Mice and hamsters, similarly exposed, develop inflammatory disease including fibrosis but no lung cancer.

EPIDEMIOLOGY

No studies have been undertaken on humans exposed to these products in occupational environments.

Crystalline silica

Exposure to crystalline silica can cause silicosis, and exacerbate pulmonary tuberculosis and bronchitis. IARC (Monograph vol. 68, 1997) concluded that "crystalline silica from occupational sources inhaled in the form of quartz or cristobalite is carcinogenic to humans (Group 1)", and noted that "carcinogenicity in humans was not detected in all industrial circumstances studied" and "may be dependent on inherent characteristics of the crystalline silica or on external factors affecting its biological activity".

12. ECOLOGICAL INFORMATION

Adverse effects of this material on the environment are not anticipated.

MSDS No: 151-1

Date Prepared: 03/28/1995

Current Date: 9/14/2007

Last Revised: (09/14/2007)

13. DISPOSAL INFORMATION

WASTE MANAGEMENT

To prevent waste materials becoming airborne during waste storage, transportation and disposal, a covered container or plastic bagging is recommended. Comply with federal, state and local regulations.

DISPOSAL

If discarded in its purchased form, this product would not be a hazardous waste under Federal regulations (40 CFR 261). Any processing, use, alteration or chemical additions to the product, as purchased, may alter the disposal requirements. Under Federal regulations, it is the waste generator's responsibility to properly characterize a waste material, to determine if it is a hazardous waste. Check local, regional, state or provincial regulations to identify all applicable disposal requirements.

14. TRANSPORT INFORMATION

U.S. DEPARTMENT OF TRANSPORTATION (DOT)

Hazard Class:	Not Regulated	United Nations (UN) Number:	Not Applicable
Labels:	Not Applicable	North America (NA) Number:	Not Applicable
Placards:	Not Applicable	Bill of Lading:	Product Name

INTERNATIONAL

Canadian TDG Hazard Class & PIN: Not regulated
Not classified as dangerous goods under ADR (road), RID (train) or IMDG (ship).

15. REGULATORY INFORMATION

UNITED STATES REGULATIONS

SARA Title III: This product does not contain any substances reportable under Sections 302, 304, 313 (40 CFR 372). Sections 311 and 312 apply.

OSHA: Comply with Hazard Communication Standards 29 CFR 1910.1200 and 29 CFR 1926.59 and Respiratory Protection Standards 29 CFR 1910.134 and 29 CFR 1926.103.

TSCA: All substances contained in this product are listed in the TSCA Chemical Inventory

California: "Silica, crystalline (airborne particles of respirable size)" is listed in Proposition 65, The Safe Drinking Water and Toxic Enforcement Act of 1986 as a chemical known to the State of California to cause cancer.

Other States: Crystalline silica products are not known to be regulated by states other than California; however, state and local OSHA and EPA regulations may apply to these products. Contact your local agency if in doubt.

INTERNATIONAL REGULATIONS

Canadian WHMIS: Class D-2A Materials Causing Other Toxic Effects

Canadian EPA: All substances in this product are listed, as required, on the Domestic Substance List (DSL).

16. OTHER INFORMATION

SARA TITLE III HAZARD CATEGORIES

Acute Health:	No	Pressure Hazard:	No
Chronic Health:	Yes	Reactivity Hazard:	No
Fire Hazard:	No		

MSDS No: 151-1

Date Prepared: 03/28/1995

Current Date: 9/14/2007

Last Revised: (09/14/2007)

DEFINITIONS:

ACGIH:	American Conference of Governmental Industrial Hygienists
ADR:	Carriage of Dangerous Goods by Road (International Regulation)
CAA:	Clean Air Act
CAS:	Chemical Abstracts Service Registry Number
CERCLA:	Comprehensive Environmental Response, Compensation and Liability Act
EPA:	Environmental Protection Agency
EU:	European Union
f/cc:	Fibers per cubic centimeter
HEPA:	High Efficiency Particulate Air
HMIS:	Hazardous Materials Identification System
IARC:	International Agency for Research on Cancer
IATA:	International Air Transport Association
IMDG:	International Maritime Dangerous Goods Code
mg/m³ :	Milligrams per cubic meter of air
mppcf:	Million particles per cubic meter
MSHA:	Mine Safety and Health Administration
NFPA:	National Fire Protection Association
NIOSH:	National Institute for Occupational Safety and Health
OSHA:	Occupational Safety and Health Administration
PEL:	Permissible Exposure Limit
PNOC:	Particulates Not Otherwise Classified
PNOR:	Particulates Not Otherwise Regulated
RCRA:	Resource Conservation and Recovery Act
RID:	Carriage of Dangerous Goods by Rail (International Regulation)
SARA:	Superfund Amendments and Reauthorization Act
Title III:	Emergency Planning and Community Right to Know Act
...Section 302:	Extremely Hazardous Substances
...Section 304:	Emergency Release
...Section 311:	MSDS/List of Chemicals
...Section 312:	Emergency and Hazardous Inventory
...Section 313:	Toxic Chemicals Release Reporting
STEL:	Short-Term Exposure Limit
TCLP:	Toxicity Characteristics Leaching Procedures (EPA)
TLV:	Threshold Limit Values (ACGIH)
TSCA:	Toxic Substance Control Act
WHMIS:	Workplace Hazardous Materials Information System (Canada)
29 CFR 1910.134 & 1926.103:	OSHA Respiratory Protection Standards
29 CFR 1910.1200 & 1926.59:	OSHA Hazard Communication Standards

Revision Summary: MSDS revision date updated.

MSDS Prepared By: THERMAL CERAMICS ENVIRONMENTAL, HEALTH & SAFETY DEPARTMENT

DISCLAIMER

The information presented herein is presented in good faith and believed to be accurate as of the effective date of this Material Safety Data Sheet. Employers may use this MSDS to supplement other information gathered by them in their efforts to assure the health and safety of their employees and the proper use of the product. This summary of the relevant data reflects professional judgment; employers should note that information perceived to be less relevant has not been included in this MSDS. Therefore, given the summary nature of this document, Thermal Ceramics does not extend any warranty (expressed or implied), assume any responsibility, or make any representation regarding the completeness of this information or its suitability for the purposes envisioned by the user.



MATERIAL SAFETY DATA SHEET

MSDS No: 141

Date Prepared: 05/01/1987

Current Date: 4/12/2006

Last Revised: (04/10/2006)

1. PRODUCT AND COMPANY IDENTIFICATION

Product Group: REFRACTORY MORTAR
Chemical Name: Aluminosilicate Product
Intended Use: High Temperature Thermal Insulation
Trade Names: Air-Set™ (Dry, Wet); Smooth-Set (Dry, Wet); High Temp: IFB (Dry, Wet); SR®-90 Dry; Mul-Set™ F (Dry, Wet); Unistik® A; K®-Bond (Dry, Wet); Cements; Cer-Flex® Mortars

Manufacturer/Supplier: Thermal Ceramics Inc.
P. O. Box 923; Dept. 300
Augusta, GA 30903-0923

For Product Stewardship and Emergency Information -
Hotline: 1-800-722-5681
Fax: 706-560-4054

For additional MSDSs and to confirm this is the most current MSDS for the product, visit our web page [www.thermalceramics.com].

2. COMPOSITION/INFORMATION ON INGREDIENTS

<u>INGREDIENT & CAS NUMBER</u>	<u>% BY WEIGHT</u>	<u>OSHA PEL</u>	<u>ACGIH TLV</u>
Aluminum silicate 1302-76-7	Up to 52	15 mg/m ³ (total dust); 5 mg/m ³ (respirable dust)	10 mg/m ³ (inhalable dust) 3 mg/m ³ (respirable dust)
Aluminum oxide 1344-28-1	Up to 50	15 mg/m ³ (total dust); 5 mg/m ³ (respirable dust)	10 mg/m ³
Silica, amorphous 7631-86-9	Up to 40	(80 mg/m ³ ÷ % SiO ₂) or 20 mppcf	10 mg/m ³
Kaolin 1332-58-7	Up to 27	15 mg/m ³	2 mg/m ³ (respirable dust)
Crystalline silica 14808-60-7 or 14464-46-1	Up to 20	See notes ⁽¹⁾	0.05 mg/m ³ (respirable dust)
Water 7732-18-5	0 to 11	Not established	Not established
Borate, tetra, sodium salt, decahydrate 1303-96-4	0 to 2	15 mg/m ³ (total dust); 5 mg/m ³ (respirable dust)	5 mg/m ³

MSDS No: 141

Date Prepared: 05/01/1987

Current Date: 4/12/2006

Last Revised: (04/10/2006)

NOTES:

⁽¹⁾ Depending on the percentage and type(s) of silica in the mineral, the OSHA Permissible Exposure Limit (PEL) for respirable dust containing crystalline silica (8 HR TWA) is based on the formula listed in 29 CFR 1910.1000, "Air Contaminants" under Table Z-3, "Mineral Dust". For quartz containing mineral dust, the PEL = 10 mg/m³ / (% of silica + 2); for cristobalite or tridymite, the PEL = 5 mg/m³ / (% of silica + 2); for mixtures, the PEL = 10 mg/m³ / (% of quartz + 2 (% of cristobalite) + 2 (% of tridymite) + 2).

(See Section 8 "Exposure Controls / Personal Protection" for exposure guidelines.)

3. HAZARDS IDENTIFICATION

EMERGENCY OVERVIEW

WARNING!

Respirable dust from these products may contain crystalline silica, which is known to cause respiratory disease.
(See Section 11 for more information)

POSSIBLE HEALTH EFFECTS

Target Organs: Eyes, skin, nose and/or throat
Primary Entry Route: Inhalation
Acute effects: May cause temporary, mild mechanical irritation to the eyes, skin, nose and/or throat. Pre-existing skin and respiratory conditions may be aggravated by exposure.
Chronic effects: Prolonged/repeated inhalation of respirable crystalline silica may cause delayed lung injury (e.g.: silicosis, lung cancer).

HAZARD CLASSIFICATION

Dust samples from these products have not been tested for their specific toxicity, but may contain more than 0.1% crystalline silica, for which the following apply:

The **International Agency for Research on Cancer (IARC)** has classified crystalline silica inhaled in the form of quartz or cristobalite from occupational sources as carcinogenic to humans (Group 1).

The Ninth Annual Report on Carcinogens (2000), prepared by the **National Toxicology Program (NTP)**, classified silica, crystalline (respirable size), as a substance known to be a human carcinogen.

The **American Conference of Governmental Industrial Hygienists (ACGIH)** has classified crystalline silica (quartz) as "A2-Suspected Human Carcinogen."

The **State of California**, pursuant to Proposition 65, The Safe Drinking Water and Toxic Enforcement Act of 1986, has listed "silica, crystalline (airborne particles of respirable size)" as a chemical known to the State of California to cause cancer.

The **Canadian Workplace Hazardous Materials Information System (WHMIS)** – Crystalline silica [quartz and cristobalite] is classified as Class D2A - Materials Causing Other Toxic Effects.

The **Hazardous Materials Identification System (HMIS)** –
Health: 1* Flammability: 0 Reactivity: 0 Personal Protection Index: X (Employer determined)
(* denotes potential for chronic effects)

4. FIRST AID MEASURES

EYE IRRITATION:

Flush with large amounts of water for at least 15 minutes. Do not rub eyes.

SKIN IRRITATION:

Wash affected area gently with soap and water. Skin cream or lotion after washing may be helpful.

MSDS No: 141

Date Prepared: 05/01/1987

Current Date: 4/12/2006

Last Revised: (04/10/2006)

INGESTION:

Unlikely route of exposure.

INHALATION:

Remove affected person to dust free location. See Section 8 for additional measures to reduce or eliminate exposure.

- If symptoms persist, seek medical attention. -

5. FIRE FIGHTING MEASURES

NFPA CODES: Flammability: 0, Health: 1, Reactivity: 0, Special: 0

NFPA Unusual Hazards: None

Flash Point: None

Extinguishing Media: Use extinguishing media suitable for type of surrounding fire.

Explosion Hazards: None

Hazardous Decomposition Products: None

6. ACCIDENTAL RELEASE MEASURES

SPILL/LEAK PROCEDURES:

Avoid creating airborne dust. Follow routine housekeeping procedures. Vacuum only with HEPA filtered equipment. If sweeping is necessary, use a dust suppressant and place material in closed containers. Do not use compressed air for clean-up. Personnel should wear gloves, goggles and approved respirator.

7. HANDLING AND STORAGE

HANDLING

Limit the use of power tools unless in conjunction with local exhaust. Use hand tools whenever possible. Frequently clean the work area with HEPA filtered vacuum or wet sweeping to minimize the accumulation of debris. Do not use compressed air for clean-up.

STORAGE

Store in original factory container in a dry area. Keep container closed when not in use.

EMPTY CONTAINERS

Product packaging may contain residue. Do not reuse.

8. EXPOSURE CONTROLS/PERSONAL PROTECTION

ENGINEERING CONTROLS

Use engineering controls, such as ventilation and dust collection devices, to reduce airborne particulate concentrations to the lowest attainable level.

RESPIRATORY PROTECTION

When it is not possible or feasible to reduce airborne crystalline silica or particulate levels below the PEL through engineering controls, or until they are installed, employees are encouraged to use good work practices together with respiratory protection. Before providing respirators to employees (especially negative pressure type), employers should **1) monitor for airborne crystalline silica and/or dust concentrations using appropriate NIOSH analytical methods and select respiratory protection based upon the results of that monitoring, 2) have the workers evaluated by a physician to determine the workers' ability to wear respirators, and 3) implement respiratory protection training programs.** Use NIOSH-certified particulate respirators (42 CFR 84), in compliance with OSHA Respiratory Protection Standard 29 CFR 1910.134 and 29 CFR 1926.103, for the particular hazard or airborne concentrations to be encountered in the work environment. For the most current information on respirator selection, contact your supplier.

MSDS No: 141

Date Prepared: 05/01/1987

Current Date: 4/12/2006

Last Revised: (04/10/2006)

PROTECTIVE CLOTHING

Wear full body clothing, gloves, hat, and eye protection as necessary to prevent skin irritation. Washable or disposable clothing may be used. If possible, do not take unwashed work clothing home. If soiled work clothing must be taken home, employers should ensure employees are trained on the best practices to minimize or avoid non-work dust exposure (e.g., vacuum clothes before leaving the work area, wash work clothing separately, rinse washer before washing other household clothes, etc.).

EYE PROTECTION

Wear safety glasses with side shields or other forms of eye protection in compliance with appropriate OSHA standards to prevent eye irritation. The use of contact lenses is not recommended, unless used in conjunction with appropriate eye protection. Do not touch eyes with soiled body parts or materials. If possible, have eye-washing facilities readily available where eye irritation can occur.

9. PHYSICAL AND CHEMICAL PROPERTIES

ODOR AND APPEARANCE:	Concrete like material
CHEMICAL FAMILY:	Refractory mortar
BOILING POINT:	Not applicable
WATER SOLUBILITY (%):	Not soluble in water
MELTING POINT:	Up to 3200°F (depending on the product)
SPECIFIC GRAVITY:	Not applicable
VAPOR PRESSURE:	Not applicable
pH:	Not applicable
VAPOR DENSITY:	Not applicable
VOLATILE BY VOLUME (%):	Not applicable
MOLECULAR FORMULA:	Not Applicable

10. STABILITY AND REACTIVITY

HAZARDOUS POLYMERIZATION:	Will not occur
CHEMICAL INCOMPATIBILITIES:	Powerful oxidizers; fluorine, manganese trioxide, oxygen disulfide
HAZARDOUS DECOMPOSITION PRODUCTS:	None

11. TOXICOLOGICAL INFORMATION

TOXICOLOGY

Dust samples from these products have not been tested. They may contain respirable crystalline silica.

Crystalline silica

Some samples of crystalline silica administered to rats by inhalation and intratracheal instillation have caused fibrosis and lung cancer. Mice and hamsters, similarly exposed, develop inflammatory disease including fibrosis but no lung cancer.

EPIDEMIOLOGY

No studies have been undertaken on humans exposed to these products in occupational environments.

Crystalline silica

Exposure to crystalline silica can cause silicosis, and exacerbate pulmonary tuberculosis and bronchitis. IARC (Monograph vol. 68, 1997) concluded that "crystalline silica from occupational sources inhaled in the form of quartz or cristobalite is carcinogenic to humans (Group 1)", and noted that "carcinogenicity in humans was not detected in all industrial circumstances studied" and "may be dependent on inherent characteristics of the crystalline silica or on external factors affecting its biological activity".

MSDS No: 141

Date Prepared: 05/01/1987

Current Date: 4/12/2006

Last Revised: (04/10/2006)

12. ECOLOGICAL INFORMATION

Adverse effects of this material on the environment are not anticipated.

13. DISPOSAL INFORMATION

WASTE MANAGEMENT

To prevent waste materials becoming airborne during waste storage, transportation and disposal, a covered container or plastic bagging is recommended. Comply with federal, state and local regulations.

DISPOSAL

If discarded in its purchased form, this product would not be a hazardous waste under Federal regulations (40 CFR 261) Any processing, use, alteration or chemical additions to the product, as purchased, may alter the disposal requirements. Under Federal regulations, it is the waste generator's responsibility to properly characterize a waste material, to determine if it is a hazardous waste. Check local, regional, state or provincial regulations to identify all applicable disposal requirements.

14. TRANSPORT INFORMATION

U.S. DEPARTMENT OF TRANSPORTATION (DOT)

Hazard Class:	Not Regulated	United Nations (UN) Number:	Not Applicable
Labels:	Not Applicable	North America (NA) Number:	Not Applicable
Placards:	Not Applicable	Bill of Lading:	Product Name

INTERNATIONAL

Canadian TDG Hazard Class & PIN: Not regulated
Not classified as dangerous goods under ADR (road), RID (train) or IMDG (ship).

15. REGULATORY INFORMATION

UNITED STATES REGULATIONS

SARA Title III: This product does not contain any substances reportable under Sections 302, 304, 313 (40 CFR 372). Sections 311 and 312 apply.

OSHA: Comply with Hazard Communication Standards 29 CFR 1910.1200 and 29 CFR 1926.59 and Respiratory Protection Standards 29 CFR 1910.134 and 29 CFR 1926.103.

TSCA: All substances contained in this product are listed in the TSCA Chemical Inventory

California: "Silica, crystalline (airborne particles of respirable size)" is listed in Proposition 65, The Safe Drinking Water and Toxic Enforcement Act of 1986 as a chemical known to the State of California to cause cancer.

Other States: Crystalline silica products are not known to be regulated by states other than California; however, state and local OSHA and EPA regulations may apply to these products. Contact your local agency if in doubt.

INTERNATIONAL REGULATIONS

Canadian WHMIS: Class D-2A Materials Causing Other Toxic Effects

Canadian EPA: All substances in this product are listed, as required, on the Domestic Substance List (DSL).

16. OTHER INFORMATION

SARA TITLE III HAZARD CATEGORIES

Acute Health:	No	Pressure Hazard:	No
Chronic Health:	Yes	Reactivity Hazard:	No
Fire Hazard:	No		

MSDS No: 141**Date Prepared: 05/01/1987****Current Date: 4/12/2006****Last Revised: (04/10/2006)****DEFINITIONS:**

ACGIH:	American Conference of Governmental Industrial Hygienists
ADR:	Carriage of Dangerous Goods by Road (International Regulation)
CAA:	Clean Air Act
CAS:	Chemical Abstracts Service Registry Number
CERCLA:	Comprehensive Environmental Response, Compensation and Liability Act
EPA:	Environmental Protection Agency
EU:	European Union
f/cc:	Fibers per cubic centimeter
HEPA:	High Efficiency Particulate Air
HMIS:	Hazardous Materials Identification System
IARC:	International Agency for Research on Cancer
IATA:	International Air Transport Association
IMDG:	International Maritime Dangerous Goods Code
mg/m³:	Milligrams per cubic meter of air
mppcf:	Million particles per cubic meter
MSHA:	Mine Safety and Health Administration
NFPA:	National Fire Protection Association
NIOSH:	National Institute for Occupational Safety and Health
OSHA:	Occupational Safety and Health Administration
PEL:	Permissible Exposure Limit
PNOC:	Particulates Not Otherwise Classified
PNOR:	Particulates Not Otherwise Regulated
RCRA:	Resource Conservation and Recovery Act
RID:	Carriage of Dangerous Goods by Rail (International Regulation)
SARA:	Superfund Amendments and Reauthorization Act
Title III:	Emergency Planning and Community Right to Know Act
...Section 302:	Extremely Hazardous Substances
...Section 304:	Emergency Release
...Section 311:	MSDS/List of Chemicals
...Section 312:	Emergency and Hazardous Inventory
...Section 313:	Toxic Chemicals Release Reporting
STEL:	Short-Term Exposure Limit
TCLP:	Toxicity Characteristics Leaching Procedures (EPA)
TLV:	Threshold Limit Values (ACGIH)
TSCA:	Toxic Substance Control Act
WHMIS:	Workplace Hazardous Materials Information System (Canada)
29 CFR 1910.134 & 1926.103:	OSHA Respiratory Protection Standards
29 CFR 1910.1200 & 1926.59:	OSHA Hazard Communication Standards

Revision Summary: **Section 1:** Product Cer-Flex® added.**MSDS Prepared By:** THERMAL CERAMICS ENVIRONMENTAL, HEALTH & SAFETY DEPARTMENT**DISCLAIMER**

The information presented herein is presented in good faith and believed to be accurate as of the effective date of this Material Safety Data Sheet. Employers may use this MSDS to supplement other information gathered by them in their efforts to assure the health and safety of their employees and the proper use of the product. This summary of the relevant data reflects professional judgment; employers should note that information perceived to be less relevant has not been included in this MSDS. Therefore, given the summary nature of this document, Thermal Ceramics does not extend any warranty (expressed or implied), assume any responsibility, or make any representation regarding the completeness of this information or its suitability for the purposes envisioned by the user.



MATERIAL SAFETY DATA SHEET

A.P. Green, Harbison-Walker and NARCO

Page 1/6

Printing date 05/12/2004

Reviewed on 06/12/2007

1 Identification of substance

· **Product details**

· **Trade name:** GREENSET-94-P

· **Manufacturer/Supplier:**

ANH Refractories Company
400 Fairway Drive
Moon Township, PA 15108

General Phone: (412)375-6600

· **Information department:** MSDS Technical Information: (412)375-6837

· **Emergency information:** CHEMTREC 24 HOUR EMERGENCY PHONE NUMBER: 1-800-424-9300.

2 Composition/Data on components

· **Chemical characterization**

· **Description:** Mixture of the substances listed below with nonhazardous additions.

· **Components:**

1344-28-1	non-fibrous alumina	60-100%
7664-38-2	phosphoric acid	5-10%
13530-50-2	aluminum phosphate binder (as P2O5)	1-2.5%
1302-78-9	Bentonite	1-2.5%
14808-60-7	crystalline silica (quartz)	0.1-0.5%

· **Additional information:** For the wording of the listed risk phrases refer to section 16.

3 Hazards identification

· **Hazard description:**

Toxic

· **Medical conditions aggravated by exposure to the product:** Asthma, chronic lung disease, and skin irritation.

· **Carcinogenicity Information:**

Crystalline silica is listed by IARC as a Group 1 Carcinogen "sufficient evidence of carcinogenicity in humans", and is listed by NTP as K, "Known To Be A Human Carcinogen".

· **Information pertaining to particular dangers for man and environment:**

The product has to be labelled due to the calculation procedure of the "General Classification guideline for preparations of the EU" in the latest valid version.

May cause cancer by inhalation.

Irritating to eyes, respiratory system and skin.

· **NFPA ratings (scale 0-4)**

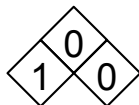

Health = 1

Fire = 0

Reactivity = 0

(Contd. on page 2)

USA



MATERIAL SAFETY DATA SHEET

A.P. Green, Harbison-Walker and NARCO

Page 2/6

Printing date 05/12/2004

Reviewed on 06/12/2007

Trade name: **GREENSET-94-P**

(Contd. from page 1)

· **HMIS Classification**

HEALTH	1	Health: 1
FIRE	0	Flammability: 0
REACTIVITY	0	Reactivity: 0

4 First aid measures

- **After inhalation:** Move to fresh air; consult doctor if needed.
- **After skin contact:** Immediately wash with water and soap and rinse thoroughly.
- **After eye contact:** Flush eyes with water for 15 minutes. If irritation persists, consult a doctor.
- **After swallowing:**
This product is intended for industrial applications; in the unlikely event that this product is swallowed, consult a physician if any adverse medical conditions occur.

5 Fire fighting measures

- **Suitable extinguishing agents:** Use fire fighting measures that suit the environment.
- **Protective equipment:** No special measures required.

6 Accidental release measures

- **Person-related safety precautions:** Not required.
- **Measures for environmental protection:** No special measures required.
- **Measures for cleaning/collecting:**
Dispose contaminated material as waste according to item 13.
Ensure adequate ventilation.

7 Handling and storage

- **Handling:**
- **Information for safe handling:**
Ensure good ventilation/exhaust at the workplace.
Prevent formation of dust.
- **Information about protection against explosions and fires:** No special measures required.
- **Storage:**
- **Requirements to be met by storerooms and containers:** No special requirements.
- **Information about storage in one common storage facility:** Not required.
- **Further information about storage conditions:** Store product inside, out of extreme weather conditions.

USA

(Contd. on page 3)



Trade name: GREENSET-94-P

(Contd. from page 2)

8 Exposure controls and personal protection

· **Components with limit values that require monitoring at the workplace:**

1344-28-1 non-fibrous alumina

PEL	15*;5** mg/m ³ *Total dust **Respirable fraction
TLV	10 mg/m ³ (e)

7664-38-2 phosphoric acid

PEL	1 mg/m ³
REL	Short-term value: 3 mg/m ³ Long-term value: 1 mg/m ³
TLV	Short-term value: 3 mg/m ³ Long-term value: 1 mg/m ³

14808-60-7 crystalline silica (quartz)

REL	0.05* mg/m ³ *Respirable dust
TLV	0.05 R mg/m ³

· **Personal protective equipment:**

· **General protective and hygienic measures:**

- Keep away from foodstuffs, beverages and feed.
- Wash hands before breaks and at the end of work.
- Store protective clothing separately.
- Avoid contact with the eyes and skin.

· **Breathing equipment:**



NIOSH approved respirators should be used if dust is present. A respiratory protection program should be implemented if exposures exceed OSHA PELs.

· **Protection of hands:**



Protective gloves recommended

The glove material has to be impermeable and resistant to the product/ the substance/ the preparation.

Due to missing tests no recommendation to the glove material can be given for the product/ the preparation/ the chemical mixture.

Selection of the glove material on consideration of the penetration times, rates of diffusion and the degradation

· **Material of gloves**

The selection of the suitable gloves does not only depend on the material, but also on further marks of quality and varies from manufacturer to manufacturer. As the product is a preparation of several substances, the resistance of the glove material can not be calculated in advance and has therefore to be checked prior to the application.

· **Penetration time of glove material**

The exact break through time has to be found out by the manufacturer of the protective gloves and has to be observed.

(Contd. on page 4)



MATERIAL SAFETY DATA SHEET

A.P. Green, Harbison-Walker and NARCO

Page 4/6

Printing date 05/12/2004

Reviewed on 06/12/2007

Trade name: GREENSET-94-P

(Contd. from page 3)

· **Eye protection:** Safety glasses with side shields recommended

9 Physical and chemical properties

· General Information

Form:	Solid
Color:	According to product specification
Odor:	No specific odor.

· Change in condition

Melting point/Melting range: Undetermined.
Boiling point/Boiling range: Undetermined.

· **Flash point:** Not applicable.

· **Auto igniting:** Product is not selfigniting.

· **Danger of explosion:** Product does not present an explosion hazard.

· **Density:** Not determined.

· **Solubility in / Miscibility with Water:** Insoluble.

10 Stability and reactivity

· **Thermal decomposition / conditions to be avoided:** No decomposition if used according to specifications.

· **Dangerous reactions** No dangerous reactions known.

· **Dangerous products of decomposition:**

Refractories containing crystalline silica may, after service, contain more or less crystalline silica. Care must be taken to avoid and/or control dust from demolition. If in doubt of the proper protection, seek advice from a safety professional.

11 Toxicological information

· **Acute toxicity:**

· **Primary acute effects:**

· **Skin contact:** Irritant to skin and mucous membranes.

· **Eye contact:** Irritating effect.

· **Sensitization:** No sensitizing effects known.

· **Additional toxicological information:**

The product shows the following dangers according to internally approved calculation methods for preparations:

Irritant

Carcinogenic if inhaled.

USA

(Contd. on page 5)



MATERIAL SAFETY DATA SHEET

A.P. Green, Harbison-Walker and NARCO

Page 5/6

Printing date 05/12/2004

Reviewed on 06/12/2007

Trade name: GREENSET-94-P

(Contd. from page 4)

12 Ecological information

· **General notes:** At present there are no ecotoxicological assessments.

13 Disposal considerations

- **Recommendation for Disposal of Product:**
As sold, this product is not RCRA hazardous. Final used condition must be evaluated prior to disposal. Dispose of waste product in accordance with Federal, State and Local regulations.
Dust created during demolition of used product may contain crystalline silica.
- **Recommendation for Disposal of Uncleaned Packaging:** Reuse, recycle or treat as industrial waste.

14 Transport information

· **Transport/Additional information:** Not dangerous according to available information.

15 Regulations

· SARA 313 TOXIC CHEMICALS

No material listed in the components in Section 2 of this MSDS is on the SARA 313 list.

· SARA 302 EXTREMELY HAZARDOUS SUBSTANCES

No material listed in the components in Section 2 of this MSDS is on the SARA 302 list.

· TSCA (Toxic Substances Control Act)

This substance or all the ingredients of this product are on the Chemical Substances Inventory of the Toxic Substances Control Act (TSCA Inventory). The presence on this list does not require any legal reporting.

· WHMIS Classification

Class D - Division 2 - Sub Division A
Untested mixture containing a very toxic material

Class D - Division 2 - Sub Division B
Untested mixture containing a toxic material

This product has been classified in accordance with the hazard criteria of the Controlled Products Regulations (CPR) and the MSDS contains all the information required by the CPR.

· Cancerogenity categories

· EPA (Environmental Protection Agency)

None of the ingredients is listed.

· IARC (International Agency for Research on Cancer)

14808-60-7	crystalline silica (quartz)	1
------------	-----------------------------	---

· NTP (National Toxicology Program)

14808-60-7	crystalline silica (quartz)	R
------------	-----------------------------	---

· TLV (Threshold Limit Value established by ACGIH)

1344-28-1	non-fibrous alumina	A4
14808-60-7	crystalline silica (quartz)	A2

(Contd. on page 6)



MATERIAL SAFETY DATA SHEET

A.P. Green, Harbison-Walker and NARCO

Page 6/6

Printing date 05/12/2004

Reviewed on 06/12/2007

Trade name: GREENSET-94-P

(Contd. from page 5)

· MAK (German Maximum Workplace Concentration)

1344-28-1	non-fibrous alumina	2
14808-60-7	crystalline silica (quartz)	1

· NIOSH-Ca (National Institute for Occupational Safety and Health)

14808-60-7	crystalline silica (quartz)	
------------	-----------------------------	--

· OSHA-Ca (Occupational Safety & Health Administration)

None of the ingredients is listed.

· Classification according to EU-guidelines

· Hazard symbols:

Toxic

· Hazard-determining components of labeling:

crystalline silica (quartz)

· Risk phrases:

May cause cancer by inhalation.

Irritating to eyes, respiratory system and skin.

· Safety phrases:

When using do not eat or drink.

Do not breathe dust.

Avoid contact with eyes.

In case of contact with eyes, rinse immediately with plenty of water and seek medical advice.

After contact with skin, wash immediately with plenty of soap and water

Wear suitable protective clothing and gloves.

In case of accident or if you feel unwell, seek medical advice immediately.

· National regulations:

· The following ingredients are known in the state of California to be a cancer risk (Proposition 65):

14808-60-7	crystalline silica (quartz)	
------------	-----------------------------	--

16 Other information

This information is based on our present knowledge. However, this shall not constitute a guarantee for any specific product features and shall not establish a legally valid contractual relationship.

· Contact: Patricia A. Kott 412-375-6712

· Creation date: 08/14/2000



100 Mansell Court East, Suite 300; Roswell, GA
30076
Telephone (770) 594-0660 Fax: (770)
645-3384
Customer Service: (800) 251-6327

MATERIAL SAFETY DATA SHEET

Section 1 - Material Identity

Product Trade Name(s): 6-Tile
Common Names(s): Kaolin Clay, China Clay
Chemical Name: Kaolin
CAS Number: 1332-58-7 (In TSCA Inventory)
Physical Form: White Powder

HMIS Ratings

Health Hazard	1
Flammability Hazard	0
Reactivity Hazard	0
Max. Personal Protection	E

Manufacturer's Name & Address: IMERYS Pigments & Additives Group, 100 Mansell Court East, Suite 300;
Roswell, GA 30076
Emergency Telephone: (800) 424-9300 CHEMTREC

Section 2 - Ingredients and Hazards

<u>Ingredient</u>	<u>Wt. % (Approx.)</u>	<u>CAS No.</u>	<u>OSHA PEL*</u>	<u>ACGIH TLV*</u>
Kaolin - Al ₂ Si ₂ O ₇ (OH) ₂	> 98%	1332-58-7	5 mg/m ³ Resp. 15 mg/m ³ Total	2 mg/m ³ Resp. --
Crystalline Silica, Quartz	> 0.1% - ~1%	14808-60-7	0.1 mg/m ³ Rcsp.	0.05 mg/m ³ Resp.
Water	< 2%			

* Unless otherwise noted, all PEL and TLV values are reported as 8 hour time weighted averages (TWA).

Section 3 - Hazards Identification and Cautions

Appearance: White Powder

Primary Routes of Entry: Skin contact, skin absorption, eye contact, ingestion: Hazard Classification - None.
(Historical basis for

classification.)

Target Organs: Eye, skin and lungs

Medical Conditions Aggravated by Exposure: Skin contact may aggravate existing dermatitis. Breathing excessive quantities of kaolin dust may aggravate pre-existing respiratory conditions.

Potential Health Effects:

Eye Contact: This product may produce irritation upon contact with the eye. See also Section 4 below.

Skin Contact: Prolonged or repeated exposure may cause skin irritation. Kaolin is not expected to be absorbed through the skin in harmful amounts or to produce an allergic skin reaction. See also Section 4 below.

Ingestion: No adverse effect is expected. If ingested, seek medical advice. See also Section 4 below.

Inhalation: Inhalation of excessive quantities of kaolin dust may irritate the respiratory tract. Prolonged exposure to respirable kaolin dust without use of appropriate respiratory equipment could adversely affect respiratory function including fibrogenic response. See Am. Rev. Respir. Dis. 1983; 127:215-220; 231-253; 141-142; Doc. Thres. Limit Values and Bio. Exp. Ind., Sixth Edition, 1991: OSHA PEL-29 C.F.R. 1910.1000.

Subchronic, Chronic: None expected. No applicable information was found concerning any potential health effects resulting from subchronic or chronic exposure to kaolin.

This product typically contains crystalline silica (quartz sand) above 0.1% as a naturally occurring impurity. The International Agency for Research on Cancer has concluded that "crystalline silica inhaled in the form of quartz or

crystalhalite from occupational sources is carcinogenic to humans (Group I)." It also noted that carcinogenicity was not detected in all industrial circumstance studies, and may be dependent on external factors affecting its biological activity or distribution of its polymorphs. (See IARC Monographs on the Evaluation of Carcinogenic Risks to Humans, Volume 68 (1997).) Exposure to respirable silica has also been associated with silicosis, scleroderma, and nephrotoxicity. (See Occupational Lung Disorders, Third Edition, Chapter 12 (1994) and American Journal of Respiratory and Critical Care Medicine, Volume 155, pp 761-765 (1997).)

Section 4 - First Aid Measures

Eye Contact: Follow good industrial hygiene practices. In case of contact, immediately flush eyes with plenty of water. Seek medical aid if necessary.

Skin Contact: Follow good industrial hygiene practices. Wash affected skin areas thoroughly with soap and water. Seek medical aid if necessary.

Inhalation: Follow good industrial hygiene practices. If excessive exposure by inhalation is suspected, remove to fresh air. If necessary, a MSHA/NIOSH or OSHA/NIOSH approved respirator is recommended. Seek medical aid if necessary.

Ingestion: Follow good industrial hygiene practices. If ingested, do not induce vomiting. If conscious, drink two glasses of water. Seek medical aid if necessary.

Section 5 - Fire Fighting Measures

Explosion Data: Not Explosive
LEL: Not Applicable
UEL: Not Applicable
Extinguishing Media: Product will not burn.
NFPA 704M Hazard Classification: Health: 1 Flammable: 0 Reactivity: 0

Flammability: Not Flammable or Combustible
Flash Point: Not Applicable
Auto-Ignition: Not Applicable

Use appropriate extinguishing media for packaging material if applicable.

Section 6 - Accidental Release Measures

Vacuum, pump or scoop spilled material into containers for reclaiming or disposal. Use proper respiratory and personal protective equipment. MSHA/NIOSH or OSHA/NIOSH approved respirator recommended. Spilled materials may cause slippery conditions when wet. Care should be exercised when walking on spills on floors or concrete pads. No neutralizing chemicals required. Material is inert and nonreactive. Kaolin is not a CERCLA listed hazardous substance.

Section 7 - Handling and Storage

Storage in a cool, dry location is recommended.
 Spilled materials may cause slippery conditions when wet. Care should be exercised when walking on spills on floors or concrete pads.
 Minimize dust generation & accumulation.
 If excessive dust is generated, provide adequate ventilation and use proper respiratory and personal protective equipment.
 MSHA/NIOSH or OSHA/NIOSH approved respirator recommended

Section 8 - Exposure Control/Personal Protection

<u>Hazardous Ingredient</u>	<u>Weight % (Approx.)</u>	<u>CAS No.</u>	<u>MSHA PEL</u>	<u>OSHA PEL</u>	<u>ACGIH TLV</u>
		1332-58-7	10mg/cu.m. Total	15mg/cu.m. Total 5 mg/cu.m. Resp.	2 mg/cu.m. Respirable
Crystalline Silica, Quartz	> 0.1% - ~1%	14808-60-7	0.1 mg/m ³ Resp	0.1 mg/m ³ Resp.	0.05 mg/m ³ Resp.

Unless otherwise noted, all PEL and TLV values are reported as 8 hour time weighted averages (TWA).

Respiratory Protection: If respirator is required, use of a MSHA/NIOSH or OSHA/NIOSH approved respirator is recommended.

Ventilation: Use exhaust ventilation, if required, to maintain dust concentration below recommended exposure limits.

Protective Equipment: Wear side shield safety glasses. Rubber gloves are recommended for prolonged exposure.

Section 9 - Physical and Chemical Properties

Physical State:	Solid	Boiling Point:	Not Applicable
Appearance & Odor:	Odorless, white powder	Freezing Point:	Not Applicable
pH (Aqueous Suspension):	4.0 - 6.0	Vapor Pressure:	Not Applicable
Specific Gravity:	~2.6	Vapor Density:	Not Applicable
% Solubility in Water:	Insoluble	VOC:	None

Melting Point: Not Determined, > 1500°C Evaporation Rate: Not Applicable

Section 10 - Stability and Reactivity

Chemically Stable? Yes X No ___ Inert and nonreactive.
Compatible with Other Substances? Yes X No ___ Inert and nonreactive.
Hazardous Decomposition/By-Products: No hazardous decomposition or by-products expected. Inert and nonreactive.
Conditions Contributing to Hazardous Polymerization: None, inert and nonreactive.

Section 11 - Disposal Considerations

EPA Waste Number: Under RCRA (40 CFR 261) kaolin is a non-hazardous waste. Dispose of waste material in accordance with all local, state and federal requirements.

Section 12 - Toxicological Information

kaolin - CAS No. 1332-58-7
Primary Route of Exposure: X Skin; X Eye Contact; X Inhalation; ___ Ingestion

Acute Health Hazards:
Eye contact may cause mechanical irritation if exposed to excessive amounts of kaolin.
Skin contact may aggravate existing dermatitis.
Inhalation from prolonged and continuous exposure to excessive quantities of dust may aggravate existing asthmatic or respiratory conditions.
No adverse effect expected when ingested.

Chronic Health Hazards:
Prolonged inhalation of excessive levels of kaolin dust may cause a simple pneumoconiotic condition, not normally associated with a decrement in lung function. In cases of long term exposure to extremely high levels of dust, complicated pneumoconiosis with lung function impairment may occur.

Carcinogenicity*: NTP? No IARC? No OSHA? No
Mutagenicity: None known Teratogenicity: None known Reproductive Effects: None known

* See Section 3 for discussion of crystalline silica.

Section 13 - Transport Information

EPA Waste Number: Not Regulated
DOT Classification: Not Regulated DOT/IMO Classification: Not Regulated
Internal UN: Not Regulated

Section 14 - Regulatory Information

FDA: Kaolin is as generally recognized as safe (GRAS) under the FDA in accordance with 21 CFR 186.1256. Additionally, kaolin is established as a component of the uncoated or coated food-contact surface of paper and paperboard in accordance with 21 CFR 176.170 (aqueous and fatty foods) and 21 CFR 176.180 (dry foods).

SARA Title III Section 302 Extremely Hazardous Substances: This product does not contain extremely hazardous substances subject to the reporting requirements of Section 302 of Title III of the Superfund Amendments and Reauthorization Act of 1986 and 40 CFR Part 355.

SARA Title III Section 311 and 312 Health and Physical Hazard Categories per 40 CFR 370.2:

Immediate	Delayed	Fire	Pressure	Reactivity
Yes	Yes	No	No	No

SARA Section 313 Notification: This product does not contain toxic chemicals subject to the reporting requirements of Section 313 of Title III of the Superfund Amendments and Reauthorization Act of 1986 and 40 CFR Part 372.

TSCA: Product is listed in Initial Inventory, Vol. 1, Appendix A, CAS No. 1332-58-7.

The International Agency for Research on Cancer has concluded that "crystalline silica inhaled in the form of quartz or cristobalite from occupational sources is carcinogenic to humans (Group I)." It also noted that carcinogenicity was not detected in all industrial circumstance studies, and may be dependent on external factors affecting its biological activity or distribution of its polymorphs. (See IARC Monographs on the Evaluation of Carcinogenic Risks to Humans, Volume 68 (1997).) Exposure to respirable silica has also been associated with silicosis, scleroderma, and nephrotoxicity. (See Occupational Lung Disorders, Third Edition, Chapter 12 (1994) and American Journal of Respiratory and Critical Care Medicine, Volume 155, pp 761-765 (1997).)

WARNING: This product may also contain extremely small amounts of one or more naturally-occurring materials known to the State of California to cause cancer, birth defects, or other reproductive harm.

While this information and recommendations set forth herein are believed to be accurate as of the date hereof, IMERYS PIGMENTS & ADDITIVES GROUP MAKES NO WARRANTY, EXPRESS OR IMPLIED, WITH RESPECT HERETO

AND DISCLAIMS ALL LIABILITY FROM RELIANCE THEREON.

IMERYS is a business name of IMERYS Pigments, Inc., IMERYS Kaolin, Inc. and IMERYS Marble, Inc.
Registered in the USA. Registered Office: 100 Mansell Court East, Suite 300, Roswell, GA 30076.

Date Prepared: 07/27/82

Revised: 06/2000

MSDS Number: **A2796** * * * * * Effective Date: **11/09/06** * * * * * Supersedes: **02/12/04**

This material is
used in the Cone 10
Kiln Wash



From: Mallinckrodt Baker, Inc.
222 Red School Lane
Phillipsburg, NJ 08865



24 Hour Emergency Telephone: 908-859-2151
CHEMTREC: 1-800-424-9300

National Response in Canada
CANUTEC: 613-996-6666

Outside U.S. And Canada
Chemtrec: 703-527-3887

NOTE: CHEMTREC, CANUTEC and National Response Center emergency numbers to be used only in the event of chemical emergencies involving a spill, leak, fire, exposure or accident involving chemicals.

All non-emergency questions should be directed to Customer Service (1-800-582-2537) for assistance.

Aluminum Hydroxide

1. Product Identification

Synonyms: Aluminum hydrate; Aluminum trihydrate; Hydrated alumina

CAS No.: 21645-51-2

Molecular Weight: 78.00

Chemical Formula: Al(OH)₃

Product Codes: 0518

2. Composition/Information on Ingredients

Ingredient	CAS No	Percent	Hazardous
Aluminum Hydroxide	21645-51-2	98 - 100%	Yes

3. Hazards Identification

Emergency Overview

WARNING! CAUSES IRRITATION TO EYES AND RESPIRATORY TRACT.

SAF-T-DATA^(tm) Ratings (Provided here for your convenience)

Health Rating: 1 - Slight

Flammability Rating: 0 - None

Reactivity Rating: 1 - Slight

Contact Rating: 2 - Moderate

Lab Protective Equip: GOGGLES; LAB COAT; PROPER GLOVES

Storage Color Code: Green (General Storage)

Potential Health Effects

Inhalation:

Causes irritation to the respiratory tract. Symptoms may include coughing, shortness of breath.

Ingestion:

Not expected to be a health hazard via ingestion.

Skin Contact:

Not expected to be a health hazard from skin exposure.

Eye Contact:

Causes irritation, redness, and pain.

Chronic Exposure:

Repeated exposure may cause symptoms similar to those listed for acute effects. Prolonged contact with skin may result in minor mechanical irritation.

Aggravation of Pre-existing Conditions:

No information found.

4. First Aid Measures

Inhalation:

Remove to fresh air. If not breathing, give artificial respiration. If breathing is difficult, give oxygen. Get medical attention.

Ingestion:

Not expected to require first aid measures. If large amounts were swallowed, give water to drink and get medical advice.

Skin Contact:

Wash exposed area with soap and water. Get medical advice if irritation develops.

Eye Contact:

Immediately flush eyes with plenty of water for at least 15 minutes, lifting lower and upper eyelids occasionally. Get medical attention immediately.

5. Fire Fighting Measures

Fire:

Not considered to be a fire hazard.

Explosion:

Not considered to be an explosion hazard.

Fire Extinguishing Media:

Use any means suitable for extinguishing surrounding fire.

Special Information:

In the event of a fire, wear full protective clothing and NIOSH-approved self-contained breathing apparatus with full facepiece operated in the pressure demand or other positive pressure mode.

6. Accidental Release Measures

Ventilate area of leak or spill. Wear appropriate personal protective equipment as specified in Section 8. Spills: Sweep up and containerize for reclamation or disposal. Vacuuming or wet sweeping may be used to avoid dust dispersal.

7. Handling and Storage

Keep in a tightly closed container, stored in a cool, dry, ventilated area. Protect against physical damage. Isolate from incompatible substances. Containers of this material may be hazardous when empty since they retain product residues (dust, solids); observe all warnings and precautions listed for the product.

8. Exposure Controls/Personal Protection

Airborne Exposure Limits:

None established.

Ventilation System:

In general, dilution ventilation is a satisfactory health hazard control for this substance. However, if conditions of use create discomfort to the worker, a local exhaust system should be considered.

Personal Respirators (NIOSH Approved):

For conditions of use where exposure to dust or mist is apparent and engineering controls are not feasible, a particulate respirator (NIOSH type N95 or better filters) may be worn. If oil particles (e.g. lubricants, cutting fluids, glycerine, etc.) are present, use a NIOSH type R or P filter. For emergencies or instances where the exposure levels are not known, use a full-face positive-pressure, air-supplied respirator. WARNING: Air-purifying respirators do not protect workers in oxygen-deficient atmospheres.

Skin Protection:

Wear protective gloves and clean body-covering clothing.

Eye Protection:

Use chemical safety goggles and/or full face shield where dusting or splashing of solutions is possible. Maintain eye wash fountain and quick-drench facilities in work area.

9. Physical and Chemical Properties

Appearance:

White Powder.

Odor:

Odorless.

Solubility:

Practically insoluble in water.

Specific Gravity:

2.42

pH:

> 7 (Basic).

% Volatiles by volume @ 21C (70F):

0

Boiling Point:

No information found.

Melting Point:

300C (572F)

Vapor Density (Air=1):

Not applicable.

Vapor Pressure (mm Hg):

Not applicable.

Evaporation Rate (BuAc=1):

No information found.

10. Stability and Reactivity

Stability:

Stable under ordinary conditions of use and storage. Aluminum hydroxide forms a gel on prolonged contact with water; absorbs acids and carbon dioxide.

Hazardous Decomposition Products:

May produce oxides of aluminum.

Hazardous Polymerization:

Will not occur.

Incompatibilities:

Strong acids, strong oxidizers. Aluminum hydroxide can react dangerously with bismuth.

Conditions to Avoid:

Moisture and incompatibles.

11. Toxicological Information

No LD50/LC50 information found relating to normal routes of occupational exposure.

Ingredient	---NTP Carcinogen---		IARC Category
	Known	Anticipated	
Aluminum Hydroxide (21645-51-2)	No	No	None

12. Ecological Information

Environmental Fate:

No information found.

Environmental Toxicity:

No information found.

13. Disposal Considerations

Whatever cannot be saved for recovery or recycling should be managed in an appropriate and approved waste disposal facility. Processing, use or contamination of this product may change the waste management options. State and local disposal regulations may differ from federal disposal regulations. Dispose of container and unused contents in accordance with federal, state and local requirements.

14. Transport Information

Not regulated.

15. Regulatory Information

-----\Chemical Inventory Status - Part 1\-----				
Ingredient	TSCA	EC	Japan	Australia
Aluminum Hydroxide (21645-51-2)	Yes	Yes	Yes	Yes

-----\Chemical Inventory Status - Part 2\-----				
Ingredient	Korea	--Canada--		
		DSL	NDSL	Phil.
Aluminum Hydroxide (21645-51-2)	Yes	Yes	No	Yes

-----\Federal, State & International Regulations - Part 1\-----				
Ingredient	-SARA 302-		-----SARA 313-----	
	RQ	TPQ	List	Chemical Catg.
Aluminum Hydroxide (21645-51-2)	No	No	No	No

-----\Federal, State & International Regulations - Part 2\-----				
---	--	--	--	--

Ingredient	CERCLA	-RCRA- 261.33	-TSCA- 8(d)
Aluminum Hydroxide (21645-51-2)	No	No	No

Chemical Weapons Convention: No TSCA 12(b): No CDTA: No
 SARA 311/312: Acute: Yes Chronic: Yes Fire: No Pressure: No
 Reactivity: No (Pure / Solid)

Australian Hazchem Code: None allocated.

Poison Schedule: None allocated.

WHMIS:

This MSDS has been prepared according to the hazard criteria of the Controlled Products Regulations (CPR) and the MSDS contains all of the information required by the CPR.

16. Other Information

NFPA Ratings: Health: 1 Flammability: 0 Reactivity: 0

Label Hazard Warning:

WARNING! CAUSES IRRITATION TO EYES AND RESPIRATORY TRACT.

Label Precautions:

Avoid contact with eyes, skin and clothing.

Wash thoroughly after handling.

Avoid breathing dust.

Keep container closed.

Use only with adequate ventilation.

Label First Aid:

In case of eye contact, immediately flush eyes with plenty of water for at least 15 minutes. Remove material from skin and clothing. If inhaled, remove to fresh air. If not breathing, give artificial respiration. If breathing is difficult, give oxygen. In all cases, get medical attention.

Product Use:

Laboratory Reagent.

Revision Information:

MSDS Section(s) changed since last revision of document include: 3.

Disclaimer:

Mallinckrodt Baker, Inc. provides the information contained herein in good faith but makes no representation as to its comprehensiveness or accuracy.

This document is intended only as a guide to the appropriate precautionary handling of the material by a properly trained person using this product.

Individuals receiving the information must exercise their independent judgment in determining its appropriateness for a particular purpose.

MALLINCKRODT BAKER, INC. MAKES NO REPRESENTATIONS OR WARRANTIES, EITHER EXPRESS OR IMPLIED, INCLUDING WITHOUT LIMITATION ANY WARRANTIES OF MERCHANTABILITY, FITNESS FOR A PARTICULAR PURPOSE WITH RESPECT TO THE INFORMATION SET FORTH HEREIN OR THE PRODUCT TO WHICH THE INFORMATION REFERS. ACCORDINGLY, MALLINCKRODT BAKER, INC. WILL NOT BE RESPONSIBLE FOR DAMAGES RESULTING FROM USE OF OR RELIANCE UPON THIS INFORMATION.

Prepared by: Environmental Health & Safety

Phone Number: (314) 654-1600 (U.S.A.)

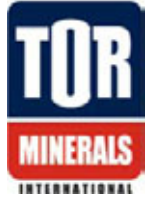

HMIS RATING
 HEALTH ----- 1
 FLAMMABILITY ----- 0
 REACTIVITY ----- 0
 PERSONAL PROTECTION - E

Material Safety Data Sheet

May be used to comply with
 OSHA's Hazard Communication Standard,
 29 CFR 1910.1200. Standard must be
 consulted for specific requirements.

U.S. Department of Labor

Occupational Safety and Health Administration
 (Non-Mandatory Form)
 Form Approved
 OMB No. 1218-0072



IDENTITY (As Used on Label and List)

HALTEX® Alumina Trihydrate (all grades)

Note: Blank spaces are not permitted. If any item is not applicable, or no information is available, the space must be marked to indicate that.

Section I

Manufacturer's Name TOR Minerals International	Emergency Telephone Number 361/883-5591
Address (Number, Street, City, State, and ZIP Code) 722 Burleson Street (Plant) Corpus Christi, TX 78402	Telephone Number for Information 361/883-5591
	Date Prepared January 2006
	Signature of Preparer (optional)

Section II - Hazardous Ingredients/Identity Information

Hazardous Components (Specific Chemical Identity; Common Name(s))	OSHA PEL	ACGIH TLV	Other Limits Recommended	% (optional)
Aluminium Trihydrate (Al(OH)₃) (CAS No. 21645-51-2)	10 mg/m³ (dust)	10 mg/m³ (dust)		100.0%
<i>(These are typical quantities and may change slightly with different lots.)</i>				

Section III - Physical/Chemical Characteristics

Boiling Point	2980 ± 60	Specific Gravity (H ₂ O = 1)	2.38 - 2.42
Vapor Pressure (mm Hg.)	N/A	Melting Point	2015 ± 15
Vapor Density (AIR = 1)	N/A	Evaporation Rate (Butyl Acetate = 1)	N/A
Solubility in Water	Insoluble		
Appearance and Odor	Fine white powder with no odor.		

Section IV - Fire and Explosion Hazard Data

Flash Point (Method Used)	Non-flammable	Flammable Limits	N/A	LEL	N/A	UEL	N/A
Extinguishing Media	As appropriate for surrounding combustibles. Does not burn or support combustion.						
Special Fire Fighting Procedures	Fire fighters should wear self-contained breathing apparatus.						
Unusual Fire and Explosion Hazards	No fire or explosion hazard.						

Section V - Reactivity Data

Stability	Unstable		Conditions to Avoid	None in normal or expected use
	Stable	X		
Incompatibility (Material to Avoid) None Known				
Hazardous Decomposition or Byproducts None in normal or expected use				
Hazardous Polymerization	May Occur		Conditions to Avoid	None in normal or expected use
	Will Not Occur	X		

Section VI - Health Hazard Data

Route(s) of Entry:	Primary	Inhalation?	Yes	Skin? Eye ?	No Yes	Ingestion?	Yes
Health Hazards (Acute and Chronic) Hydrated Alumina is environmentally safe and is not regulated under RCRA. None of the components are on the EPA list of Extremely Hazardous Substances. However, high exposure to Alumina dust may produce irritation to the eyes and respiratory system.							
Carcinogenicity:	None known.	NTP?	N/A	IARC Monographs?	N/A	OSHA Regulated?	N/A

Signs and Symptoms of Irritation
Irritation of dust may cause mechanical irritation of the respiratory tract. Skin and eye contact may cause mechanical abrasion - irritation.

Medical Conditions
Generally Aggravated by Exposure Pre-existing upper respiratory and lung diseases such as, but not limited to, bronchitis, emphysema, and asthma.

Emergency and First Aid Procedures
Eye contact: Flush eye with generous amounts of water for 15 min., consult a physician.
Inhalation: Remove to fresh air. **Skin contact:** Wash from skin with soap and water. **Ingestion:** Consult a physician.

Section VII - Precautions for Safe Handling and Use

Steps to Be Taken in Case Material is Released or Spilled
Handle and keep in dry building area. Avoid handling methods which cause dusting. Avoid breathing dust. Use ventilation that will maintain exposure below recommended TLV. Wear goggles and use NIOSH/MSHA approved respirator. Wash thoroughly after handling.

Waste Disposal Method
Disposal must be made in accordance with Federal, State, and Local regulations, and pursuant to 40 CFR p. 261 of RCRA regulations currently in effect. Discarded hydrated alumina would not be classified as hazardous waste.

Precautions to Be Taken in Handling and Storing
Handle and keep in dry building area. Avoid handling methods which cause dusting. Avoid breathing dust. Use ventilation that will maintain exposure below recommended TLV. Wear goggles and use NIOSH/MSHA approved respirator. Wash thoroughly after handling.

Other Precautions No special requirements. Use good, acceptable industrial hygiene practices.

Section VIII - Control Measures

Respiratory Protection (Specify Type) Use NIOSH approved respirator in accordance with air contaminant standard.	
Ventilation	Local Exhaust Provide local system. Special Mechanical (General) Is recommended for potentially dusty conditions. Other
Protective Gloves No special requirement, ordinary work type.	Eye Protection Safety glasses or vented goggles.
Other Protective Clothing or Equipment No special requirement, ordinary work clothes.	
Work/Hygienic Practices Good industrial hygiene practices. Wash thoroughly with soap and water before eating, drinking, or using tobacco products.	

The information herein is believed to be correct and reliable. However no warranty is expressed or implied regarding the accuracy of these data, and none is made as to the marketability of the material or its fitness for any purpose. The consumer accepts the responsibility of and the conditions for liability of use of the products.

MATERIAL SAFETY DATA SHEET

MSDS No: 093

UNIMIN CORPORATION
258 Elm Street
New Canaan, CT 06840

Emergency Telephone Number
(203) 966-8880

Telephone Number for Information
(203) 966-8880

Date Prepared: July 2000

SECTION 1: IDENTIFICATION

PRODUCT NAME: Kaolin Slurry

SYNONYMS: Kaolin, China Clay, Hydrated Aluminum Silicate

SECTION 2: COMPONENTS

CAS#	Component	Percentage	Exposure Limits
1332-58-7	Kaolin	>65%	PEL – 5 mg/m ³ TWA (respirable fraction) TLV- 2 mg/m ³ TWA (respirable fraction) MSHA - 5 mg/m ³ TWA (respirable fraction)
14808-60-7	Crystalline Silica in the form of Quartz	<1%	PEL - See Below TLV- 0.05 mg/m ³ TWA (respirable fraction) MSHA - See Below
13463-67-7	Titanium Dioxide	<2%	PEL – 15 mg/m ³ TWA (total dust) TLV- 10 mg/m ³ TWA MSHA - 15 mg/m ³ TWA (total dust)
7332-18-5	Water	<34%	None Established

OSHA PEL and MSHA Exposure Limit for Crystalline Silica, Quartz: $\frac{10 \text{ mg/m}^3}{\% \text{ Silica} + 2}$
(Respirable)

National Institute for Occupational Safety and Health (NIOSH) has recommended that the permissible exposure limit be changed to 50 micrograms respirable free silica per cubic meter of air (0.05 mg/m³) as determined by a full shift sample up to 10 hour working day, 40 hours per week. The 1974 NIOSH Criteria for a recommended Standard for Occupational Exposure to Crystalline Silica should be consulted for more detailed information.

PEL means OSHA Permissible Exposure Limit.

TLV means American Conference of Governmental Industrial Hygienists (ACGIH) Threshold Limit Value.

MSHA means Mine Safety and Health Administration Exposure Limit.

TWA means 8 hour time weighted average.

Note: The Permissible Exposure Limits (PEL) reported above are the pre-1989 limits that were reinstated by OSHA June 30, 1993 following a decision by the 11th Circuit Court of Appeals. These PELs are now being enforced by Federal OSHA. Be aware that more restrictive exposure limits may be enforced by some states, agencies or other authorities.

SECTION 3: HAZARDS IDENTIFICATION

EMERGENCY OVERVIEW

This product is an aqueous slurry of a chemically inert, non-combustible mineral. A single exposure will not result in serious adverse effects. When this product is in a dryer form, prolonged and excessive inhalation of dust may cause lung disease, pneumoconiosis, with symptoms of shortness of breath and reduced pulmonary function. See "Cancer Status" in this Section

HEALTH HAZARDS:

Inhalation: Breathing prolonged and excessive amounts of kaolin dust may not cause noticeable injury or illness even though permanent lung damage may be occurring. Inhalation of dust may have the following serious chronic health effects:

Pneumoconiosis: Excessive inhalation of respirable dust may cause pneumoconiosis, a respiratory disease, which can result in delayed, progressive, disabling and sometimes fatal lung injury. Symptoms include cough, shortness of breath, wheezing, non-specific chest illness and reduced pulmonary function. This disease is exacerbated by smoking. Individuals with pneumoconiosis are predisposed to develop tuberculosis.

Cancer Status: The International Agency for Research on Cancer has determined that crystalline silica inhaled in the form of quartz or cristobalite from occupational sources is carcinogenic to humans (Group 1 - carcinogenic to humans). Refer to IARC Monograph 68, Silica, Some Silicates and Organic Fibres (published in June 1997) in conjunction with the use of these materials. The National Toxicology Program classifies respirable crystalline silica as "known to be a human carcinogen". Refer to the 9th Report on Carcinogens (2000). The American Conference of Governmental Industrial Hygienists (ACGIH) classifies crystalline silica, quartz, as a suspected human carcinogen (A2).

Other Data with Possible Relevance to Human Health:

There is some evidence that breathing respirable crystalline silica or the disease silicosis is associated with an increased incidence of significant disease endpoints such as scleroderma (an immune system disorder manifested by fibrosis of the lungs, skin and other internal organs) and kidney disease.

For further information consult "Adverse Effects of Crystalline Silica Exposure" published by the American Thoracic Society Medical Section of the American Lung Association, American Journal of Respiratory and Critical Care Medicine, Volume 155, pages 761-768, 1997.

Inhalation of dust may cause irritation of the nose, throat and respiratory passages.

Skin Contact: No adverse effects expected.

Eye Contact: Contact may cause mechanical irritation and possible injury.

Ingestion: No adverse effects expected for normal, incidental ingestion.

Chronic Health Effects: See "Inhalation" subsection above with respect to silicosis, cancer status and other data with possible relevance to human health.

Medical Conditions Aggravated by Exposure: Individuals with respiratory disease, including but not limited to, asthma and bronchitis, or subject to eye irritation should not be exposed to respirable quartz dust.

Signs and Symptoms of Exposure: There are generally no signs or symptoms of exposure to crystalline silica (quartz). See "Inhalation" subsection above for symptoms of silicosis.

SECTION 4: FIRST AID

Gross Inhalation: Remove victim to fresh air. If breathing has stopped, perform artificial respiration. If breathing is difficult have qualified personnel administer oxygen. Get prompt medical attention.

Skin Contact: No first aid should be needed since this product does not affect the skin. Wash exposed skin with soap and water before breaks and at the end of the shift.

Eye Contact: Flush the eyes immediately with large amounts of running water, lifting the upper and lower lids occasionally. If irritation persists or for imbedded foreign body, get immediate medical attention.

Ingestion: If large amounts are swallowed, get immediate medical attention.

SECTION 5: FIRE AND EXPLOSION DATA

Flash Point (Method Used): Fully oxidized, will not burn.

Autoignition Temp: Will not burn.

Flammable Limits: LEL: Not applicable UEL: Not applicable

Extinguishing Media: This product will not burn but is compatible with all extinguishing media. Use any media that is appropriate for the surrounding fire.

Special Fire Fighting Procedures: None required with respect to this product. Firefighters should always wear self-contained breathing apparatus for fires indoors or in confined areas.

Unusual Fire and Explosion Hazards: None.

Hazardous Combustion Products: None.

SECTION 6: ACCIDENTAL RELEASE MEASURES

Wear appropriate protective equipment. If uncontaminated, collect using dustless method (HEPA vacuum or wet method) and place in appropriate container for use. If contaminated: a) use appropriate method for the nature of contamination, b) consider possible toxic or fire hazards associated with the contaminating substances. Collect for disposal.

SECTION 7: HANDLING AND STORAGE

Do not breathe dust. Do not rely on your sight to determine if dust is in the air. Silica may be in the air without a visible dust cloud. Use normal precautions against bag breakage or spills of bulk material. Avoid creation of respirable dust. Use good housekeeping in storage and use areas to prevent accumulation of dust in work area.

Use adequate ventilation and dust collection. Maintain and use proper, clean respiratory equipment (See Section 8). Launder clothing that has become dusty. Empty containers (bags, bulk containers, storage tanks, etc.) retain silica residue and must be handled in accordance with the provisions of this Material Safety Data Sheet. WARN and TRAIN employees in accordance with state and federal regulations.

WARN YOUR EMPLOYEES (AND YOUR CUSTOMERS - USERS IN CASE OF RESALE) BY POSTING AND OTHER MEANS OF THE HAZARDS AND OSHA PRECAUTIONS TO BE USED. PROVIDE TRAINING FOR YOUR EMPLOYEES ABOUT OSHA PRECAUTIONS.

Additional information on silica hazards and precautionary measures can be found at the following websites:

NIOSH Joint Campaign on Silicosis Prevention <http://www.cdc.gov/niosh/sicampn.html>

OSHA Crystalline Silica Website <http://www.osha-slc.gov/SLTC/silicacrystalline/index.html>

MSHA Silicosis Prevention Website <http://www.msha.gov/S&HINFO/SILICO/SILICO.HTM>

SECTION 8: EXPOSURE CONTROLS/PERSONAL PROTECTION

Ventilation: Use local exhaust as required to maintain exposures below applicable occupational exposure limits (See Section 2). See also ACGIH "Industrial Ventilation - A Manual for Recommended Practice", (current edition).

Respiratory Protection: Use appropriate respiratory protection for respirable particulates based on consideration of airborne workplace concentrations and duration of exposure arising from intended end use. Refer to the most recent standards of ANSI (Z88.2), OSHA (29 CFR 1910.134), MSHA (30 CFR Parts 56 and 57) and NIOSH Respirator Decision Logic.

Gloves: Protective gloves recommended.

Eye Protection: Safety glasses or goggles recommended.

Other Protective Equipment/Clothing: As appropriate for the work environment. Dusty clothing should be laundered before reuse.

9: PHYSICAL AND CHEMICAL PROPERTIES

Appearance and Odor: White to cream colored slurry with a slight earthy odor.

pH: Not determined

Boiling Point: Not applicable

Melting Point: Not applicable

Solubility in Water: Negligible

Percent Volatile: Not determined

Specific Gravity (water=1): 1.78-2.58

Vapor Pressure: Not applicable

Vapor Density: Not applicable

Evaporation Rate: Not applicable

Fusion Range: 1569-1785°C

SECTION 10: STABILITY AND REACTIVITY

Stability: Stable

Conditions to Avoid: When exposed to high temperatures, free quartz can change crystal structures to form tridymite (above 870°C) or cristobalite (above 1470°C) which have greater health hazards than quartz.

Incompatibility: Powerful oxidizing agents such as fluorine, chlorine trifluoride, manganese trioxide, etc.

Hazardous Decomposition Products: Silica will dissolve in hydrofluoric acid producing a corrosive gas, silicon tetrafluoride.

Hazardous Polymerization: Will not occur.

Conditions to Avoid: None

SECTION 11: TOXICOLOGICAL INFORMATION

No acute toxicity data is available for product or components. Refer to Section 3 for health hazard information.

SECTION 12: ECOLOGICAL INFORMATION

No ecotoxicity data is available. This product is not expected to present an environmental hazard.

SECTION 13: DISPOSAL

Waste Disposal Method: If uncontaminated, dispose as an inert, non-metallic mineral. If contaminated, dispose in accordance with all applicable local, state/provincial and federal regulations.

SECTION 14: TRANSPORTATION DATA

U.S. DOT HAZARD CLASSIFICATION

Proper Shipping Name: Not Regulated
Technical Name: N/A
UN Number: N/A
Hazard Class/Packing Group: N/A
Labels Required: None
DOT Packaging Requirements: N/A
Exceptions: N/A

SECTION 15: OTHER REGULATORY INFORMATION

SARA 311/312: Hazard Categories for SARA Section 311/312 Reporting: Chronic Health

SARA 313 This Product Contains the Following Chemicals Subject to Annual Release Reporting Requirements Under the SARA Section 313 (40 CFR 372): None

CERCLA Section 103 Reportable Quantity: None

California Proposition 65: This product contains crystalline silica (respirable) which is known to the State of California to cause cancer.

Toxic Substances Control Act: All of the components of this product are listed on the EPA TSCA Inventory or exempt from notification requirements.

European Inventory of Commercial Chemical Substances: All of the components of this product are listed on the EINECS Inventory or exempt from notification requirements. (The EINECS number for Quartz: 231-545-4)

Canadian Environmental Protection Act: All the components of this product are listed on the Canadian Domestic Substances List or exempt from notification requirements.

Japan MITI: All of the components of this product are existing chemical substances as defined in the Chemical Substance Control Law.

Australian Inventory of Chemical Substances: All of the components of this product are listed on the AICS inventory or exempt from notification requirements.

Canadian WHMIS Classification: Class D, Division 2, Subdivision A (Very Toxic Material causing other Toxic Effects)

16: OTHER INFORMATION

European Community Labeling Classification: Harmful (Xn)

European Community Risk and Safety Phrases: R40, R48, S22

NFPA Hazard Rating: Health: 1 Fire: 0 Reactivity: 0

HMIS Hazard Rating: Health: * Fire: 0 Reactivity: 0

* Warning - Chronic health effect possible - inhalation of silica dust may cause lung injury/disease (silicosis). Take appropriate measures to avoid breathing dust. See Section 3.

References:

- Registry for Toxic Effects of Chemical Substances (RTECS), 1998
- Patty's Industrial Hygiene and Toxicology
- NTP Ninth Report on Carcinogens, 2000
- IARC Monograph Volume 68, Silica, Some Silicates and Organic Fibres, 1997

Revision Summary: New Product

The data in this Material Safety Data Sheet relates only to the specific material designated herein and does not relate to use in combination with any other material or in any process. The information set forth herein is based on technical data the Unimin Corporation believes reliable. It is intended for use by persons having technical skill and at their own discretion and risk. Since conditions of use are outside the control of Unimin Corporation, no warranties, expressed or implied, are made and no liability is assumed in connection with any use of this information. Any use of these data and information must be determined by the user to be in accordance with federal, state and local laws and regulations.

U. S. SILICA COMPANY

MSDS - MATERIAL SAFETY DATA SHEET

SECTION 1 - CHEMICAL PRODUCT AND COMPANY IDENTIFICATION

Product Names/Trade Names:

Silica Sand sold under various names: ASTM TESTING SANDS • GLASS SAND • FLINT SILICA • DM-SERIES • F-SERIES • FOUNDRY SANDS • FJ-SERIES • FP-SERIES • H-SERIES • L-SERIES • N-SERIES • NJ-SERIES • OK-SERIES • P-SERIES • T-SERIES • HYDRAULIC FRACING SANDS • MIN-U-SIL® Ground Silica • MYSTIC WHITE® • #1 DRY • #1 SPECIAL • PENN SAND® • Q-ROK® • SIL-CO-SIL® Ground Silica • SUPERSIL® • MASON SAND • GS-SERIES • PER-SPEC

Synonyms/Common Names: Sand, Silica Sand, Quartz, Crystalline Silica, Flint, Ground Silica.

Manufacturer's Name: U. S. Silica Company
P. O. Box 187
Berkeley Springs, WV 25411

Emergency Telephone Number: 304-258-2500 (8:30 am to 5:00 pm eastern)
304-258-8295 (fax)

Date Prepared: June 30, 2006 (revising February 10, 2005)

SECTION 2 - HAZARD IDENTIFICATION

EMERGENCY OVERVIEW:

The U. S. Silica Company material is a white or tan sand, or ground sand. It is not flammable, combustible or explosive. It does not cause burns or severe skin or eye irritation. A single exposure will not result in serious adverse health effects. Crystalline silica (quartz) is not known to be an environmental hazard.

Crystalline silica (quartz) is incompatible with hydrofluoric acid, fluorine, chlorine trifluoride or oxygen difluoride.

OSHA REGULATORY STATUS

This material is considered hazardous under the OSHA Hazard Communications Standard (29 CFR 1910.1200).

POTENTIAL HEALTH EFFECTS:

Inhalation:

- a. Silicosis Respirable crystalline silica (quartz) can cause silicosis, a fibrosis (scarring) of the lungs. Silicosis may be progressive; it may lead to disability and death.
- b. Lung Cancer Crystalline silica (quartz) inhaled from occupational sources is classified as carcinogenic to humans.
- c. Tuberculosis Silicosis increases the risk of tuberculosis.
- d. Autoimmune and Chronic Kidney Diseases Some studies show excess numbers of cases of scleroderma, connective tissue disorders, lupus, rheumatoid arthritis, chronic kidney diseases and end-stage kidney disease in workers exposed to respirable crystalline silica.
- e. Non-Malignant Respiratory Diseases (other than silicosis) Some studies show an increased incidence in chronic bronchitis and emphysema in workers exposed to respirable crystalline silica.

Eye Contact: Crystalline silica (quartz) may cause abrasion of the cornea.

Skin Contact: Not applicable.

Ingestion: Not applicable.

Chronic Effects: The adverse health effects -- silicosis, lung cancer, autoimmune and chronic kidney diseases, tuberculosis, and non-malignant respiratory diseases-- are chronic effects.

Signs and Symptoms of Exposure: Generally, there are no signs or symptoms of exposure to crystalline silica (quartz).

Medical Conditions Generally Aggravated by Exposure: The condition of individuals with lung disease (e.g., bronchitis, emphysema, chronic obstructive pulmonary disease) can be aggravated by exposure.

See Section 11, Toxicological Information, for additional detail on potential adverse health effects.

SECTION 3 - COMPOSITION/INFORMATION ON INGREDIENTS

Ingredients:

	<u>Chemical Formula</u>	<u>Typical %, By Weight</u>	<u>CAS #</u>
Crystalline Silica (quartz)	SiO ₂	99.0 - 99.9	14808-60-7
Aluminum Oxide	Al ₂ O ₃	< .8	1344-28-1
Iron Oxide	Fe ₂ O ₃	< .1	1309-37-1
Titanium Oxide	TiO ₂	< .1	13463-67-7

SECTION 4 - FIRST AID MEASURES

Inhalation: No specific first-aid is necessary since the adverse health effects associated with exposure to crystalline silica (quartz) result from chronic exposures. If there is a gross inhalation of crystalline silica (quartz), remove the person immediately to fresh air, give artificial respiration as needed, seek medical attention as needed.

Eye Contact: Wash immediately with water. If irritation persists, seek medical attention.

Skin Contact: Not applicable.

Ingestion: Not applicable.

SECTION 5 - FIRE FIGHTING MEASURES

Crystalline silica (quartz) is not flammable, combustible or explosive.

SECTION 6 - ACCIDENTAL RELEASE MEASURES

Spills: Use dustless methods (vacuum) and place into closable container for disposal, or flush with water. Do not dry sweep. Wear protective equipment specified below.

Waste Disposal Method: See Section 13.

SECTION 7 - HANDLING AND STORAGE

Precautions During Handling and Use: Do not breathe dust. Use adequate ventilation and dust collection. Keep airborne dust concentrations below permissible exposure limit ("PEL"). Do not rely on your sight to determine if dust is in the air. Respirable crystalline silica dust may be in the air without a visible dust cloud.

If crystalline silica dust cannot be kept below permissible limits, wear a respirator approved for silica dust when using, handling, storing or disposing of this product or bag. See Section 8 for further information on respirators. Practice good housekeeping. Do not permit dust to collect on walls, floors, sills, ledges, machinery, or equipment. Maintain, clean, and fit test respirators in accordance with OSHA regulations. Maintain and test ventilation and dust collection equipment. Wash or vacuum clothing that has become dusty.

The OSHA Hazard Communication Standard, 29 CFR Sections 1910.1200, 1915.1200, 1917.28, 1918.90, 1926.59 and 1928.21, and state and local worker or community "right-to-know" laws and regulations should be strictly followed.

Do not use U. S. Silica Company materials for sandblasting.

Precautions During Storage: Avoid breakage of bagged material or spills of bulk material. Use dustless methods (vacuum) and place into closable container for disposal, or flush with water. Do not dry sweep. See control measures in Section 8.

The OSHA Hazard Communication Standard, 29 CFR Sections 1910.1200, 1915.1200, 1917.28, 1918.90, 1926.59 and 1928.21, and state and local worker or community "right-to-know" laws and regulations should be strictly followed. **WARN YOUR EMPLOYEES (AND YOUR CUSTOMERS IN CASE OF RESALE) BY POSTING AND OTHER MEANS OF THE HAZARDS AND THE REQUIRED OSHA PRECAUTIONS. PROVIDE TRAINING FOR YOUR EMPLOYEES ABOUT THE OSHA PRECAUTIONS.**

For additional precautions, see American Society for Testing and Materials (ASTM) standard practice E 1132-99a, "Standard Practice for Health Requirements Relating to Occupational Exposure to Respirable Crystalline Silica."

SECTION 8 - EXPOSURE CONTROLS/PERSONAL PROTECTION

Local Exhaust Ventilation: Use sufficient local exhaust ventilation to reduce the level of respirable crystalline silica to below the OSHA PEL. See ACGIH "Industrial Ventilation, A Manual of Recommended Practice" (latest edition).

Respiratory Protection:

If it is not possible to reduce airborne exposure levels to below the OSHA PEL with ventilation, use the table below to assist you in selecting respirators that will reduce personal exposures to below the OSHA PEL. This table is part of the NIOSH Respirator Selection Logic, 2004, Chapter III, Table 1, "Particulate Respirators". The full document can be found at www.cdc.gov/niosh/npptl/topics/respirators; the user of this MSDS is directed to that site for information concerning respirator selection and use.

The assigned protection factor (APF) is the minimum anticipated level of protection provided by each type of respirator worn in accordance with an adequate respiratory protection program. For example, an APF of 10 means that the respirator should reduce the airborne concentration of a particulate by a factor of 10, so that if the workplace concentration of a particulate was 150 ug/m³, then a respirator with an APF of 10 should reduce the concentration of particulate to 15 ug/m³.

Assigned protection factor ¹	Type of Respirator (Use only NIOSH-certified respirators)
10	Any air-purifying elastomeric half-mask respirator equipped with appropriate type of particulate filter. ² Appropriate filtering facepiece respirator. ^{2,3} Any air-purifying full facepiece respirator equipped with appropriate type of particulate filter. ² Any negative pressure (demand) supplied-air respirator equipped with a half-mask.
25	Any powered air-purifying respirator equipped with a hood or helmet and a high efficiency (HEPA) filter. Any continuous flow supplied-air respirator equipped with a hood or helmet.
50	Any air-purifying full facepiece respirator equipped with N-100, R-100, or P-100 filter(s). Any powered air-purifying respirator equipped with a tight-fitting facepiece (half or full facepiece) and a high-efficiency filter. Any negative pressure (demand) supplied-air respirator equipped with a full facepiece. Any continuous flow supplied-air respirator equipped with a tight-fitting facepiece (half or full facepiece). Any negative pressure (demand) self-contained respirator equipped with a full facepiece.
1,000	Any pressure-demand supplied-air respirator equipped with a half-mask.

1. The protection offered by a given respirator is contingent upon (1) the respirator user adhering to complete program requirements (such as the ones required by OSHA in 29CFR1910.134), (2) the use of NIOSH-certified respirators in their approved configuration, and (3) individual fit testing to rule out those respirators that cannot achieve a good fit on individual workers.

2. Appropriate means that the filter medium will provide protection against the particulate in question.

3. An APF of 10 can only be achieved if the respirator is qualitatively or quantitatively fit tested on individual workers.

Exposure Guidelines:

Component	CAS No.	Percentage (by wt.)	OSHA PEL		ACGIH TLV		NIOSH REL		Unit
			TWA	STEL	TWA	STEL	TWA	STEL	
Crystalline Silica (quartz)	14808-60-7	99.0-99.9	$\frac{10}{\% \text{ SiO}_2 + 2}$	None	.025	None	.05	None	mg/m ³

If crystalline silica (quartz) is heated to more than 870°C, it can change to a form of crystalline silica known as tridymite; if crystalline silica (quartz) is heated to more than 1470°C, it can change to a form of crystalline silica known as cristobalite. The OSHA PEL for crystalline silica as tridymite or cristobalite is one-half of the OSHA PEL for crystalline silica (quartz).

SECTION 9 - PHYSICAL AND CHEMICAL PROPERTIES

Appearance:	White or tan sand; granular, crushed, or ground.		
Boiling Point:	4046°F/2230°C	Odor:	None
Vapor Pressure (mm Hg.):	None	Specific Gravity (Water = 1):	2.65
Vapor Density (Air = 1):	None	Melting Point:	3110°F/1710°C
Solubility in Water:	Insoluble in water	Evaporation Rate (Butyl Acetate = 1):	None

SECTION 10 - STABILITY AND REACTIVITY

Stability: Crystalline silica (quartz) is stable.

Incompatibility (Materials to Avoid): Contact with powerful oxidizing agents, such as fluorine, chlorine trifluoride and oxygen difluoride, may cause fires.

Hazardous Decomposition or Byproducts: Silica will dissolve in hydrofluoric acid and produce a corrosive gas - silicon tetrafluoride.

Hazardous Polymerization: Will not occur.

SECTION 11 - TOXICOLOGICAL INFORMATION

The method of exposure to crystalline silica that can lead to the adverse health effects described below is inhalation.

A. SILICOSIS

The major concern is silicosis, caused by the inhalation and retention of respirable crystalline silica dust. Silicosis can exist in several forms, chronic (or ordinary), accelerated, or acute.

Chronic or Ordinary Silicosis (often referred to as Simple Silicosis) is the most common form of silicosis, and can occur after many years of exposure to relatively low levels of airborne respirable crystalline silica dust. It is further defined as either simple or complicated silicosis.

Simple silicosis is characterized by lung lesions (shown as radiographic opacities) less than 1 centimeter in diameter, primarily in the upper lung zones. Often, simple silicosis is not associated with symptoms, detectable changes in lung function or disability.

Simple silicosis may be progressive and may develop into complicated silicosis or progressive massive fibrosis (PMF). Complicated silicosis or PMF is characterized by lung lesions (shown as radiographic opacities) greater than 1 centimeter in diameter. Although there may be no symptoms associated with complicated silicosis or PMF, the symptoms, if present, are shortness of breath, wheezing, cough and sputum production. Complicated silicosis or PMF may be associated with decreased lung function and may be disabling. Advanced complicated silicosis or PMF may lead to death. Advanced complicated silicosis or PMF can result in heart disease secondary to the lung disease (cor pulmonale).

Accelerated Silicosis can occur with exposure to high concentrations of respirable crystalline silica over a relatively short period; the lung lesions can appear within five (5) years of initial exposure. Progression can be rapid. Accelerated silicosis is similar to chronic or ordinary silicosis, except that lung lesions appear earlier and progression is more rapid.

Acute Silicosis can occur with exposures to very high concentrations of respirable crystalline silica over a very short time period, sometimes as short as a few months. The symptoms of acute silicosis include progressive shortness of breath, fever, cough and weight loss. Acute silicosis is fatal.

B. CANCER

IARC - The International Agency for Research on Cancer ("IARC") concluded that there was "*sufficient evidence* in humans for the carcinogenicity of crystalline silica in the forms of quartz or cristobalite from occupational sources", and that there is "*sufficient evidence* in experimental animals for the carcinogenicity of quartz and cristobalite." The overall IARC evaluation was that "crystalline silica inhaled in the form of quartz or cristobalite from occupational sources is *carcinogenic to humans (Group 1)*." The IARC evaluation noted that "carcinogenicity was not detected in all industrial circumstances studies. Carcinogenicity may be dependent on inherent characteristics of the crystalline silica or on external factors affecting its biological activity or distribution of its polymorphs." For further information on the IARC evaluation, see IARC Monographs on the Evaluation of Carcinogenic Risks to Humans, Volume 68, "Silica, Some Silicates..." (1997).

NTP - The National Toxicology Program's Eleventh Annual Report on Carcinogens classifies "silica, crystalline (respirable size)" as a known human carcinogen.

OSHA - Crystalline silica (quartz) is not regulated by the U. S. Occupational Safety and Health Administration as a carcinogen.

C. AUTOIMMUNE DISEASES

Several studies have reported excess cases of several autoimmune disorders, -- scleroderma, systemic lupus erythematosus, rheumatoid arthritis -- among silica-exposed workers. For a review of the subject, the following may be consulted: "Occupational Exposure to Crystalline Silica and Autoimmune Disease", Environmental Health Perspectives, Volume 107, Supplement 5, pp. 793-802 (1999); "Occupational Scleroderma", Current Opinion in Rheumatology, Volume 11, pp. 490-494 (1999).

D. TUBERCULOSIS

Individuals with silicosis are at increased risk to develop pulmonary tuberculosis, if exposed to persons with tuberculosis. The following may be consulted for further information: Occupational Lung Disorders, Third Edition, Chapter 12, entitled "Silicosis and Related Diseases", Parkes, W. Raymond (1994); "Risk of pulmonary tuberculosis relative to silicosis and exposure to silica dust in South African gold miners," Occup Environ Med., Volume 55, pp.496-502 (1998).

E. KIDNEY DISEASE

Several studies have reported excess cases of kidney diseases, including end stage renal disease, among silica-exposed workers. For additional information on the subject, the following may be consulted: "Kidney Disease and Silicosis", Nephron, Volume 85, pp. 14-19 (2000).

F. NON-MALIGNANT RESPIRATORY DISEASES

The reader is referred to Section 3.5 of the NIOSH Special Hazard Review cited below, for information concerning the association between exposure to crystalline silica and chronic bronchitis, emphysema and small airways disease. There are studies that disclose an association between dusts found in various mining occupations and non-malignant respiratory diseases, particularly among smokers. It is unclear whether the observed associations exist only with underlying silicosis, only among smokers, or result from exposure to mineral dusts generally (independent of the presence or absence of crystalline silica, or the level of crystalline silica in the dust).

Sources of information:

The NIOSH Hazard Review - Occupational Effects of Occupational Exposure to Respirable Crystalline Silica published in April 2002 summarizes and discusses the medical and epidemiological literature on the health risks and diseases associated with occupation exposures to respirable crystalline silica. The NIOSH Hazard Review should be consulted for additional information, and citations to published studies on health risks and diseases associated with occupational exposure to respirable crystalline silica. The NIOSH Hazard Review is available from NIOSH - Publications Dissemination, 4676 Columbia Parkway, Cincinnati, OH 45226, or by calling 1-800-35-NIOSH (1-800-356-4676), or through the NIOSH web site, www.cdc.gov/niosh/topics/silica, then click on the link "NIOSH Hazard Review: Health Effects of Occupational Exposure to Respirable Crystalline Silica".

SECTION 12 - ECOLOGICAL INFORMATION

Crystalline silica (quartz) is not known to be ecotoxic; i.e., there are no data that suggests that crystalline silica (quartz) is toxic to birds, fish, invertebrates, microorganisms or plant

SECTION 13 - DISPOSAL CONSIDERATIONS

General: The packaging and material may be landfilled; however, material should be covered to minimize generation of airborne dust.

RCRA: Crystalline silica (quartz) is not classified as a hazardous waste under the Resource Conservation and Recovery Act, or its regulations, 40 CFR §261 et seq.

The above applies to materials as sold by U. S. Silica Company. The material may be contaminated during use, and it is the responsibility of the user to assess the appropriate disposal of the used material.

SECTION 14 - TRANSPORT INFORMATION

Crystalline silica (quartz) is not a hazardous material for purposes of transportation under the U. S. Department of Transportation Table of Hazardous Materials, 49 CFR §172.101.

SECTION 15 - REGULATORY INFORMATION

UNITED STATES (FEDERAL AND STATE)

TSCA No.: Crystalline silica (quartz) appears on the EPA TSCA inventory under the CAS No. 14808-60-7.

RCRA: Crystalline silica (quartz) is not classified as a hazardous waste under the Resource Conservation and Recovery Act, or its regulations, 40 CFR §261 et seq.

CERCLA: Crystalline silica (quartz) is not classified as a hazardous substance under regulations of the Comprehensive Environmental Response Compensation and Liability Act (CERCLA), 40 CFR §302.

Emergency Planning and Community Right to Know Act (SARA Title III): Crystalline silica (quartz) is not an extremely hazardous substance under Section 302 and is not a toxic chemical subject to the requirements of Section 313.

Clean Air Act: Crystalline silica (quartz) mined and processed by U.S. Silica Company is not processed with or does not contain any Class I or Class II ozone depleting substances.

FDA: Silica is included in the list of substances that may be included in coatings used in food contact surfaces, 21 CFR §175.300(b)(3)(xxvi).

NTP: Respirable crystalline silica, primarily quartz dusts occurring in industrial and occupational settings, is classified as Known to be a Human Carcinogen.

OSHA Carcinogen: Crystalline silica (quartz) is not listed.

California Proposition 65: Crystalline silica (airborne particles of respirable size) is classified as a substance known to the State of California to be a carcinogen.

California Inhalation Reference Exposure Level (REL): California established a chronic REL of 3 ug for silica (crystalline, respirable). A chronic REL is an airborne level of a substance at or below which no adverse health effects are anticipated in individuals indefinitely exposed to the substance at that level.

Massachusetts Toxic Use Reduction Act: Silica, crystalline (respirable size, <10 microns) is “toxic” for purposes of the Massachusetts Toxic Use Reduction Act.

Pennsylvania Worker and Community Right to Know Act: Quartz is a hazardous substance under the Act, but it is not a special hazardous substance or an environmental hazardous substance.

CANADA

Domestic Substances List: U. S. Silica Company products, as naturally occurring substances, are on the Canadian DSL.

WHMIS Classification: D2A

OTHER

EINECS No.: 238-878-4

EEC Label (Risk/Safety Phrases): R 48/20, R 40/20, S22, S38

IARC: Crystalline silica (quartz) is classified in IARC Group 1.

Japan MITI: All of the components of this product are existing chemical substances as defined in the Chemical Substance Control Law.

Australian Inventory of Chemical Substances: All of the components of this product are listed on the AICS inventory or exempt from notification requirements.

National, state, provincial or local emergency planning, community right-to-know or other laws, regulations or ordinances may be applicable--consult applicable national, state, provincial or local laws.

SECTION 16 - OTHER INFORMATION

Hazardous Material Information System (HMIS):

Health	*
Flammability	0
Reactivity	0
Protective Equipment	E

* For further information on health effects, see Sections 2 and 11 of this MSDS.

National Fire Protection Association (NFPA):

Health	0
Flammability	0
Reactivity	0

Web Sites with Information about Effects of Crystalline Silica Exposure:

The U. S. Silica web site will provide updated links to OSHA and NIOSH web sites addressing crystalline silica issues. www.u-s-silica.com, click in "Information", then click on "Health & Safety".

U. S. SILICA COMPANY DISCLAIMER

The information and recommendations contained herein are based upon data believed to be correct. However, no guarantee or warranty of any kind, express or implied, is made with respect to the information contained herein. We accept no responsibility and disclaim all liability for any harmful effects that may be caused by purchase, resale, use or exposure to our silica. Customers-users of silica must comply with all applicable health and safety laws, regulations, and orders, including the OSHA Hazard Communication Standard.



MATERIAL SAFETY DATA SHEET

MSDS No. M0372

Effective Date: 10/05/2007

1. IDENTIFICATION OF THE PRODUCT AND OF THE COMPANY

Trade Names: ISOFRAX® 1260C PAPER
Chemical Name: ALKALINE EARTH SILICATE WOOL (AES)
Synonym(s): Synthetic vitreous fiber (SVF), man-made vitreous fiber (MMVF), man-made mineral fiber (MMMf), alkaline-earth-silicate fiber, magnesium silicate fiber
Manufacturer/Supplier: Unifrax I LLC
 2351 Whirlpool St.
 Niagara Falls, NY 14305-2413
Product Stewardship Information Hotline
 1-800-322-2293 (Monday - Friday 8:00 a.m. - 4:30 p.m. EST)
 For additional MSDSs, visit our web page, <http://www.unifrax.com>, or call Unifrax Customer Service at (716) 278-3872
CHEMTREC Assist: CHEMTREC will provide assistance for chemical emergencies. Call 1-800-424-9300

2. COMPOSITION / INFORMATION ON INGREDIENTS

<u>COMPONENTS</u>	<u>CAS NUMBER</u>	<u>% BY WEIGHT</u>
Amorphous alkaline-earth-silicate (magnesium-silicate) wool (SiO ₂ 70-80 %, MgO 18-27 %, trace elements 0-4%)	436083-99-7	80-90
Acrylic latex	MIXTURE 10043-01-3	5-10 0-5
Aluminum sulfate		

(See Section 8 "Exposure Controls / Personal Protection" for exposure guidelines)

3. HAZARDS IDENTIFICATION

MAY IRRITATE EYES, SKIN and RESPIRATORY TRACT

May cause temporary mechanical irritation to eyes, skin, and respiratory tract (nose, throat & lungs).

Pre-existing medical conditions, including dermatitis, asthma or chronic lung disease may be aggravated by exposure; individuals who are atopic (with a history of allergies) may experience greater amounts of skin and respiratory irritation.

HAZARD CLASSIFICATION

The Hazardous Materials Identification System (HMIS) –

Health 1 Flammability 0 Reactivity 0 Personal Protection Index: X (Employer Determined)

4. FIRST AID MEASURES

FIRST AID PROCEDURES

RESPIRATORY TRACT (nose & throat) IRRITATION:

If respiratory tract irritation develops, move the person to a dust free location. Get medical attention if the irritation continues. See Section 8 for additional measures to reduce or eliminate exposure.

EYE IRRITATION:

If eyes become irritated, flush immediately with large amounts of lukewarm water for at least 15 minutes. Eyelids should be held away from the eyeball to ensure thorough rinsing. Do not rub eyes. Get medical attention if irritation persists.

SKIN IRRITATION:

If skin becomes irritated, remove soiled clothing. Do not rub or scratch exposed skin. Wash area of contact thoroughly with soap and water. Using a skin cream or lotion after washing may be helpful.

GASTROINTESTINAL IRRITATION:

If gastrointestinal tract irritation develops, move the person to a dust free environment.

NOTES TO PHYSICIANS:

Skin and respiratory effects are the result of temporary, mild mechanical irritation; fiber exposure does not result in allergic manifestations.

5. FIRE FIGHTING MEASURES

Non-combustible (does not burn) product.

Packaging and surrounding materials may be combustible.
Use extinguishing agent suitable for surrounding combustible materials.

6. ACCIDENTAL RELEASE MEASURES

SPILL PROCEDURES

Avoid creating airborne dust. Dust suppressing cleaning methods such as wet sweeping or vacuuming should be used to clean the work area. If vacuuming, the vacuum must be equipped with a HEPA filter. Compressed air or dry sweeping should not be used for cleaning.

7. HANDLING AND STORAGE

STORAGE

Store in original container in a dry area. Keep container closed when not in use.

HANDLING

Handle fiber carefully. Limit use of power tools unless in conjunction with local exhaust. Use hand tools whenever possible. Frequently clean the work area with HEPA filtered vacuum or wet sweeping to minimize the accumulation of debris. Do not use compressed air for clean-up.

EMPTY CONTAINERS

Product packaging may contain residue. Do not reuse.

8. EXPOSURE CONTROL / PERSONAL PROTECTION

INDUSTRIAL HYGIENE STANDARDS AND OCCUPATIONAL EXPOSURE LIMITS

COMPONENTS	OSHA PEL	MANUFACTURER REG
Amorphous alkaline-earth-silicate (magnesium-silicate) wool	None established	See below**
Acrylic latex	None established	None established
Aluminum sulfate	None established	None established

There is no specific regulatory standard for ISOFRAX® in the U.S. OSHA's "Particulate Not Otherwise Regulated (PNOR)" standard [29 CFR 1910.1000, Subpart Z, Air Contaminants] applies generally; Total Dust 15 mg/m³; Respirable Fraction 5 mg/m³.

OTHER OCCUPATIONAL EXPOSURE LEVELS (OEL)

ACGIH TLV's : Amorphous alkaline-earth-silicate (magnesium-silicate) wool -- Particulates Not Otherwise Classified (PNOC) : Inhalable particulate -- 10 mg/m³. Respirable particulate -- 3 mg/m³. Acrylic latex -- None established. Aluminum sulfate -- None established.

** As with most industrial materials, it is prudent to minimize unnecessary exposure to respirable dusts. Note that Industrial hygiene standards and occupational exposure limits differ between countries and local jurisdictions. Check with your employer to identify any "respirable dust", "total dust" or "fiber" exposure standards to follow in your area. If no regulatory dust or fiber control standard apply, a qualified industrial hygiene professional can assist with a specific evaluation of workplace conditions and the identification of appropriate respiratory protection practices. In the absence of other guidance, the supplier has found that it is generally feasible to control occupational fiber exposure to 1 f/cc or less.

ENGINEERING CONTROLS:

Dust suppressing control technologies such as local exhaust ventilation, point of generation dust collection, down draft work stations, emission controlling tool designs, and materials handling equipment are effective means of minimizing airborne fiber emissions. For additional information, contact the Unifrax Product Stewardship Information Line at 1-800-322-2293 (See Section 16).

PERSONAL PROTECTION EQUIPMENT

Skin Protection:

Wear gloves, head coverings and full body clothing as necessary to prevent skin irritation. Washable or disposable clothing may be used. If possible, do not take unwashed clothing home. If soiled work clothing must be taken home, employers should ensure employees are thoroughly trained on the best practices to minimize or avoid non-work dust exposure (e.g., vacuum clothes before leaving the work area, wash work clothing separately, rinse washer before washing other household clothes, etc.).

Eye Protection:

Wear safety glasses with side shields or other forms of eye protection in compliance with appropriate OSHA standards to prevent eye irritation. The use of contact lenses is not recommended, unless used in conjunction with appropriate eye protection. Do not touch eyes with soiled body parts or materials. If possible, have eye-washing facilities readily available where eye irritation can occur.

Respiratory Protection:

When effective engineering and/or administrative controls are insufficient, the use of appropriate respiratory protection, pursuant to the requirements of OSHA 1910.134, is recommended. For dust concentrations below the applicable exposure limit value, PPE is not required. The evaluation of workplace hazards and the identification of appropriate respiratory protection is best performed on a case by case basis, by a qualified Industrial Hygienist.

9. PHYSICAL AND CHEMICAL PROPERTIES

ODOR AND APPEARANCE:	White, odorless, fibrous material
CHEMICAL FAMILY:	Alkaline Earth Silicate Wool (AES) Magnesium Silicate
BOILING POINT:	Not Applicable
WATER SOLUBILITY (%):	Not Soluble in Water
MELTING POINT:	1500-1550°C (2730-2820°F)
SPECIFIC GRAVITY:	2.60
VAPOR PRESSURE:	Not Applicable
pH:	Not Applicable
VAPOR DENSITY (Air = 1):	Not Applicable
% VOLATILE:	Not Applicable
MOLECULAR FORMULA:	SiO ₂ MgO.

10. STABILITY AND REACTIVITY

CHEMICAL STABILITY:	Stable under conditions of normal use.
INCOMPATIBILITY:	Avoid direct contact with strong acid environments.
CONDITIONS TO AVOID:	None.
HAZARDOUS DECOMPOSITION PRODUCTS:	
HAZARDOUS POLYMERIZATION:	Not Applicable.

11. TOXICOLOGICAL INFORMATION

EPIDEMIOLOGY

This product has not been the subject of epidemiological study. Epidemiological studies related to other fiber chemistries of similar solubility have not identified a statistically significant incidence of exposure-related respiratory disease.

TOXICOLOGY

This product has been the subject of limited testing.

A review of available scientific literature suggests an inverse relationship between dissolution rate and potential health effects; i.e. the higher the dissolution rate of a fiber the lower its potential to produce health effects. The dissolution rate of ISOFRAX® fiber has been determined through standardized *in vitro* testing. The dissolution rate of ISOFRAX® fibers is higher than that of other fiber types that have been tested in chronic animal studies and did not produce respiratory disease.

This product possesses a fiber chemistry within the regulatory (European Commission Directive 97/69/EC) definition as a "man-made vitreous (silicate) fiber with random orientation with alkaline oxide and alkaline earth oxide (Na₂O + K₂O + CaO + MgO + BaO) content greater than 18% by weight". ISOFRAX® fibers have been tested pursuant to EU protocol ECB/TM/26, rev. 7, Nota Q, Directive 97/69/EC. The results for the short term biopersistence test by inhalation (IH test) was 6 days; well below the regulatory threshold of 10 days cited in Directive 97/69/EC. Based on testing results, ISOFRAX® based products are not regarded as potential carcinogens and they ARE EXEMPT from European classification as such. By virtue of these test results, these products ARE EXEMPT from European regulatory guidelines that require hazard warning labels with specific risk phrases citing respiratory disease potential. In addition, ISOFRAX® fibers have been tested in an independent laboratory, by intratracheal (IT test) instillation, under a protocol that was consistent with the requirements of the German Hazardous Substances Ordinance (BGBI. I pp. 1782, 2049, Third Amendment, Appendix V, No. 7). The half-life clearance of Isofrax® fibers was 32.7 days; well below the applicable regulatory thresholds. Based on the IT test results, Isofrax products ARE EXEMPT from the requirements of the German Ordinance.

The definition of "irritant" contained in the hazard communication standard, 29 CFR 1900.1200, Appendix A, is "...a reversible inflammatory effect on living tissue by chemical action...". ISOFRAX® fiber is an inert material which doesn't interact chemically

with exposed skin. However, there is a possibility that exposure to this product may cause temporary mechanical irritation to the eyes, skin or respiratory tract (nose, throat, lungs). This temporary irritation can be mitigated with proper handling practices designed to limit exposure and the use of protective clothing (glasses, gloves, clothing).

This product has not been specifically evaluated by any regulatory authority or other classification entity, such as the International Agency for Research on Cancer (IARC) or the National Toxicology Program (NTP). Other types of man-made vitreous fibers (MMVF) have been evaluated and subsequently classified as potential carcinogens. Various classifications, such as "possible carcinogen", "probable carcinogen", and "reasonably anticipated to be a carcinogen" have been given to other MMVF's.

12. ECOLOGICAL INFORMATION

No ecological concerns have been identified.

13. DISPOSAL CONSIDERATIONS

WASTE MANAGEMENT

To prevent waste materials from becoming airborne during waste storage, transportation and disposal, a covered container or plastic bagging is recommended.

DISPOSAL

ISOFRAX® fiber, as manufactured, is not classified as a hazardous waste according to Federal regulations (40 CFR 261). Any processing, use, alteration or chemical additions to the product, as purchased, may alter the disposal requirements. Under Federal regulations, it is the waste generator's responsibility to properly characterize a waste material, to determine if it is a "hazardous" waste. Check local, regional, state or provincial regulations to identify all applicable disposal requirements.

EUROPEAN UNION

Waste from this product is not classified as "hazardous" or "special" under European Union regulations. Disposal is permitted at landfills licensed for industrial waste.

14. TRANSPORT INFORMATION

U.S. DEPARTMENT OF TRANSPORTATION (DOT)

Hazard Class:	Not Regulated	United Nations (UN) Number:	Not Applicable
Labels:	Not Applicable	North America (NA) Number:	Not Applicable
Placards:	Not Applicable	Bill of Lading:	Product Name

INTERNATIONAL

Canadian TDG Hazard Class & PIN: Not regulated
Not classified as dangerous goods under ADR (road), RID (train) or IMDG (ship).

15. REGULATORY INFORMATION

UNITED STATES REGULATIONS

EPA: **Superfund Amendments and Reauthorization Act (SARA)** Title III - This product does not contain any substances reportable under Sections 302, 304, 313, (40 CFR 372). Sections 311 and 312 (40 CFR 370) apply (delayed hazard).
Toxic Substances Control Act (TSCA) - All substances in this product are listed, as required, on the TSCA inventory.

Comprehensive Environmental Response, Compensation and Liability Act (CERCLA) and the Clean Air Act (CAA) - ISOFRAX® contains fibers with an average diameter greater than one micron and thus is not considered a hazardous air pollutant.

OSHA: Comply with **Hazard Communication Standards** 29 CFR 1910.1200 and 29 CFR 1926.59 and the **Respiratory Protection Standards** 29 CFR 1910.134 and 29 CFR 1926.103.

States: ISOFRAX® products are not known to be regulated. However, state and local OSHA and EPA regulations may apply to these products. If in doubt, contact your local regulatory agency.

INTERNATIONAL REGULATIONS

Canada: **Canadian Workplace Hazardous Materials Information System (WHMIS):**
No Canadian Workplace Hazardous Materials Information System (WHMIS) categories apply to this product.
Canadian Environmental Protection Act (CEPA) - All substances in this product are listed, as required, on the Domestic Substance List (DSL)

European Union: **European Directive 97/69/EC** - By virtue of testing results, ISOFRAX® fiber has been exempted from classification and labeling as a potential carcinogen.

16. OTHER INFORMATION

After-Service ISOFRAX® Thermal Insulation: Removal

As produced, Isofrax fibers are vitreous (glassy) materials, which upon continued exposure to elevated temperatures (above about 800°C) might devitrify, initially forming magnesia-bearing phases (enstatite). At higher temperatures, (above about 1000°C) crystalline phase silicas may occur. The occurrence and extent of crystalline phase formation is dependent on the duration and temperature of exposure, fiber chemistry and/or the presence of fluxing agents. The presence of crystalline phases can be confirmed only through laboratory analysis of the "hot-face" fiber.

IARC's evaluation of crystalline silica states "Crystalline silica inhaled in the form of quartz or cristobalite from occupational sources is carcinogenic to humans (Group 1)" and additionally notes "carcinogenicity in humans was not detected in all industrial circumstances studied" (IARC Monograph Vol. 68, 1997). NTP lists all polymorphs of crystalline silica amongst substances which may "reasonably be anticipated to be carcinogens".

During removal operations, the use of a full face respirator is recommended to reduce inhalation exposure along with eye & respiratory tract irritation. A specific evaluation of workplace hazards and the identification of appropriate respiratory protection is best performed, on a case by case basis, by a qualified industrial hygiene professional. For more detailed information regarding respirable crystalline silica, call the Product Stewardship Information Hotline (see below).

PRODUCT STEWARDSHIP PROGRAM

Unifrax has established a program to provide customers with up-to-date information regarding the proper use and handling of fiber-based products, including ISOFRAX® THERMAL INSULATION. In addition, Unifrax has also established a program to monitor airborne fiber concentrations at customer facilities. If you would like more information about this program, please call the Unifrax Product Stewardship Information Line at 1-800-322-2293.

DEFINITIONS

ACGIH: American Conference of Governmental Industrial Hygienists

ADR:	Carriage of Dangerous Goods by Road (International Regulation)
CAA:	Clean Air Act
CAS:	Chemical Abstracts Service
CERCLA:	Comprehensive Environmental Response, Compensation and Liability Act
DSL:	Domestic Substances List
EPA:	Environmental Protection Agency
EU:	European Union
f/cc:	Fibers per cubic centimeter
HEPA:	High Efficiency Particulate Air
HMIS:	Hazardous Materials Identification System
IARC:	International Agency for Research on Cancer
IATA:	International Air Transport Association
IMDG:	International Maritime Dangerous Goods Code
mg/m³:	Milligrams per cubic meter of air
mmpcf:	Million particles per cubic meter
NFPA:	National Fire Protection Association
NIOSH:	National Institute for Occupational Safety and Health
OSHA:	Occupational Safety and Health Administration
29 CFR 1910.134 & 1926.103:	OSHA Respiratory Protection Standards
29 CFR 1910.1200 & 1926.59:	OSHA Hazard Communication Standards
PEL:	Permissible Exposure Limit (OSHA)
PIN:	Product Identification Number
PNOC:	Particulates Not Otherwise Classified
PNOR:	Particulates Not Otherwise Regulated
PSP:	Product Stewardship Program
RCRA:	Resource Conservation and Recovery Act
REL:	Recommended Exposure Limit (NIOSH)
RID:	Carriage of Dangerous Goods by Rail (International Regulations)
SARA:	Superfund Amendments and Reauthorization Act
SARA Title III:	Emergency Planning and Community Right to Know Act
SARA Section 302:	Extremely Hazardous Substances
SARA Section 304:	Emergency Release
SARA Section 311:	MSDS/List of Chemicals and Hazardous Inventory
SARA Section 312:	Emergency and Hazardous Inventory
SARA Section 313:	Toxic Chemicals and Release Reporting
STEL:	Short Term Exposure Limit`
SVF:	Synthetic Vitreous Fiber
TDG:	Transportation of Dangerous Goods
TLV:	Threshold Limit Value (ACGIH)
TSCA:	Toxic Substances Control Act
TWA:	Time Weighted Average
WHMIS:	Workplace Hazardous Materials Information System (Canada)

Revision Summary: Updated corporate name. Added "wool" to CAS nomenclature. Replaces 05/19/05 MSDS.

MSDS Prepared By: UNIFRAX RISK MANAGEMENT DEPARTMENT

DISCLAIMER

The information presented herein is presented in good faith and believed to be accurate as of the effective date of this Material Safety Data Sheet. Employers may use this MSDS to supplement other information gathered by them in their efforts to assure the health and safety of their employees and the proper use of the product. This summary of the relevant data reflects professional judgment; employers should note that information perceived to be less relevant has not been included in this MSDS. Therefore, given the summary nature of this document, Unifrax I LLC does not extend any warranty (expressed or implied), assume any responsibility, or make any representation regarding the completeness of this information or its suitability for the purposes envisioned by the user.



Date: 9/6/2005
MSDS ID: 20509
Rev: 1.0.3
Replaces: 4/1/2003

Material Safety Data Sheet

Material Name: Fire Resistant Mineral Wool Insulation

Section 1— Chemical Product and Company Identification

Product Name(s): MinWool-1200™ Board, Flex, Blanket, Pipe, Sound Attenuation Fire Batts, Safing, Curtainwall, Pipe and Tank

Manufacturer Information
Industrial Insulation Group MinWool
908 John Bussey Drive
Phenix City, AL 36869
Web site: www.iig-llc.com

Trade Names: MinWool-1200

Phone number for Health and Safety Information: 970.858.6211 (M-F, 7am to 4 pm, Mountain Time)

Section 2 — Composition and Information on Ingredients

CAS #	Component	Percent	OSHA PEL	ACGIH TLV	NIOSH REL
65997-17-3	Synthetic Vitreous Fiber	95+	15(T) 5(R) mg/M ³	1f/cc	NE
25104-55-6	Cured Urea Formaldehyde/Phenol Binder	0-5	NE	NE	NE

ACGIH TLVs are 2003 values. OSHA PELs are those in effect on the date of preparation of this MSDS. The listed PELs, TLVs and RELs are time weighted average exposure limits.

Component Related Regulatory Information

This product may be regulated, have exposure limits or other information identified as the following:

Nuisance Particulates, Rock Wool Fibers

Section 3 — Hazards Identification

Emergency Overview:

Appearance and Odor: Commercial Board, Batt, and Pipe insulation is solid, green/yellow.

This product is an article and under normal conditions of use, this product is not expected to create any unusual emergency hazards. However, cutting, sawing, or abrading may increase the risk of personnel exposure.

Inhalation of excessive amounts of dust created when fabricating, cutting, or other mechanical alterations of the product may cause temporary upper respiratory irritation and/or congestion— remove affected individuals to fresh air.

Skin irritation may be treated by gently washing affected area with soap and warm water.

Eye irritation may be treated by flushing eyes with large amounts of water. If irritation persists, contact a physician.

Prolonged contact with dust from this product may cause Dermatitis.

Acrid smoke may be generated in a fire, use normal fire fighting procedures to prevent inhalation of smoke and gases.

HMIS Rating: Health: 0, Fire: 0, Reactivity 0, Other: 0

NFPA Rating: Health: 0, Flammability: 0, Reactivity: 0

WHMIS Class: IIG MinWool-1200 products are not controlled products

Potential Health Effects

Summary

Breathing dust from this product may cause a scratchy throat, congestion, and slight coughing.

Getting dust or fibers on the skin, or in the eyes may cause itching, rash, or redness.

Breathing large amounts of dust or fibers from this product may lead to chronic health effects as discussed in Section 11 of this material safety data sheet.

Inhalation:

If inhaled, remove the affected person to fresh air. If irritation persists, seek medical attention.

Skin Contact:

Dusts and fibers from this product may cause temporary mechanical irritation to the skin.

Eye Contact:

Dusts and fibers from this product may cause temporary mechanical irritation to the eyes.

Ingestion:

This product is not intended to be ingested or eaten under normal conditions of use. If ingested, it may cause temporary irritation to the gastrointestinal (GI) tract, especially the stomach.

Target Organs

Upper respiratory passages, skin, and eyes.

Primary Routes of Entry (Exposure)

Inhalation (breathing dust), skin, and eye contact.

Medical Conditions Aggravated by Exposure:

Chronic respiratory or skin conditions may temporarily worsen from exposure to this product.

Section 4 — First Aid Measure

First Aid: Inhalation

Remove to fresh air. Drink water to clear throat, and blow nose to remove dust. If irritation persists, get medical attention.

First Aid: Skin

Wash gently with soap and warm water to remove dust. Use a wash cloth to help remove fibers. To avoid further irritation, do not rub or scratch affected areas. Rubbing or scratching may force fibers into the skin. If irritation persists get medical attention. Never use compressed air to remove fibers from the skin. Wash hands before eating or using the restroom.

First Aid: Ingestion

Product is not intended to be ingested or eaten. If this product is ingested, irritation of the gastrointestinal (GI) tract may occur, and should be treated symptomatically. Watch the person for several days to make sure that partial or complete intestinal obstruction does not occur. Do not induce vomiting unless directed to do so by medical personnel. Rinse mouth with water to remove fibers, and drink plenty of water to help reduce the irritation. No chronic effects are expected following ingestion.

First Aid: Eyes

Do not rub or scratch your eyes. Fibers may cause the eye to be scratched. Flush eyes with large amounts of water for at least 15 minutes. If irritation persists, contact a medical professional.

First Aid: Notes to Physician

This product is a mechanical irritant, and is not expected to produce any chronic health effects from acute exposures. Treatment should be directed toward removing the source of irritation with symptomatic treatment as necessary.

Section 5 — Fire Fighting Measures

Flash Point: Not applicable
Upper Flammable Limit (UFL): Not applicable
Auto Ignition: Not determined
Rate of Burning: Not applicable

Method Used: Not applicable
Lower Flammable Limit (LFL): Not applicable
Flammability Classification: Non combustible

General Fire Hazard

There is no potential for fire or explosion.

Extinguishing Media

Use any extinguishing media appropriate for the surrounding fires

Fire Fighting Equipment/Instructions

No special procedures are expected to be necessary for this product. Normal fire fighting procedures should be followed to avoid inhalation of smoke and gases produced by other materials.

Hazardous Combustion Products:

Primary combustion products are carbon monoxide, carbon dioxide, ammonia, and water. Other undetermined compounds could be released in small quantities.

Section 6 — Accidental Release Measures

Containment Procedures

Pick up large pieces. Vacuum dusts. If sweeping is necessary, use a dust suppressant such as water. Do not dry sweep dust accumulation or use compressed air for clean-up. These procedures will help to minimize potential exposures. This material will sink and disperse along the bottom of waterways and ponds. It can not easily be removed after it is waterborne; however, the material is non-hazardous in water.

Clean-Up Procedures

Wastes are not hazardous as defined by the RCRA (40 CFR 261). Comply with state and local regulations for disposal of these products. If you are unsure of the regulations, contact your local Public Health Department, or the local office of the EPA.

Section 7 — Handling and Storage

Handling Procedures

Use protective equipment as described in Section 8 of this material safety data sheet when handling uncontained material. Keep product in its packaging, as long as practicable to minimize potential dust generation. Keep work areas clean. Avoid unnecessary handling of scrap materials by placing them in waste disposal containers and equipment, kept as to close working areas as possible, to prevent release of fibers and dust. Good housekeeping practices should be used to prevent generation and accumulation of dusts. After handling product, wash face and hands before eating, drinking, or smoking.

Storage Procedures

Warehouse storage should be in accordance with package directions, if any. Material should be kept dry, and protected from the elements.

Section 8 — Exposure Control and Personal Protection

General Product Information

Follow all applicable exposure limits and use OSHA-recommended equipment and work practices. A complete copy of these practices can be obtained from IIG MinWool LLC (see Section 1 of this Material Safety Data Sheet), and is also available on the OSHA website (<http://www.osha.gov/SLTC/syntheticmineralfibers>).

Personal Protective Equipment

Personal Protective Equipment: Eyes/Face

Safety glasses with side shields are recommended to keep dust out of the eyes.

Personal Protective Equipment: Skin

Leather or cotton gloves should be worn to prevent skin contact and irritation. Barrier creams may also be used to reduce skin contact and irritation caused by mineral wool fibers. Normal work clothing (long sleeved shirts and long pants) is recommended. Skin irritation is known to occur chiefly at the pressure points such as around the neck, wrists, waist and between the fingers.

Personal Protective Equipment: Respiratory

A respirator should be used if ventilation is unavailable, or is inadequate for keeping dust and fiber levels below the applicable exposure limits. In those cases, use a NIOSH-certified disposable or reusable particulate respirator with an efficiency rating of N95 or higher (under 42 CFR 84) when working with this product. For exposures up to five times the established exposure limits use a quarter-mask respirator, rated N95 or higher; and for exposures up to ten times the established exposure limits use a half-mask respirator (e.g., MSA's DM-11, Racal's Delta N95, 3M's 8210), rated N95 or higher.

Operations such as sawing, blowing, tear out, and spraying may generate airborne fiber concentrations requiring a higher level of respiratory protection. For exposures up to 50 times the established exposure limits use a full-face respirator, rated N99 or higher.

Ventilation

In fixed manufacturing settings, local exhaust ventilation should be provided at areas of cutting to remove

airborne dust and fibers. General dilution ventilation should be provided as necessary to keep airborne dust and fibers below the applicable exposure limits and guidelines. The need for ventilation systems should be evaluated by a professional industrial hygienist, while the design of specific ventilation systems should be conducted by a professional engineer.

Personal Protective Equipment: General

Loose-fitting, long-sleeved clothing should be worn to protect the skin from irritation. Exposed skin areas should be washed with soap and warm water after handling.

Section 9 — Physical & Chemical Properties

Appearance: Fibrous semi-circle, blanket, or board insulation.

Odor:	Organic	pH:	Not applicable
Physical State:	Solid	Vapor Density:	Not applicable
Vapor Pressure:	Not applicable	Melting Point:	Not determined
Boiling Point:	Not applicable	Specific Gravity:	Not determined
Solubility (H2O):	Nil	Freezing Point:	Not applicable
Viscosity:	Not applicable	Evaporation Rate:	Not applicable
VOC:	Not applicable	Percent Volatile:	0

Section 10 — Chemical Stability & Reactivity Information

Chemical Stability

This is a stable material. This product is not reactive.

Hazardous Decomposition

None.

Hazardous Polymerization

Will not occur.

Incompatible Materials:

This product reacts with hydrofluoric acid.

Hazardous Decomposition Products:

Primary combustion products are carbon monoxide, carbon dioxide, ammonia, and water. Other undetermined compounds could be released in small quantities.

Section 11 — Toxicological Information

Acute Toxicity

A: General Product Information

Dusts may cause mechanical irritation to eyes and skin. Ingestion may cause transient irritation of throat, stomach and gastrointestinal tract. Inhalation may cause coughing, nose and throat irritation, and sneezing. Higher exposures may cause difficulty breathing, congestion, and chest tightness.

B: Component Analysis - LD50/LC50

No LD50/LC50's are available for this product.

Carcinogenicity

A: General Product Information

OSHA, NTP, IARC, and ACGIH have not classified this product in its entirety as a carcinogen.

B: Component Analysis - LD50/LC50

Cured Urea/formaldehyde/phenol binder (25104-55-6)

Oral LD50 Rat : 7 gm/kg

Oral LD50 Mouse : 7 gm/kg

Carcinogenicity:

A: General Product Information

In October 2001 the IARC concluded its re-evaluation of the carcinogenic risk of mineral wool fibers. The result was a reclassification of the fibers from Group 2B (possibly carcinogenic to humans) to Group 3 (not classifiable as to the carcinogenicity to humans). Epidemiological studies published during the 15 years prior to the 2001 IARC review provide no evidence of increased risk of cancer from occupational exposure during manufacture or use of mineral wool fiber.

B: Component Carcinogenicity

ACGIH, IARC, OSHA, and NTP carcinogen lists have been checked for those components with CAS registry numbers.

Synthetic Vitreous Fiber (65997-17-3)

ACGIH: A3 - animal carcinogen (related to rock wool fibers) with unknown relevance to humans

IARC: Monograph 43, 1988 (related to Glass filaments) (Group 3 (not classifiable))

Section 12 — Ecological Information

Ecotoxicity

A: General Product Information

No data available for this product.

B: Component Analysis - Ecotoxicity - Aquatic Toxicity

No ecotoxicity data are available for this product's components.

Section 13 — Disposal Considerations

US EPA Waste Number & Descriptions

A: General Product Information

This product, as supplied, is not regulated as a hazardous waste by the U.S. EPA under RCRA regulations.

Comply with state and local regulations for disposal. If you are unsure of the regulations, contact your local Public Health Department, or the local office of the EPA.

B: Component Waste Numbers

No EPA Waste Numbers are applicable for this product's components.

Disposal Instructions

Dispose of waste material according to Local, State, Federal, and Provincial Environmental Regulations.

Section 14 — Transport Information

US DOT Information

Shipping Name: This product is not classified a hazardous material for transport.

Section 15 — Regulatory Information

US Federal Regulations

A: General Product Information

No information on this product as a whole. Formaldehyde content is below the SARA 313 0.1% 'de minimis' concentration.

B: Component Analysis

This material contains one or more of the following chemicals required to be identified under SARA Section 302 (40 CFR 355 Appendix A), SARA Section 313 (40 CFR 372.65) and/or CERCLA (40 CFR 302.4).

Synthetic Vitreous Fiber(65997-17-3)

CERCLA: Includes mineral fiber emissions from facilities manufacturing or processing glass rock or slag fibers (or other mineral derived fibers) of average diameter 1 micrometer or less; Statutory RQ = 1 pound (.454 kg); no final RQ is being assigned to the generic or broad class (related to Fine mineral fibers)

State Regulations

A: General Product Information

The following statement(s) are provided under the California Safe Drinking Water and Toxic Enforcement Act of 1986 (Proposition 65): **WARNING!** This product contains a chemical known to the state of California to cause cancer.

Other Regulatory Information

A: General Product Information

No information available for the product.

B: TSCA Status

All ingredients of this product are included in the US EPA Chemical Substance Inventory or are not required to be listed.

C: CERCLA

Includes mineral fiber emissions from facilities manufacturing or processing glass rock or slag fibers (or other mineral derived fibers) of average diameter 1 micrometer or less; Statutory RQ = 1 pound (.454 kg); no final RQ is being assigned to the generic or broad class (related to Fine mineral fibers).

D: Clean Air Act

Mineral wool fiber appears on the Clean Air Act-1990 Hazardous Air Pollutants List.

International Regulations

A: General Product Information

Canada Workplace Hazardous Materials Information System (WHMIS)

WHMIS Classification: D2B– Irritant

Product classified as a manufactured article as defined in Hazardous Product Act (HPA), Section 11(1). Section 12(l) exempts it from the WHMIS supplier label and MSDS requirements of the Act.

B: Component Analysis - WHMIS IDL

No components are listed in the WHMIS IDL.

Section 16 — Other Information

Information about “Health and Safety Research on Rock- and Slag-wool” can be obtained from the North American Insulation Manufacturers Association (NAIMA), 44 Canal Center Plaza, Suite 310, Alexandria, VA 22314, or on the web at <http://www.naima.org>

This product has been classified according to the hazard criteria of the CPR and the MSDS contains all the information required by the CPR.

Key/Legend:

EPA = Environmental Protection Agency; TSCA = Toxic Substance Control Act; ACGIH = American Conference of Governmental Industrial Hygienists; IARC = International Agency for Research on Cancer; NIOSH = National Institute for Occupational Safety and Health; NTP = National Toxicology Program; OSHA = Occupational Safety and Health Administration; NFPA = National Fire Protection Association; HMIS = Hazardous Material Identification System; RCRA = Resource Conservation and Recovery Act; CERCLA = Comprehensive Environmental Response, Compensation and Liability Act; SARA = Superfund Amendments and Reauthorization Act; DSL = Canadian Domestic Substance List; EINECS = European Inventory of New and Existing Chemical Substances; WHMIS = Workplace Hazardous Materials Information System; CAA = Clean Air Act; CHPA=Canadian Hazardous Product Act; IDL=Canadian Hazardous Disclosure List

Revision Summary:

This is a revised MSDS which replaces Revision 1.0.2 with new formatting and updated exposure information. A new ID number was assigned to this document to be consistent with other IIG documents.

Get this and other MSDS forms electronically via Internet: <http://www.iig-llc.com>.

As of the date of preparation of this document, the foregoing information is believed to be accurate and is provided in good faith to comply with applicable federal and state law(s). However, no warranty or representation with respect to such information is intended or given.

IMPORTANT SAFETY NOTICE: The information in this MSDS relates only to the specific material described herein and does not relate to use in combination with any other material or substance or in any process. Because of the use of this information and the conditions of use of this product are not within the control of Industrial Insulation Group, it is the users obligation to determine the conditions of safe use of this product. Users of this product should study this MSDS and become aware of the product hazards and safety information before using this product. Users should also notify their employees, agents, and contractors regarding information contained in this MSDS and any product hazards and safety information in order to provide for safe use of this product.

Material Safety Data Sheet

SILICA, AS, CAS, AS/AR, CAS/AR, ASM and AST SERIES

1. CHEMICAL PRODUCT AND COMPANY IDENTIFICATION

Trade Names/Synonyms	Amorphous silica in various forms - cloth, tapes, blankets, mat, tubing, etc.
Product Identification	AS, CAS, AS/AR, CAS/AR, ASM and AST series.
Chemical Name/Synonyms	Continuous filament silicon dioxide (SiO ₂)/fibrous silica, amorphous silica chemical family.
Manufacturer's Name	DAR Industrial Products Inc 2 Union Hill Road Bldg # 1 West Conshohocken, Pa. 19428 (610) 825-4900
Date prepared	February 17, 1994
Revised	November 7, 1996 (second revision) November 4, 1997 (third revision: update Section 7, Handling based on IARC reclassification)
Reviewed for content & accuracy	April 16, 2007

2. COMPOSITION / INFORMATION ON INGREDIENTS

<u>Hazardous Ingredients</u>	<u>Weight %</u>	<u>OSHA-PEL</u>	<u>ACGIH-TLV</u>	<u>OTHER</u>
Silicone dioxide, continuous filament	≥ 90	a.	10 mg/ m ³ , 8-hr TWA	none known

Nonhazardous Ingredients

Sizing/bound water	≤ 10	----- none established -----		
--------------------	------	------------------------------	--	--

a. OSHA has not established a specific PEL for fibrous silicone dioxide (amorphous silica). It is considered to be a "particulate not otherwise regulated" (PNOR) and is covered under the OSHA nuisance dust PEL's of 5 mg/m³ for the respirable dust fraction and 15 mg/m³ for the total dust fraction for an 8-hr TWA (Time Weighted Average). Chemically, AMI-SIL[®] is amorphous silica which has an OSHA limit of 20 mppcf or 80 mg/m³.

3. HAZARDS IDENTIFICATION

PRIMARY ROUTES OF EXPOSURE: Inhalation and skin contact.

HEALTH HAZARDS (Including acute and chronic effects and symptoms of overexposure):

Material Safety Data Sheet

SILICA, AS, CAS, AS/AR, CAS/AR, ASM and AST SERIES

3. HAZARDS IDENTIFICATION (CONT)

- ACUTE:**
- Inhalation:** Inhalation of dusts and fibers may result in irritation of the upper respiratory tract (mouth, nose and throat).
 - Skin Contact:** Skin contact with dusts and fibers may produce itching and temporary mechanical irritation.
 - Eye Contact:** Eye contact with fibers and dusts may produce temporary mechanical irritation.
 - Ingestion:** Temporary mechanical irritation of the digestive tract. Observe individual. If symptoms develop, consult a physician.
- CHRONIC:** See carcinogenicity section below. There are no known health effects associated with chronic exposure to this product.

CARCINOGENICITY:

Hazardous Ingredients:	Listed as carcinogen by:	<u>ACGIH</u>	<u>IARC</u>	<u>NTP</u>	<u>OSHA</u>
Silicone dioxide, continuous filament		NA	NA	NA	NA

MEDICAL CONDITIONS AGGRAVATED BY EXPOSURE: Persons with a history of chronic respiratory or skin conditions that are aggravated by mechanical irritants may be at increased risk for worsening their condition from exposure during use of the product.

4. FIRST AID MEASURES

- Inhalation:** Move individual to fresh air. Seek medical attention if irritation persists.
- Skin Contact:** Wash with mild soap and running water. Use a washcloth to help remove fibers. To avoid further irritation do not rub or scratch irritated areas. Rubbing or scratching may force fibers into the skin. Seek medical attention if irritation persists.
- Eye Contact:** Flush eyes with flowing water for at least 15 minutes. Seek medical attention if irritation persists.
- Ingestion:** N. A. (Not Applicable)

Material Safety Data Sheet

SILICA, AS, CAS, AS/AR, CAS/AR, ASM and AST SERIES

5. FIRE FIGHTING MEASURES

Flash Point (°F): NA (Not Applicable)

Auto Ignition Temperature (°F): NA

Flammability Limits (%): LEL: NA UEL: NA

Extinguishing Media: Water, foam, carbon dioxide, dry chemical

Special Fire-Fighting Instructions: In a sustained fire, self contained breathing apparatus should be worn.

Unusual Fire and Explosion Hazards: None known.

6. ACCIDENTAL RELEASE MEASURES

ACTION TO TAKE FOR SPILLS (Use Appropriate Safety Equipment): For solid product, not applicable. For dusts and fibers generated during fabrication vacuum up and containerize.

7. HANDLING, STORAGE AND DISPOSAL

HANDLING: See Section 8.

The toxicologic data indicate that these materials should be handled with caution. The handling practices described in Section 8 of this MSDS must be strictly followed.

Product which has been in service at elevated temperature (> 1800° F) may undergo partial conversion to cristobalite, a form of crystalline silica. This reaction occurs at the lining hot face. As a consequence, this material becomes more friable (brittle); special caution must be taken to minimize generation of airborne dust. The amount of cristobalite present will depend on the temperature and length in service.

IARC has recently reviewed the animal, human and other relevant experimental data on silica in order to critically evaluate and classify the cancer causing potential. Based on its review, IARC has now classified crystalline silica/cristobalite as a Group 1 carcinogen. Crystalline silica inhaled in the form of quartz or cristobalite from industrial sources was classified as *carcinogenic to humans* on the basis of a relatively large number of epidemiological studies that together provided *sufficient evidence* in humans for the carcinogenicity of inhaled crystalline silica under the conditions specified. Crystalline silica is also listed by the NTP as a substance reasonably anticipated to be a carcinogen.

Material Safety Data Sheet

SILICA, AS, CAS, AS/AR, CAS/AR, ASM and AST SERIES

7. HANDLING, STORAGE AND DISPOSAL (CONT)

HANDLING (CON'T): See Section 8.

Therefore, special care should be taken when working with "used" material to minimize the generation of dust. The OSHA permissible exposure limit (PEL) for cristobalite is 0.05 mg/m^3 (resp.). The ACGIH threshold limit value (TLV) for cristobalite is 0.05 mg/m^3 (resp.). (ACGIH 1989 - 90). If exposure limits are exceeded or if irritation is experienced, NIOSH approved respiratory protection should be worn. NIOSH approved respirator for particulates with a TLV of less than 0.05 mg/m^3 is generally acceptable, except that supplied air respirators are required for high airborne dust concentrations.

STORAGE: Store in a clean, dry area. Keep containers closed.

DISPOSAL: Dispose in accordance with federal, state and local regulations as a solid nonhazardous waste.

8. EXPOSURE CONTROLS / PERSONAL PROTECTION

VENTILATION: General dilution ventilation and/or local exhaust ventilation should be provided, as necessary, to maintain exposures below PEL's or TLV's. Adequate ventilation must be provided at elevated temperatures. The base silica material is noncombustible; however, at temperatures above 250°F , the coating may generate light steam and/or smoke for a brief period which may require local ventilation some and/or exhaust.

RESPIRATORY PROTECTION: A properly fitted NIOSH/MHSA approved disposable dust respirator such as the 3M model 8710 or model 9900 (in high humidity environments) or equivalent should be used when: high dust levels are encountered; the level of fibers in the air exceeds the OSHA permissible exposure limits; or if irritation occurs. Use respiratory protection in accordance with your company's respiratory protection program and OSHA regulations under 29 CFR 1910.134.

EYE PROTECTION: Wear safety glasses or chemical goggles to prevent eye contact. Contact lenses should not be worn unless chemical goggles are also used and care is taken not to touch the eyes with contaminated body parts or materials. Have eye washing facilities readily available where eye contact can occur.

PROTECTIVE CLOTHING: Wear loose fitting, long sleeved shirt that covers to the base of the neck, and long pants. Skin irritation from exposure to silica fibers is known to occur chiefly at pressure points such as around the neck, wrist and waist. Wear gloves when handling product.

Material Safety Data Sheet

SILICA, AS, CAS, AS/AR, CAS/AR, ASM and AST SERIES

8. EXPOSURE CONTROLS / PERSONAL PROTECTION (CONT)

WORK/HYGIENIC PRACTICES: Handle in accordance with good industrial hygiene and safety practices:

- Avoid unnecessary exposure to dusts and fibers
- Remove fibers from skin after exposure
- Be careful not to rub or scratch irritated areas. Rubbing or scratching may force the fibers into the skin. The fibers should be washed off. Use of barrier creams can, in some instances, be helpful.
- Use vacuum equipment to remove fibers and dusts from clothing. **COMPRESSED AIR SHOULD NEVER BE USED.** Always wash work clothes separately and wipe out the washer/sink in order to prevent loose fibers from getting on other clothes.
- Keep the work area clean of any dusts and fibers generated during fabrication. Use vacuum equipment to clean up dusts and fibers. Avoid sweeping or using compressed air as these techniques resuspend dusts and fibers into the air.
- Have access to safety showers and eye wash fountains.
- For professional use only. **Keep out of children's reach.**

9. PHYSICAL AND CHEMICAL PROPERTIES

MELTING POINT (Softening): >3000°F : BOILING POINT (°C): NA (Not Applicable)

SPECIFIC GRAVITY: 2.2

PERCENT VOLATILE: NA

VAPOR PRESSURE (mm Hg): NA

VAPOR DENSITY (Air = 1): NA

EVAPORATIVE RATE (Ethyl Ether = 1): NA

SOLUBILITY IN WATER: Not soluble

APPEARANCE AND ODOR: White/off-white/tan colored solid with no odor; AR series has an orange color.

pH: NA

Material Safety Data Sheet

WIRE MESH, IWM Series1. CHEMICAL PRODUCT AND COMPANY IDENTIFICATION

Trade Names/Synonyms	Inconel Mesh Cable
Product Identification	Inconel Mesh Cable
Chemical Name/Synonyms	Inconel alloy.
Manufacturer's Name	D.A.R. Industrial Products Inc. 2 Union Hill Road, Bldg # 1 West Conshohocken, Pa. 19428
Date prepared	October 19, 1998
Reviewed for accuracy & content	<u>April 2, 2007</u>

2. COMPOSITION / INFORMATION ON INGREDIENTS

<u>Hazardous Ingredients</u>	<u>Weight %</u>	<u>OSHA-PEL</u>	<u>ACGIH-TLV</u>	<u>OTHER</u>
Iron (Fe) (as oxide fume)	proprietary	10 mg/m ³	5 mg/m ³	-----
Chromium (Cr)	proprietary	1 mg/m ³	0.5 mg/m ³	-----
Nickel (Ni)	proprietary	1 mg/m ³	1 mg/m ³	-----
Cobalt (Co)	proprietary	0.1 mg/m ³	0.1 mg/m ³	-----
Aluminum (Al)	proprietary	none	10 mg/m ³	-----
Manganese (Mn) Dust	proprietary	5 mg/m ³ C*	5 mg/m ³ C*	-----
Fume		3 mg/m ³	-----	-----
Molybdenum (Mo)	proprietary	15 mg/m ³	10 mg/m ³	-----
Tantalum (Ta)	proprietary	5 mg/m ³	5 mg/m ³	-----
Tungsten (W)	proprietary	none	5 mg/m ³	-----
Yttrium (Y)	proprietary	1 mg/m ³	1 mg/m ³	-----
<u>Nonhazardous Ingredients</u>	<u>Weight %</u>	<u>OSHA-PEL</u>	<u>ACGIH-TLV</u>	<u>OTHER</u>
Niobium (Nb)	proprietary	-----	-----none-----	-----
Iron (Fe) Dust	proprietary	-----	-----none-----	-----

C* = Ceiling Limit

Material Safety Data Sheet

AMI-FAB® WIRE MESH, IWM Series

3. HAZARDS IDENTIFICATION

PRIMARY ROUTES OF EXPOSURE: Inhalation and skin contact of dusts and fumes.

HEALTH HAZARDS (Including acute and chronic effects and symptoms of overexposure):

ACUTE: NOTE: Inconel products in their usual physical state do not pose any health hazards. However, when subjected to welding, burning, grinding, cutting, abrasive blasting, heat treatment, pickling, or similar operations, potentially hazardous fumes or dusts may be emitted. Despite the fact that welding, burning, etc. of inconel products in this category may produce fumes containing manganese, chromium, nickel and copper, the air concentrations generated of these components are expected to be extremely low.

Iron (Fe): Subjecting iron and alloys containing iron to high temperatures (such as welding) will cause the formation of iron oxide. Long-term exposure to iron oxide fumes or dusts has been associated with a benign lung condition known as siderosis which is observable as an x-ray change. No physical impairment of lung function has been linked to siderosis.

Manganese (Mn): Mn intoxication is usually due to the oxide or salts of Mn; elemental Mn exhibits very low toxicity. The dusts and fumes can act as minor irritants to the eyes and respiratory tract. Both acute and chronic exposure may adversely affect the central nervous system (CNS), but symptoms are more likely to occur after at least one or two years of prolonged or repeated exposures. Early symptoms may include weakness in the lower extremities, sleepiness, salivation, nervousness and apathy. In more advanced stages, severe muscular incoordination, impaired speech, spastic walking, mask-like facial expressions and uncontrollable coughing may occur. Manganese fumes have also been reported to result in metal fume fever, a flu-like syndrome with symptoms such as dizziness, chills, fever, headache and nausea. An increased incidence of pneumonia, bronchitis and pneumonitis has been reported in some worker populations exposed to manganese. Animal studies indicate exposure may increase susceptibility to bacterial and viral infection.

Chromium (Cr): The toxicity and health hazards of chromium are heavily dependent on its oxidation state. The elemental (as in the metals), divalent and trivalent forms are of very low toxicity. The hexavalent form (such as occurs in chromates and chromic acids) is very toxic and can produce both acute and chronic effects. Adverse effects on the skin may include ulcerations, irritative dermatitis and allergic skin reactions. Adverse effects on the respiratory system may include bronchospasms, edema, hypersecretion, bronchitis, irritation, allergic asthmatic reactions, and ulceration and perforation of the nasal septum. Respiratory symptoms may include coughing and wheezing, shortness of breath and nasal itch. Eye irritation or inflammation can also be produced. Exposure to some hexavalent chromium compounds have also been shown to be associated with an increased risk of lung cancer.

Nickel (Ni): Ni fumes and dust are respiratory irritants and may cause severe pneumonitis. Skin contact with nickel and its compounds may cause an allergic dermatitis. The resulting skin rash is often referred to as "nickel itch". Ni and its compounds may also produce eye irritation, particularly on the inner surfaces of the eyelids (i.e. the conjunctiva). Animal and/or epidemiology studies have linked nickel and certain nickel compounds to an increased incidence of cancer of the lungs and nasal passages.

Material Safety Data Sheet

AMI-FAB® WIRE MESH, IWM Series

3. HAZARDS IDENTIFICATION (CONT'D)

Copper (Cu): Inhalation of copper fume may cause irritation of the eyes and throat and a flu-like illness called metal fume fever. Signs and symptoms of metal fume fever include fever, muscle aches, nausea, chills, dry throat, cough and weakness. Cu fume may also produce a metallic or sweet taste. Repeated or prolonged exposure to Cu fume may cause discoloration of the skin or hair.

Aluminum (Al): There are no reported known health effects. Aluminum is generally considered to be in the nuisance dust category.

Silicon (Si): Silicon may produce x-ray changes in the lungs. There has been no known disability reported from the x-ray changes.

Tungsten (W): There has been some reported evidence of pulmonary involvement such as a cough.

Molybdenum (Mo): Molybdenum has caused, in animal studies, irritation of the nose and throat, weight loss and digestive disturbances. There have been no reports of industrial poisoning.

Cobalt (Co): Cobalt has been reported to cause asthma. It may also cause interstitial pneumonitis and sensitization of the respiratory system.

ACUTE: **Inhalation:** Inhalation of dusts and fibers may result in irritation of the upper respiratory tract (mouth, nose and throat).

Inconel - dust or fumes may give a metallic taste; headache; nausea; chills; fever; tightness of chest; irritation of the respiratory tract, eyes, nose; cough.

Loss of consciousness/death due to welding gases or lack of oxygen.

Skin Contact: Skin contact with dusts and fibers may produce itching and temporary mechanical irritation.

Eye Contact: Eye contact with fibers and dusts may produce temporary mechanical irritation.

Ingestion: Temporary mechanical irritation of the digestive tract. Observe individual. If symptoms develop, consult a physician.

CHRONIC: See carcinogenicity section below. Chronic exposure to Chromium (Cr)/Nickel (Ni)/Manganese (Mn) fumes or dust may cause skin sensitization, asthma, bronchitis, lung fibrosis or pneumoniosis. It may also cause damage to the kidneys and liver as well as the nervous system.

Material Safety Data Sheet

AMI-FAB® WIRE MESH, IWM Series

3. HAZARDS IDENTIFICATION (CONT'D)

CARCINOGENICITY:

Hazardous Ingredients: Listed as carcinogen by: ACGIH IARC NTP OSHA

Chromium (Cr)/Nickel (Ni)** ----none known----

****Dusts and fumes containing Chromium (Cr) or Nickel (Ni) should be considered carcinogens.**

MEDICAL CONDITIONS AGGRAVATED BY EXPOSURE: Persons with a history of chronic respiratory or skin conditions that are aggravated by mechanical irritants may be at increased risk for worsening their condition from exposure during use of the product.

4. FIRST AID MEASURES

Inhalation: Move individual to fresh air. Seek medical attention if irritation persists. Administer artificial respiration, if breathing has stopped.

Skin Contact: Wash with mild soap and running water. To avoid further irritation do not rub or scratch irritated areas. Seek medical attention if irritation persists.

Eye Contact: Flush eyes with flowing water for at least 15 minutes. Seek medical attention if irritation persists.

Ingestion: N. A. (Not Applicable)

5. FIRE FIGHTING MEASURES

Flash Point (°F): NA (Not Applicable)

Auto Ignition Temperature (°F): NA

Flammability Limits (%): LEL: NA UEL: NA

Extinguishing Media: Water, foam, carbon dioxide, dry chemical

Special Fire-Fighting Instructions: In a sustained fire, self contained breathing apparatus should be worn.

Unusual Fire and Explosion Hazards: None known.

6. ACCIDENTAL RELEASE MEASURES

ACTION TO TAKE FOR SPILLS (Use Appropriate Safety Equipment): For solid product, not applicable. For dusts and fibers generated during fabrication vacuum up and containerize.

Material Safety Data Sheet

AMI-FAB® WIRE MESH, IWM Series

7. HANDLING, STORAGE AND DISPOSAL

HANDLING: See Section 8.

STORAGE: No special precautions necessary.

DISPOSAL: Dispose in accordance with federal, state and local regulations as a solid nonhazardous waste.

8. EXPOSURE CONTROLS / PERSONAL PROTECTION

VENTILATION: General dilution ventilation and/or local exhaust ventilation should be provided, as necessary, to maintain exposures below PEL's or TLV's. Adequate ventilation must be provided at elevated temperatures. Adequate ventilation must also be provided when welding or grinding the inconel core.

RESPIRATORY PROTECTION: A properly fitted NIOSH/MHSA approved disposable dust respirator should be used when: high dust levels are encountered; the level of Chromium/Nickel/Manganese/Cobalt/Aluminum/Molybdenum/Tantalum/Tungsten/Yttrium dust in the air exceeds the OSHA permissible exposure limits; or if irritation occurs. Use an air supplied respirator in confined spaces. Use industrial hygiene air monitoring to insure that TLV or PEL values are not exceeded. Use respiratory protection in accordance with your company's respiratory protection program and OSHA regulations under 29 CFR 1910.134 .

EYE PROTECTION: Safety glasses, goggles or face shields should be worn.

PROTECTIVE CLOTHING: Wear loose fitting, long sleeved shirt that covers to the base of the neck, and long pants. Wear gloves when handling product.

WORK/HYGIENIC PRACTICES: Handle in accordance with good industrial hygiene and safety practices:

- = Avoid unnecessary exposure to dusts.
- = Do not expose skin when cutting, grinding or welding the inconel mesh cable.
- = Be careful not to rub or scratch irritated areas. Use of barrier creams can, in some instances, be helpful.
- = Use vacuum equipment to remove dusts from clothing. **COMPRESSED AIR SHOULD NEVER BE USED.** Always wash work clothes separately.
- = Keep the work area clean of any dusts generated during fabrication. Use vacuum equipment to clean up dusts. Avoid sweeping or using compressed air as these techniques resuspend dusts into the air.
- = Have access to safety showers and eye wash fountains.
- = For professional use only. **Keep out of children's reach.**

Material Safety Data Sheet

AMI-FAB® WIRE MESH, IWM Series

9. PHYSICAL AND CHEMICAL PROPERTIES

MELTING POINT (Softening): NM (Not Measured)

BOILING POINT (°C): NA (Not Applicable)

SPECIFIC GRAVITY (Bare Glass): NM

PERCENT VOLATILE: NA

VAPOR PRESSURE (mm Hg): NA

VAPOR DENSITY (Air = 1): NA

EVAPORATIVE RATE (Ethyl Ether = 1): NA SOLUBILITY IN WATER: Not soluble

APPEARANCE AND ODOR: Metallic appearing mesh with no odor.

pH: NA

10. STABILITY AND REACTIVITY

STABILITY (Conditions to Avoid): Product is stable.

INCOMPATIBILITY (Materials to Avoid): None known.

HAZARDOUS DECOMPOSITION PRODUCTS: SEE SECTION 3.

HAZARDOUS POLYMERIZATION: Will not occur.

To the best of our knowledge, the information contained herein is accurate. The information provided is based upon data furnished by our suppliers. However, neither [redacted], nor any of its subsidiaries assumes any liability whatsoever for the accuracy or completeness of the information contained herein. While believed to be reliable, the information or products are intended for use by skilled persons at their own risk. Final determination of suitability of any material is the sole responsibility of the user. All materials may present unknown hazards and should be used with caution. Although certain hazards are described herein, we cannot guarantee that these are the only hazards which exist.



Date: 8/31/2005
 MSDS ID: 20501
 Rev: 1.0.4
 Replaces: 10/6/2003

Material Safety Data Sheet

Material Name: Calcium Silicate Insulation

Section 1— Chemical Product and Company Identification

Product Name: Thermo-12[®] Gold Calcium Silicate Insulation
CAS# Mixture/None Assigned
Generic Name: Insulation (Calcium Silicate)
Formula: Mixture
Chemical Name: Synthetic Calcium Silicate

Manufacturer Information

Industrial Insulation Group
 2100 Line Street
 Brunswick, GA. 31520

Phone number for Health and Safety Information: 970.858.6211 (M-F, 7:00a.m. to 4:00p.m., Mountain Time)

Trade Name: Thermo-12 Gold

Section 2 — Composition and Information on Ingredients

CAS #	Component	Percent	OSHA	ACGIH	NIOSH	UNITS
			PEL	TLV	REL	
1344-95-2	Synthetic Calcium Silicate	> 93	15(T) 5(R)	10	10(T) 5(R)	mg/M ³
51274-00-1	Iron-based color	< 1	15(T) 5(R)	10	NE	mg/M ³
65997-17-3	Synthetic Vitreous Fiber	0 - 2	15(T) 5(R)	5	5	mg/M ³
9004-34-6	Cellulose Fiber	0 - 2	15(T) 5(R)	10	10(T) 5(R)	mg/M ³
1344-09-8	Sodium Silicate	0 - 6	15(T) 5(R)	10	NE	mg/M ³

NE = Not Established

ACGIH TLVs are 2003 values. OSHA PELs are those in effect on the date of preparation of this MSDS. The listed PELs, TVLs and RELs are time weighted average exposure limits.

Component Related Regulatory Information

This product may be regulated, have exposure limits or other information identified as the following:
 Nuisance particulates.

Section 3 — Hazards Identification

Emergency Overview

APPEARANCE AND ODOR: Odorless, Yellow semi-circle or block insulation with coloring throughout as a visual marker to indicate this is an asbestos-free product.

This product is an article and under normal conditions of use, this product is not expected to create any unusual emergency hazards. However, cutting, sawing, or abrading may increase the risk of personnel exposure.

Inhalation of excessive amounts of dust created when fabricating, cutting, or other mechanical alterations of the product may cause temporary upper respiratory irritation and/or congestion— remove affected individuals to fresh air.

Skin irritation may be treated by gently washing affected area with soap and warm water.

Eye irritation may be treated by flushing eyes with large amounts of water. If irritation persists, contact a physician.

Prolonged contact with dust from this product may cause Dermatitis.

In the event of fire, use normal fire fighting procedures to prevent inhalation of smoke and gases.

HMIS Rating: Health: 1, Fire: 0, Reactivity 0, Other: 0
WHMIS Class: Thermo-12 Gold is not a WHMIS controlled product

Potential Health Effects

Summary

Breathing dust from this product may cause a scratchy throat, congestion, and slight coughing.

Getting dust or fibers on the skin, or in the eyes may cause itching, rash, or redness.

Breathing large amounts of dust or fibers from this product may lead to chronic health effects as discussed in Section 11 of this material safety data sheet.

Inhalation

Irritation of the upper respiratory tract (scratchy throat), coughing, and congestion may occur in extreme exposures.

Skin

Temporary irritation (itching) or redness may occur.

Absorption

Not applicable

Ingestion

This product is not intended to be ingested or eaten under normal conditions of use. If ingested, it may cause temporary irritation to the gastrointestinal (GI) tract, especially the stomach.

Eyes

Temporary irritation (itching) or redness may occur.

Target Organs

Upper respiratory passages, skin, and eyes.

Primary Routes of Entry (Exposure)

Inhalation (breathing dust), skin, and eye contact.

Medical Conditions Aggravated by Exposure

Pre-existing chronic respiratory, skin, or eye diseases or conditions may be aggravated by exposure to this product

Section 4 — First Aid Measures

First Aid: Inhalation

Remove to fresh air. Drink water to clear throat, and blow nose to remove dust.

First Aid: Skin

Wash gently with soap and warm water to remove dust. Wash hands before eating or using the restroom.

First Aid: Ingestion

Product is not intended to be ingested or eaten. If this product is ingested, irritation of the gastrointestinal (GI) tract may occur, and should be treated symptomatically. Rinse mouth with water to remove fibers, and drink plenty of water to help reduce the irritation. No chronic effects are expected following ingestion.

First Aid: Eyes

Do not rub or scratch your eyes. Dust particles may cause the eye to be scratched. Flush eyes with large amounts of water for 5-15 minutes. If irritation persists, contact a medical professional.

First Aid: Notes to Physician

This product is a mechanical irritant, and is not expected to produce any chronic health effects from acute exposures. Treatment should be directed toward removing the source of irritation with symptomatic treatment as necessary.

Section 5 — Fire Fighting Measures

Flash Point: Not applicable
Upper Flammable Limit (UFL): Not applicable
Auto Ignition: Not determined
Rate of Burning: Not applicable

Method Used: Not applicable
Lower Flammable Limit (LFL): Not applicable
Flammability Classification: Non combustible

General Fire Hazard

There is no potential for fire or explosion.

Extinguishing Media

Use any extinguishing media appropriate for the surrounding fires

Fire Fighting Equipment/Instructions

No special procedures are expected to be necessary for this product. Normal fire fighting procedures should be followed to avoid inhalation of smoke and gases produced by other materials.

Section 6 — Accidental Release Measures

Containment Procedures

Pick up large pieces. Vacuum dusts. If sweeping is necessary, use a dust suppressant such as water. Do not dry sweep dust accumulation or use compressed air for clean-up. These procedures will help to minimize potential exposures.

Clean-Up Procedures

Wastes are not hazardous as defined by the RCRA (40 CFR 261). Comply with state and local regulations for disposal of these products. If you are unsure of the regulations, contact your local Public Health Department, or the local office of the Environmental Protection Agency (EPA).

Section 7 — Handling and Storage

Handling Procedures

Use protective equipment as described in Section 8 of this material safety data sheet when handling uncontained material. Good housekeeping practices should be used to prevent generation and accumulation of dusts. After handling product, wash face and hands before eating, drinking, or smoking.

Storage Procedures

Warehouse storage should be in accordance with package directions, if any. Material should be kept dry, and protected from the elements.

Section 8 — Exposure Control and Personal Protection

General Product Information

This product may contain trace amounts of crystalline silica as a natural contaminant in the raw materials. However, standard industrial hygiene air monitoring surveys conducted under normal and test (worst-case) situations have not detected any airborne respirable crystalline silica in the occupational environment.

Personal Protective Equipment

Personal Protective Equipment: Eyes/Face

Safety glasses with side shields are recommended to keep product out of the eyes.

Personal Protective Equipment: Skin

Leather or cotton gloves should be worn to prevent skin contact and irritation. Barrier creams may also be used to reduce skin contact and irritation caused by fiber glass.

Personal Protective Equipment: Respiratory

A respirator should be used if ventilation is unavailable, or is inadequate for keeping dust and fiber levels below the applicable exposure limits. In those cases, use a NIOSH-certified disposable or reusable particulate respirator with an efficiency rating of N95 or higher (under 42 CFR 84) when working with this product. For exposures up to five times the established exposure limits use a quarter-mask respirator, rated N95 or higher; and for exposures up to ten times the established exposure limits use a half-mask respirator (e.g., MSA's DM-11, Racal's Delta N95, 3M's 8210), rated N95 or higher.

Operations such as sawing, blowing, tear out, and spraying may generate airborne fiber concentrations requiring a higher level of respiratory protection. For exposures up to 50 times the established exposure limits use a full-face respirator, rated N99 or higher.

Ventilation

In fixed manufacturing settings, local exhaust ventilation should be provided at areas of cutting to remove airborne dust and fibers. General dilution ventilation should be provided as necessary to keep airborne dust and fibers below the applicable exposure limits and guidelines. The need for ventilation systems should be evaluated by a professional industrial hygienist, while the design of specific ventilation systems should be conducted by a professional engineer.

Personal Protective Equipment: General

Loose-fitting, long-sleeved clothing should be worn to protect the skin from irritation. Exposed skin areas should be washed with soap and warm water after handling.

Section 9 — Physical & Chemical Properties

Appearance: Semi-circle or block insulation with yellow coloring throughout as a visual marker to indicate this is an asbestos free product.

Odor:	Odorless	pH:	Not applicable
Physical State:	Solid	Vapor Density:	Not applicable
Vapor Pressure:	Not applicable	Melting Point:	1200-1500°C
Boiling Point:	Not applicable	Specific Gravity:	0.24-0.27
Solubility (H2O):	Nil	Freezing Point:	Not applicable
Viscosity:	Not applicable	Evaporation Rate:	Not applicable
VOC:	Not applicable	Percent Volatile:	0

Section 10 — Chemical Stability & Reactivity Information

Chemical Stability

This is a stable material. This product is not reactive.

Hazardous Decomposition

None.

Hazardous Polymerization

Will not occur.

Section 11 — Toxicological Information

Acute Toxicity

A: General Product Information

The primary acute health effects of this product include mechanical irritation of the skin and eyes and skin dryness as a result of contact with dust, amorphous silica, and fibers.

B: Component Analysis - LD50/LC50

No LD50/LC50's are available for this product or its components.

Carcinogenicity

A: General Product Information

OSHA, NTP, IARC, and ACGIH have not classified this product in its entirety as a carcinogen.

B: Component Carcinogenicity

Calcium silicate (1344-95-2)

ACGIH: A4 - Not Classifiable as a Human Carcinogen

Synthetic Vitreous Fiber (65997-17-3)

ACGIH: A4 - Not Classifiable as a Human Carcinogen (related to rock wool fiber)

IARC: Monograph 43, 1988 (related to Glass filaments) (Group 3 (not classifiable))

Section 12 — Ecological Information

Ecotoxicity

A: General Product Information

No data available for this product.

B: Component Analysis - Ecotoxicity - Aquatic Toxicity

No ecotoxicity data are available for this product's components.

Section 13 — Disposal Considerations

US EPA Waste Number & Descriptions

A: General Product Information

This product, as supplied, is not regulated as a hazardous waste by the U.S. Environmental Protection Agency (EPA) under Resource Conservation and Recovery Act (RCRA) regulations. Comply with state and local regulations for disposal. If you are unsure of the regulations, contact your local Public Health Department, or the local office of the EPA.

B: Component Waste Numbers

No EPA Waste Numbers are applicable for this product's components.

Disposal Instructions

Dispose of waste material according to Local, State, Federal, and Provincial Environmental Regulations.

Section 14 — Transport Information

US DOT Information

Shipping Name: This product is not classified a hazardous material for transport.

Section 15 — Regulatory Information

US Federal Regulations

A: General Product Information

No information on this product as a whole.

B: Component Analysis

None of this product's components are listed under SARA Section 302 (40 CFR 355 Appendix A), SARA Section 313 (40 CFR 372.65), or CERCLA (40 CFR 302.4).

State Regulations

A: General Product Information

No information available for the product.

Other Regulatory Information

A: General Product Information

No information available for the product.

B: TSCA Status

No information available for the product.

International Regulations

Canada Workplace Hazardous Materials Information System (WHMIS)

WHMIS Classification: D2B– Irritant

Product classified as a manufactured article as defined in HPA, Section 11(1). Section 12(l) exempts it from the WHMIS supplier label and MSDS requirements of the Act.

Component Analysis - WHMIS IDL

The following components are identified under the CHPA IDL:

Sodium Silicate—CAS 1344-09-8

Section 16 — Other Information

This product has been classified according to the hazard criteria of the CPR and the MSDS contains all the information required by the CPR.

Key/Legend:

EPA = Environmental Protection Agency; TSCA = Toxic Substance Control Act; ACGIH = American Conference of Governmental Industrial Hygienists; IARC = International Agency for Research on Cancer; NIOSH = National Institute for Occupational Safety and Health; NTP = National Toxicology Program; OSHA = Occupational Safety and Health Administration; NFPA = National Fire Protection Association; HMIS = Hazardous Material Identification System; CERCLA = Comprehensive Environmental Response, Compensation and Liability Act; SARA = Superfund Amendments and Reauthorization Act; DSL = Canadian Domestic Substance List; EINECS = European Inventory of New and Existing Chemical Substances; WHMIS = Workplace Hazardous Materials Information System; CAA = Clean Air Act; CHPA=Canadian Hazardous Product Act; IDL=Canadian Hazardous Disclosure List

Revision Summary:

This is a revised MSDS which replaces Revision 1.0.3 with new formatting and clarified exposure limits. Get this and other MSDS forms electronically via Internet: <http://www.iig-llc.com> or by calling 1-970-858-6200.

As of the date of preparation of this document, the foregoing information is believed to be accurate and is provided in good faith to comply with applicable federal and state law(s). However, no warranty or representation with respect to such information is intended or given.

IMPORTANT SAFETY NOTICE: The information in this MSDS relates only to the specific material described herein and does not relate to use in combination with any other material or substance or in any process.

Because of the use of this information and the conditions of use of this product are not within the control of Industrial Insulation Group, it is the users obligation to determine the conditions of safe use of this product. Users of this product should study this MSDS and become aware of the product hazards and safety information before using this product. Users should also notify their employees, agents, and contractors regarding information contained in this MSDS and any product hazards and safety information in order to provide for safe use of this product.

DURA-FIRE INSTRUCTION MANUAL



L&L Kiln's patented
hard ceramic
element holders
protect your kiln.

Features & Benefits of L&L Kilns

L&L Kilns are unique. It just starts with the easy maintainability of the kiln.

Dyna-Glow holders enhance uniformity

L&L kilns naturally fire evenly top to bottom. The whole Dyna-Glow ceramic element holder glows with radiant heat. (See hotkilns.com/zone-control.html for test data comparing an Easy-Fire e23T to a competitive model).

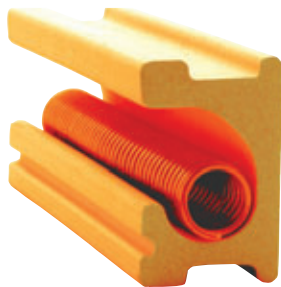

Dyna-Glow holders protect elements

Reliability, durability and element life are enhanced by Dyna-Glow element holders. The smooth, hard surface of the inside channel allows the elements to expand and contract freely - unrestricted by pins - preventing catastrophic element failure. Elements won't droop out of broken firebrick channels. Also the dense ceramic Dyna-Glow holders extend element life because they do not insulate the hot elements from the kiln interior.

Holder Prevents Rim Damage

Hard ceramic holders support the brick inside the element grooves, creating a strong structure and preventing damage to the rim.



Quick-change elements

With L&L's Dyna-Glow element holders in your kiln, changing elements takes minutes, not hours. You don't need to worry about breaking brick, installing clumsy pins, or crimping element connectors. Anyone can do it with a screwdriver and a wrench.



L&L kilns are easy to troubleshoot

Open up any L&L kiln control panel and see how easy it is to check amps, element resistance, and voltage. No other kiln can be serviced as quickly, easily, or inexpensively as an L&L kiln.

Sectional construction makes repair work easy

All top-loading L&L kilns are sectional. Even the large 35 cubic foot standard DaVinci kiln is easy to move, set up, and repair.

Protected thermocouples last longer

Our standard thermocouple is shielded from corrosion by a ceramic protection tube. We use the finest "special limit" aerospace-grade heavy-gauge thermocouple wire. The protection tube also prevents black dust from the thermocouple end from discoloring your work.



Maximum corrosion resistance

Stainless, aluminized, and galvanealed steel are used where needed. Hardware and screws are pure stainless steel.

Solid peephole plugs

Our solid straight plugs are strong. They do not slip out like tapered, fragile slip-cast plugs.

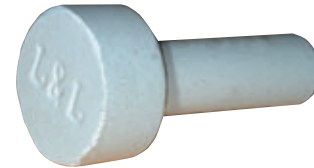

Lid brick is secured

Stainless "U" brackets secure the firebrick to the edge metal. The lid brick support does not rely on friction.



Full-support stands

L&L provides an engineered full-support 14 gauge (about 2 millimeters thick) aluminized steel stand. They are stronger than hollow frame stands and they provide important support in the center of the kiln bottom.

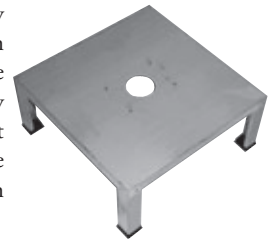

Proprietary Brick Coating

L&L's proprietary reflective brick coating protects the surface of the firebrick and keeps dusting down inside the kiln.



505 Sharptown Road • Swedesboro, NJ 08085
Phone: 856.294.0077 • Fax: 856.294.0070
Email: sales@hotkilns.com • Web: www.hotkilns.com



L&L Kiln's patented hard ceramic element holders protect your kiln.

Features & Benefits of L&L Kilns

Performance • Durability • Support • Serviceability • Safety

Our “Easy-Open, Easy-Load” lid is feather-lite yet opens wide for loading

The whole kiln supports the lid (not just one section). Our positive safety pin secures the lid so it can't accidentally fall while loading the kiln. No support bars get in the way of loading when the lid is fully tilted back.



normally vent two kilns with one vent using our optional vent doubler. Even if the vent duct leaks, fumes will get *pulled* into the duct, not *pushed* into your room. Our Vent-Sure motors keep on working because they are mounted away from the kiln heat and floor dust. Motor vibration is isolated from your work.

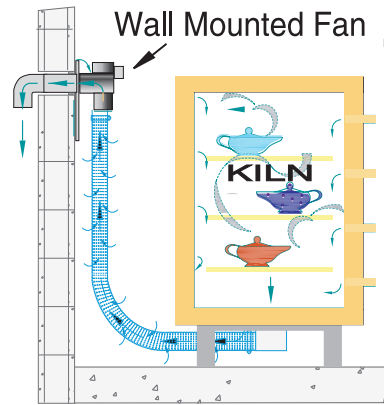

The DynaTrol is easy and powerful

Artists have four choices of Easy-Fire programs plus six of their own. The important Delay, Preheat, and Alarm options are organized into a One-Touch “Easy Options” section on the control face.



Zone control dynamically adjusts kiln

Zone control dynamically adjusts the kiln firing - maintaining evenness over time and with different loads. You can replace one element at a time without worrying about an imbalance.

Uniform even without zone control

Even on the School-Master kilns, where we do use graded elements, L&L kilns are so fundamentally uniform because of the element holders that the differential in the graded elements is much less than in competing kilns.

The One-Touch™ Control is designed for K-12 schools & hobbyists

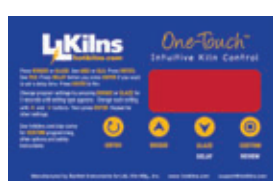

Proprietary One-Touch™ Intuitive Kiln Control is designed for busy school teachers - One touch and you are ready to

fire the bisque and glaze programs typically used in schools (also easy to adjust simple parameters like cone, delay, hold, heat-up and cool-down rates).

Vent-Sure is safe, strong and adaptable

Our powerful 148 CFM downdraft Vent-Sure adapts to long installation runs. In fact you can

Easy-to-use visual instructions

No one has a better or more complete instruction manual. Our visual instructions address the needs of the artist, the installer, and the repair person. You get a fully illustrated operation and service manual. Various instructional videos are available at www.youtube.com/LLKilns.

Web support for kilns

One customer recently said: “I am truly impressed with your web site, it is more than informative and your products are well designed. The fact that all the information, including repair manuals, are listed, speaks well of your dedication to customer service.”

Free 800 numbers for support

We respond quickly to your needs Monday through Friday.

Safe, fast delivery

L&L's flow manufacturing system allows us to ship built-to-order kilns quickly. Typical delivery for an Easy-Fire, School-Master kiln or Liberty-Belle kiln is about two weeks. Parts normally ship within 24 hours (often the same day). Our advanced packaging guarantees your kiln arrives in great shape.

Responsive engineering since 1945

We pride ourselves on flexibility, technical depth, and the ability to listen to customers. L&L makes more models, kiln configurations, and options than anyone. L&L kilns and custom furnaces are in continuous use by NASA, Fermi Lab, Kodak, 3M, Corning, General Motors, General Electric as well as countless art schools, universities, schools, and pottery studios worldwide. More and more people recognize the unique value of L&L kilns.

Each Kiln Series has its own special features

Each series of L&L kilns has its own special features and even, in some cases like the JH Series, its own applications. Read through the specification sheets and our product selection guides and price list to see what fits your exact needs. And don't forget - we and our fine distribution network are here to help you make the right choice. Call us!

Mercury-free

All L&L kilns use mercury-free relays.

On-off Switch

All L&L kilns include an industrial-grade on-off switch.

UL499 listing

Many L&L kilns, including Easy-Fire, Jupiter and DaVinci kilns, as well as our Vent-Sure vent, are c-MET-us listed to UL499 standards. Our Renaissance and Easy-Load Front-Loading kilns are MET-us listed to UL499 standards.

Support from experienced people

The staff at L&L has worked as a team for many years to ensure customer satisfaction. We support our distributors with extensive technical information so they can effectively support you.





KILNS BUILT TO LAST

L&L Kiln Mfg. Inc. ♦ 505 Sharptown Rd. ♦ Swedesboro, NJ 08085

Phone: 856.294.0077 ♦ Fax: 856.294.0070 ♦ Email: sales@hotkilns.com ♦ Web: hotkilns.com

FREQUENTLY ASKED QUESTIONS

SALES QUESTIONS

What is the difference between an Easy-Fire and a Jupiter kiln?

The Easy-Fire kilns were designed to meet the need for an uncomplicated easy-to-buy kiln that meets the majority of kiln users' needs. We selected four popular sizes and restricted the line to automatic only. There are virtually no options. On the other hand, we decided to use all of our best technology like element holders, thermocouple protection tubes, "Easy-Lift, Easy-Load" spring hinge, heavy-duty elements and zone control so, for the most part, there are no options you would likely want to add. We redesigned the control panel to remove the plug-in cords which some people find objectionable (yet others love). This results in a sleeker kiln that is more acceptable in many classrooms and studios. However, even with this new design we maintained the famous L&L tradition of an easy-to-service and easy-to-remove control panel that is isolated as much as possible from the heat of the kiln. We also took advantage of the simplicity of the design to increase the power of the kilns. Because there are so few models we could maximize the power on each voltage and phase without implication to other models. This is just too complicated to do on the Jupiter line. Long story short is that, if the size and configuration of the Easy-Fire models suits you go ahead and buy an Easy-Fire kiln. If you want a manual kiln or one of the many sizes of the Jupiter line or one of the many options available in that line then by all means get a Jupiter. You will find that feature for feature the Easy-Fire line is a better price and this is partly a direct result of the simplicity and uniformity of the line. One might compare the difference to a "prefix menu" vs. an "a la cart menu" – the choice is yours.

What is the difference between a Jupiter kiln and a DaVinci kiln?

The DaVinci kilns are normally larger and are square and rectangular in shape. For some the shape is critical (for tiles for instance) and makes the kiln for efficient in terms of usable space. For others the size is the issue. There are simple so other sectional kilns that are made this large. The counterbalanced lid system and angle-iron stand are very heavy-duty on the DaVinci kilns and make even the heaviest lid easy to lift. The control panels on most DaVinci kilns (except the X2327, X2336 and X2345 which use a Jupiter panel mounted on the kiln) are floor standing and feature 50 amp circuits. The DynaTrol on the DaVinci kilns (again except for the X2300 models mentioned) is a handheld model that attaches to the kiln with a four-foot cable and can hang on the wall or the panel. The DaVinci kilns use 3" brick. The share many of the same options like Dawson back-up for automatic kilns, bottom elements, etc.

Where can I buy L&L Kilns?

Call our factory to get the name of a local distributor. If there is not a local distributor near you or if you prefer to buy direct we can help you as well.

How Should I place an order if I order direct?

Call the factory or fax in an order. See hotkilns.com/direct.pdf for a list of important questions to ask yourself before ordering from the factory. We collect sales tax in Pennsylvania, New Jersey, Ohio, Texas, Illinois and several other states.

FREQUENTLY ASKED QUESTIONS

What payment do you accept?

Money order, check, wire transfer, Visa, MasterCard and American Express are accepted. Payment by wire transfer, money order or credit card will allow immediate processing of your order. Payment by personal check requires a three-week delay for check to clear. No COD's on kilns, (parts are OK). Purchase orders are accepted from schools and companies; however, credit must be preapproved. Companies must have a Dun & Bradstreet Paydex score of 65 or better. Call, fax or email for the instructions on how to wire transfer. Wire transfers are particularly helpful for export transactions.

Are kilns returnable?

Kilns are not returnable. Each kiln is configured to order. We try hard to make your choice easy by providing as much information as possible but we ask that you make a careful choice.

What if I order the wrong voltage or phase?

Changing the phase is easy on a Jupiter or DaVinci kiln because of the unique way in which we do our circuits. Changing the phase on an Easy-Fire kiln requires switching the control panel - which is very easy to do. Contact factory for details. Changing the voltage is not so easy. You need to change all the elements. While we do not accept responsibility for others mistakes we do our best to minimize the expense. Call the factory if this happens and we will sell you a set of appropriate elements at a deep discount.

Does L&L Export?

Orders for export will be shipped by ocean or air, freight collect. Mexico and Canada can ship by common carrier. Import and export licenses, duties, tariffs, etc. are expenses due from the purchaser. We can quote CIF shipping charges. See hotkilns.com/ship.pdf for more information.

How to get to the L&L factory and can I visit?

We are open from 8:30am - 5:00 pm Monday through Friday. Please call ahead for an appointment.

SHIPPING QUESTIONS

How much does it cost to ship a kiln?

Talk to your local distributor or call our factory for a shipping quote (if you are buying direct from the factory).

How are L&L kilns packed?

Easy-Fire, Jupiter, Liberty-Belle, Chameleon, Doll/Test and GS1714 kilns are protected with advanced foam-in-place in heavy-duty skidded cartons. DaVinci kilns typically come in two skidded wood crates or cartons. Renaissance and Easy-Load kilns are crated as well. Our free advanced packaging has virtually eliminated shipping damage. See page 30 of our main catalog. Export crating is by special quote but is normally not required if kilns ship by container (which is almost always the case for ocean freight). Airfreight does not need any special packing.

What is the freight classification?

Class 85.

What is the F.O.B. (Freight on Board) point?

All kilns are shipped from our factory in Swedesboro, NJ (10 miles south of Philadelphia PA).

What do I do if there is shipping damage?

See hotkilns.com/damage.pdf.

What freight companies does L&L use? Can I specify a freight company?

We use a variety of companies. We try to use only freight lines that we have had good experience with. You can specify a freight company if you have a preference. L&L will make all shipping arrangements with you prior to shipping. Tailgate loading is available for an extra charge of \$75. This is where the trucker will lower the kiln to

FREQUENTLY ASKED QUESTIONS

the ground with a special tailgate lift. If you buy from a local distributor they may offer delivery and set up. See hotkilns.com/ship.pdf.

How easy is the set up of L&L kilns?

Setting up any of our kilns is very simple. The sectional design of the Easy-Fire, Liberty-Belle, Jupiter and DaVinci kilns makes moving the kiln exceptionally easy - even down steps or through narrow doorways. The DaVinci counterbalance comes apart. Two people can carry the largest DaVinci section. Just locate and level the stand, stack the sections, plug in the control panel and have an electrician hook up power. If you bought a vent you will need to install the motor on an outside wall. Set-up instructions (with photographs) are attached to the outside of the carton and take you through the process step-by-step starting with unpacking. See hotkilns.com/pdf.htm for set-up instructions for all our kilns. Moving the Renaissance and Easy-Load kilns requires special handling (they can not be moved up stairs for instance). Talk to the factory before assuming you can do this.

Can L&L ship kilns Prepay and Add?

Yes.

Can L&L ship kilns collect?

No.

What are the packing charges for parts?

See hotkilns.com/ship.pdf for more information.

How does L&L ship parts?

We work with both UPS and Federal Express. Generally speaking Federal Express is a better deal for shipments west of the Mississippi. We can ship next day or second day if you request it. Saturday delivery is available in most places. We can ship by FedEx, UPS or DHL for overseas parts shipments.

TECHNICAL QUESTIONS

Are automatic controls reliable?

In years past electronic controls for kilns had some reliability problems. Today, we see very little of this. The DynaTrol has a long history of reliability. Its antecedents have been used on kilns for many years and many thousands of these antecedents are still in use today. L&L, in most cases, mounts its automatic control in an instrument box that is separate from the kiln. It is easy to remove and send to our factory for expert repair (if ever necessary).

Can I convert my older J Series Manual Econo-Kiln to an automatic kiln?

The new Jupiter automatic kilns use the same basic kiln sections that made the J Series Econo-Kilns so popular and reliable. You can purchase a new control box that the old sections will plug into. See hotkilns.com/jupiter-parts.pdf for pricing on the various panels. Because of the cost of a new panel, it may be worth considering buying a new kiln but, in any case, the option is a possibility. Be sure to talk directly to the factory if you want to do this. We are using all 20 amp cords and receptacles now and, on some J Series kilns, you may have to change either your plugs or have us put in 15 amp receptacles.

Does L&L make a wall mount control that I can plug my kiln into?

We used to but the need was so minimal that we have discontinued doing this. If you want to do this you can talk to Orton (ortonceramic.com).

Can I buy a manual kiln now and convert it to an automatic kiln later.

You can but it would not be cost effective. See above comments.

FREQUENTLY ASKED QUESTIONS

What can I do to promote even kiln firings?

Our DynaTrol automatic control with Dynamic Zone Control is the state of the art way to do this. On manual kilns we recommend you use our Truview Pyrometer System. In addition, the way you load the kiln will help promote good uniform firings. You must keep enough space in the kiln to allow air to circulate. If you are firing dense loads (such as tiles) you may want to consider one of our powered bottoms. A powered downdraft vent such as our Vent-Sure system will also help.

Why don't other manufactures use Element Holders?

We invented them, they are patented and they are expensive.

What is so great about Dyna-Glow Element Holders? Why pay the extra money?

There are two incontestable reasons. One, your kiln will last much longer. We have seen L&L kilns that are 20 and even 30 years old that look and function like new kilns. The firebrick around the element grooves in our competitor's kilns is easily subject to breakage. All it takes is a kiln shelf hitting the brick near an element groove and you have a BIG problem. Bang hard on a Dyna-Glow element holder and nothing much happens. The other reason, which is logically clear, is that the wall on the Dyna-Glow element holder that holds the element in is only 1/16" thick and is made of hard dense non-insulating ceramic. This transfers the heat of the element much better than the highly insulating firebrick wall (typically 1/4" or more) that you will find on competitors' kilns. Another great feature is that the expansion and contraction of the element coils does not kick up brick dust, which can get on your precious ware. Element life is longer because elements stay in their hard grooves and don't droop out.

Can I use L&L element holders in another type of kiln to fix it or to make my own kiln?

No. We route a special "T" shaped slot in our firebrick to hold the element holders in place. There is no way easily to do this in another kiln and the required tooling is all special.

Do I need a vent?

Kilns have been operated for years without the newer ventilation systems. Without a vent typically the kiln is vented by propping the lid during the first part of the cycle when the ware gives off fumes. However, a powered downdraft type of vent, like the Vent-Sure that L&L makes, automates this process and improves air circulation and heat distribution in the kiln as well as insures good venting of the fumes to the outside. You MUST be sure to vent fumes generated by a kiln to the outside. Some of these, such as carbon monoxide, are hazardous. A downdraft vent will also help element and thermocouple life because it keeps the kiln full of oxygen, which promotes the proper oxide coatings on those components. See hotkilns.com/install.pdf.

Can I use another brand vent with an L&L kiln?

Yes, you can use an Orton vent or the Skutt Envirovent. However, if you look into the details of these vents you will find our vent system to be superior, safer and more adjustable. Be careful if you DO use one of these vents of two things. One is that they typically come with stands. Sometimes the stands are inferior to ours and are not sized properly. We have seen bottoms cracked as a result. Also sometimes they will be overpowered or underpowered for our kilns. We have seen a large vent used on one of our small kilns and it caused heat-up problems. There is no easy way to adjust these other vents like there is with our kilns.

What about running the kiln at night?

This can be a good idea. Often you can get cheaper electrical rates. Often there is not a voltage drop at night in areas where power conditions are not great. If you do this be careful of conditions near the kiln. You may want to have a good fire alarm or automatic sprinkler system. You will probably need the automatic DynaTrol option to do this because of the easy-to-use Time Delay feature. Also be sure to be around the kiln when it is at the end of its firing to protect against overfiring.

Should I get a powered bottom?

Powered bottoms are available as options on some Jupiter and DaVinci kilns. They are not available on the Easy-Fire kilns. We recommend this option for a few different reasons. 1) If you are firing very dense loads such as tiles. 2) On very large kilns such as the T3400 Series where you could get a cold spot in the floor – improves uniformity. 3) To decrease cycle time and add KW to the kiln – not normally an issue with ceramics but it can be

FREQUENTLY ASKED QUESTIONS

for some industrial processes. 4) To increase the temperature rating of a J23 or J2918 kiln. Another benefit of a powered bottom is that it increases the element life by allowing all the elements to work less hard to achieve the same results.

Does it make sense to buy a J18, J23 or J2918 and then add a section to it later?

The J18, J23 and J2918 control panels all come with three-zone capability. Therefore you can easily add a section later to make the kiln into either a J18X, J230 or J2927. The cost is just slightly higher plus, of course, the cost of shipping. For larger kilns like the J230 or J2927, if you anticipate making the kiln larger, you should special order a larger control panel (four or five zones). Contact the factory for more information.

Can I buy kiln furniture separately rather than in the kits mentioned for each model?

You can buy shelves and posts separately in any combination. There is a slight discount for buying it in the kit form but not enough to deter you from buying exactly what you need for the way you load your kiln.

Where should I put my kiln?

Your kiln should be in a covered enclosed space. A basement or garage is usually a good location. Preferably the floor should be concrete. There must be at least 12” from the walls of the kiln to any walls of the room. Keep all flammables away from the kiln. Room should be vented with either good natural ventilation or forced ventilation fan. See hotkilns.com/preorder.pdf for a great pre-order checklist and description of various important considerations you need to make before you buy a kiln.

Can I keep my kiln in an unheated shed?

Yes. Lack of heat will not harm the kiln. The kiln is made for extreme expansion and contraction. However, you don't want the kiln to get moist from condensation and then freeze because this could harm the brick. The specification on the control puts its operating temperature range between 0 and 125 Deg F. However, the low temperature will mostly affect how accurate the control will be – not an important consideration when you are first starting a firing (unless you are candling). As the kiln heats up it should bring the ambient temperature up to a reasonable degree and allow the control to function properly. On the other hand, very hot outdoor sheds could present a problem for the control overheating. You may need to blow a small fan on the control in extreme circumstances.

Can I put my kiln directly on the floor?

No. You must have an air space between the kiln bottom and the floor. This is true even for a cement floor. The water in the cement could cause a mini explosion and at least spalling. A kiln sitting on a flammable floor such as a wood floor could very well cause a fire – even if it doesn't seem like it is getting too hot at first. Over time a wood floor could dry out and become more flammable. Be very careful with any flammable floors and be sure to have an adequate insulator over it like cinder blocks and then put our stand on top of that. Be sure to monitor the heat in the floor occasionally if the potential for a fire exists. Basically, you do not want to have direct contact between the kiln bottom and anything that will conduct heat.

Where can I get good information on how to fire my kiln?

We include many firing tip brochures from Orton. For a more in depth explanation Orton has a great booklet called Successful Firing Practices. They also have a number of other booklets available such as Cones and Firing (20 pages), Using Orton Cones/Temperature Charts, Kiln Safety Booklet, Kiln-Sitter Maintenance & Repair and Porcelain Firing Guide. Contact Orton at 614-895-2663 for more information. In addition L&L has available a book called Electric Kiln Ceramics written by Richard Zakin. This is an excellent in depth review of clays, glazes and techniques developed exclusively for use in an electric kiln. We also sell What Every Potter Should Know, 222 pages, by Jeff Zamek. Author Jeff Zamek has researched just about every mishap that can occur in ceramics and has learned how to either prevent or correct them. He provides information in easy to grasp segments to guide you through new glaze formulas, new clay body formulas, kiln firing techniques, clay/glaze defects, and much more. We also sell Mastering Cone 6 Glazes by Ron Roy and John Hasselberth – a great book about making and firing wonderful “reduction quality” Cone 6 glazes in an automatic electric kiln. See hotkilns.com/books.pdf for more details. Also see our Troubleshooting Guide (hotkilns.com/trouble.pdf) which has a whole section on typical ceramic firing problems.

FREQUENTLY ASKED QUESTIONS

ELECTRICAL QUESTIONS

Do I need a separate electrical line for my kiln?

We recommend that you install your kiln on a separate line coming out of your main electrical box. It should have its own circuit breaker or fused disconnect switch. See hotkilns.com/preorder.pdf for a great pre-order checklist and description of various important considerations you need to make before you buy a kiln.

How do I know if I have 240 or 208 volts and single or three phase?

Most household electrical current is 240 volts, single phase. Industrial or commercial can be anything. If you aren't sure ask your electrical utility company or an electrician. It is important to know because it can be expensive to convert a kiln from one voltage to another. See hotkilns.com/volts.pdf for more information.

Is three phase cheaper to run than single phase.

Not normally. You still use the same amount of KW hours regardless of the phase of the power. In some areas there may be cheaper rates for three phase power so you might check on this if three phase is available to you. The main reason that three phase is used is that the size of the wires and circuit breaker or fused disconnect is dramatically smaller than with single phase for the same amount of KW This is particularly important for larger kilns. On our Easy-Fire kilns we take advantage of the fact that we can get more power from 3 phase and still keep under the 48 amp limit for the power cord.

What do I do if I ordered the wrong voltage or phase?

Depending on the kiln it may be possible to switch the phase easily at our factory by sending in the control panel. This is possible for almost all Jupiter and DaVinci kilns. We can also instruct your electrician in how to do this. If you ordered a 240 volt kiln and you have 208 volts you will get about 25% less power out of the kiln. If you can live with this then you may not have to do anything. If you need the full power you will need to change all the elements to 208 volt elements. If you ordered a 208 volt kiln and you have 240 volts you must change the elements because the kiln will draw too much power and you will burn out the electricals inside the control box to say nothing of what you could do to your own power lines. While we do not accept responsibility for such mistakes we do our best to minimize the expense. Call the factory if this happens and we will sell you a set of appropriate elements at a deep discount.

PARTS, SERVICE AND INSTRUCTIONS FOR L&L KILNS

I just bought an old L&L kiln and its in great shape. How do I get instructions?

You can download almost all our instructions (including those for older models) from our PDF Library (hotkilns.com/pdf.htm). Or send a check to L&L Kiln Mfg for \$25 along with the model and serial number of the kiln. We will send you a complete instruction manual, wiring diagram, troubleshooting guide, parts list, etc.

How old is my kiln?

Look at the Serial Number. Usually the last two digits are the year in which it was made. For instance a kiln with the Serial Number 0992A would have been made in 1992.

Where can I get parts?

Parts are available direct from the factory. We typically ship the day after we get an order. We can ship next day air if you are in a rush. We accept Visa, Mastercard and American Express. Some distributors also stock parts and you can order through them if you prefer.

Are parts available for all L&L kilns?

Just about. Certainly all Easy-Fire, Jupiter, J Series, K Series, DaVinci X & T Series, OV Oval Series, SQ Series, H & C Series. Some brick may not be available. Elements are almost never a problem. Some unusual old electrical parts are not available. We made a few odd kilns in the 40's and 50's that we may not be able to help you with.

FREQUENTLY ASKED QUESTIONS

Why should I use L&L elements?

Replacement elements made by L&L Kiln Mfg., Inc. are designed for each individual model for long life and superior performance. Good element design is a complex balance of watt density, design voltage, stretch ratio, wire gauge, element length and material. It takes hours and years of experience to design a good element for each model. Do not expect an outside supplier with no interest in your kiln performance or long experience with L&L kilns to spend the necessary time to do this right. In the end you will not save money.

What can I do to improve element life?

See hotkilns.com/elements.pdf. Consider heavy duty elements. They are standard on Easy-Fire and DaVinci kilns and an option on Jupiter kilns (and some older J Series Econo-kilns). These elements are heavier gauge wire and lower watt density than the standard elements. They require a larger element holder (which is used on all J Series kilns manufactured after Jan 1, 1996).

My kiln is taking longer and longer to heat up. What is the problem?

Chances are the elements have aged. See our troubleshooting guide at hotkilns.com/trouble.pdf.

My thermocouples keep burning out. What can I do to improve thermocouple life?

If you are using 14 gauge thermocouples at least upgrade to 8 gauge (these use thicker wire). However, for ultimate performance the best Type K thermocouple available is the 8 gauge thermocouple with the industrial mullite protection tube. Platinum thermocouples (which are very expensive) can work with the DynaTrol but the DynaTrol has to be specially rebuilt. See hotkilns.com/stc.pdf. Type S thermocouples will not work with the Truview Pyrometer System.

Is there a temporary fix for a broken thermocouple?

If you have one of the exposed Type K thermocouples you can break away some of the ceramic at the end and twist the two wires together. Or you can use an acetylene torch to reweld the tip (using Borax to dip the hot tip into afterwards to prevent undue oxidation). This may get you by for a little while. There is no way to repair one of the industrial thermocouples.

Where can I get service?

We keep a binder with the names of local kiln service people that we find out about. Call us for a name and we'll see if we can help you. Check our distributor list. Most of our distributors provide repair service. Check the local yellow pages. L&L kilns are designed for easy service and most of our customers do their own service. Most qualified electricians should be able to help with service. L&L kilns are perhaps the simplest kiln on the market in terms of repair ability so most people are either able to do their own repair work or find a competent non-specialist to help.

Expert Instrument Panel Repair

If you have a problem that you are unable to fix yourself with a Econo-Kiln, Jupiter or DaVinci instrument panel you can send it to L&L for inspection and/or repair. Remove it from the panel (you may want to leave the Dawson kiln sitter attached) and carefully pack it and send by UPS. L&L will inspect it and advise you of repair charges before proceeding. There is a non-refundable \$25 inspection/handling fee for this service. Repair charges are extra but there is no extra handling or packing charge to send it back, only the cost of UPS charges. Sorry, we can not estimate repair costs over the phone. The worse case is, of course, that you would need to buy a new instrument panel. If this is advised L&L will apply the \$25 inspection fee against the cost of a new panel. We charge \$55 per hour for our shop time. (How much does your service person charge per hour? Do they charge for travel? Do they know everything about your control?). PLEASE CALL OUR SERVICE DEPARTMENT BEFORE SENDING YOUR PANEL.



2011 Price List and Mini-Catalog

Effective January 1, 2011 (Revised 5-15-11)

(Introducing new Quad options across most of the top-loading product line)

Easy-Fire Kilns with Dynamic Zone Control	Page 2
Easy-Fire XT Square Kilns with Dynamic Zone Control.....	Page 2
School Master K-12 School Kilns with One-Touch™ Control	Page 3
Hercules Medium-Sized Front-Loading Kilns with Dynamic Zone Control.....	Page 3
Jupiter Customizable Kilns with Dynamic Zone Control	Page 4
eQuad-Pro Production Kilns with Dynamic Zone Control	Page 5
JH Series Crystalline Glaze Kilns Kilns with Dynamic Zone Control.....	Page 5
Easy-Load Large Front-Loading Kilns with Dynamic Zone Control	Page 6
DaVinci Square and Rectangular Production Kilns with Dynamic Zone Control.....	Page 7
Jupiter Manual Customizable Kilns with Kiln Sitter and Manual Zone Control.....	Page 8
Dura-Fire Manual Kilns with Kiln Sitter and Hi-Medium-Low Control	Page 9
Pyrometers	Page 9
Liberty-Belle Hobby Kilns with One-Touch™ Control	Page 10
Doll/Test Kilns with Three Control Options (One-Touch™, DynaTrol or Kiln Sitter)	Page 10,11
Accessories (Vents, Misc).....	Page 11
Shelves and Posts.....	Page 12

Prices are subject to change without notice. All prices are FOB Swedesboro, NJ. All kilns ship Class 85. All shipping weights are approximate. Packaging is included in the price (except for shelves which go by common carrier and some export crating which will be quoted). All kilns include L&L's Standard Limited Three-Year Warranty except for the School-Master kilns which include a special Five-Year Limited Warranty. Kilns are not returnable. See hotkilns.com/policies for all L&L policies.

Orders are accepted by phone, fax or email. Accepted forms of payment are Visa, Mastercard or American Express. Wire transfer is welcome (contact office for details). Terms are available for most schools and institutions and for companies with good D&B ratings.

Toll Free: 888.683.7472

505 Sharptown Road, Swedesboro, NJ 08085

Phone: 856-294-0077 Fax: 856-294-0070 Email: sales@hotkilns.com Web: hotkilns.com

EASY-FIRE KILNS WITH DYNAMIC ZONE CONTROL

Model No.	Kiln Price	Furn Kit	Quad Elem	No. Shelves F=full, H=half	Brick Thick	Inside Diam	Inside Height	Cubic Feet	Exterior Dimensions (in)	240/1 KW-Amp-Fuse	240/3 KW-Amp-Fuse	208/1 KW-Amp-Fuse	208/3 KW-Amp-Fuse	Lbs Kiln	Lbs w/Kit
e18S	\$1675	\$285	\$250	15-1/2" (1F, 4H)	2-1/2"	17-1/2"	18"	2.6	29W x 31H x 30D	5.7~23.9~30	5.7~18.9~30	5.0~23.9~30	5.0~18.9~30	190	245
e18S-3	\$1725	\$285	\$250	15" (1F, 4H)	3"	16-1/2"	18"	2.5	29W x 32H x 30D	5.7~23.9~30	5.7~18.9~30	5.0~23.9~30	5.0~18.9~30	220	255
e18T	\$2225	\$325	\$375	15-1/2" (2F, 4H)	2-1/2"	17-1/2"	27"	3.9	29W x 40H x 30D	8.4~35.0~50	8.4~20.2~30	8.4~40.4~60	8.4~23.3~30	230	305
e18T-3	\$2300	\$325	\$375	15" (2F, 4H)	3"	16-1/2"	27"	3.7	29W x 41H x 30D	8.4~35.0~50	8.4~20.2~30	8.4~40.4~60	8.4~23.3~30	255	325
e23S	\$2250	\$325	\$300	21" (1F, 4H)	2-1/2"	23-3/8"	18"	4.7	31W x 32H x 42D	9.5~39.4~50	9.5~31.2~40	8.3~40.0~50	8.3~31.6~40	265	350
e23S-3	\$2350	\$325	\$300	20" (1F, 4H)	3"	22-3/8"	18"	4.4	31W x 33H x 42D	9.5~39.4~50	9.5~31.2~40	8.3~40.0~50	8.3~31.6~40	305	375
e23T	\$2775	\$400	\$450	21" (2F, 4H)	2-1/2"	23-3/8"	27"	7.0	31W x 41H x 42D	11.5~48.0~60	11.5~27.7~40	10.0~48.0~60	11.0~30.5~40	325	420
e23T-3	\$2875	\$400	\$450	20" (2F, 4H)	3"	22-3/8"	27"	6.7	31W x 42H x 42D	11.5~48.0~60	11.5~27.7~40	10.0~48.0~60	11.0~30.5~40	360	455
e28S-3	\$2775	\$505	\$400	25-1/2" (6H)	3"	28"	18"	6.8	37W x 33H x 48D	11.5~47.9~60	11.5~37.9~50	10.0~48.0~60	10.0~38.0~50	370	470
e28T-3	\$3300	\$615	\$600	25-1/2" (8H)	3"	28"	27"	10.2	37W x 42H x 48D	11.5~48.0~60	16.6~40.0~50	10.0~48.0~60	14.3~39.8~50	460	565

Furniture Kit: includes the shelves listed above plus six (6) each of 1/2", 1", 2", 4", 6" and 8" high square posts, plus insulated gloves for unloading, and 5 lbs of Cone 10 kiln wash. **Cone Rating:** All models are rated to Cone 10 except the e28T-3 which is rated to Cone 8 at 240V/1 Phase, Cone 5 at 208V/1 Phase and Cone 10 for any 3 phase kiln. **More:** See various Easy-Fire Specification Sheets at hotkilns.com additional information like shipping dimensions, electrical ratings, fuse sizes and wire connection sizes. See hotkilns.com/Spec-Zone-Control and DynaTrol for information about the control system.

This is the classic L&L multi-purpose kiln.



Standard Features

24-Key DynaTrol with Dynamic Zone Control (two zones for "S" models and three zones for "T" models) • Type K 8 gauge thermocouples with ceramic protection tubes • Piggy-back control panel with drop-down front panel for easy maintenance • Full support 14 gauge aluminized steel stand • Solid peephole plugs with full 1" view (no tapering) • Hard ceramic element holders • Proprietary reflective brick coating that protects brick and keeps dusting down • "Easy-Lift, Easy-Load" stainless steel spring hinge system with full-support when door is up and tilted back (there are no support bars to get in the way of loading) (Spring hinge not available on e18S & e18T models) • Mercury-free relays • Plugs on all USA models (6-50 on single phase and 15-50 on three phase) • c-MET-us listed to UL499 standards • Three-year Limited Warranty • Skidded Carton with foam-in-place packaging for Common Carrier

Voltage & Element Options

240 or 208, 1 phase or 3 phase are all standard options. no charge
 220 volts single phase or 380 volts Wye or Delta (for non-USA installations) no charge
 Quad Element System (watts & amps do not change - elements doubled & more massive with Quad system).... See above

Control Options

Pyrocoil metal-sheathed thermocouple (instead of 8 ga TCs with ceramic protection tubes).....no charge
 Type S platinum thermocouples (2 required for 18" High "S" models, 3 required for 27" High "T" models)\$175 each
 KISS Computer Software to monitor control with USB connector for computer.....\$575

Vent System

Vent-Sure Downdraft Kiln Vent System (See page 11)\$440

EASY-FIRE XT SQUARE KILNS WITH DYNAMIC ZONE CONTROL

Model No.	Kiln Price	Furn Kit	High Power	Quad Elem	Shelves in Furniture Kit	Inside W x D	Inside Height	Cubic Feet	External Dimensions	Stand High KW	240/1 KW	240/3 KW	208/1 KW	208/3 KW	Lbs Kiln	Lbs w/Kit	
XB2318-EZ	\$3400	\$350	n/a	\$350	(4) 20" x 10"	22" Square	18"	5.0	40W x 32H x 42D	8.9	n/a	37.2~50	32.2~40	42.9~60	37.2~50	500	550
X2327-EZ	\$3825	\$440	\$30	\$525	(6) 20" x 10"	22" Square	27"	8.1	40W x 41H x 42D	11.7	13.4	48.8~60	28.2~40	56.3~70	32.5~40	600	665
XB2818-EZ	\$4125	\$385	n/a	\$400	(4) 23" x 11-1/2"	26-1/2" Square	18"	7.8	45W x 32H x 43D	11.6	n/a	48.3~60	41.8~60	55.7~70	48.3~60	625	695
X2827-EZ	\$5075	\$495	\$55	\$600	(6) 23" x 11-1/2"	26-1/2" Square	27"	11.7	45W x 41H x 43D	14.9	17.4	62.2~80	35.9~50	71.8~90	41.5~60	735	835

Furniture Kit: includes the shelves listed above plus six (6) each of 1/2", 1", 2", 4", 6" and 8" high square posts, plus insulated gloves for unloading, and 5 lbs of Cone 10 kiln wash. **Cone Rating:** All models are rated to Cone 10. **More:** See hotkilns.com/Spec-Easy-Fire-XT.pdf for additional information like shipping dimensions, electrical ratings, fuse sizes and wire connection sizes. See hotkilns.com/Spec-Zone-Control and hotkilns.com/Spec-DynaTrol.

Standard Features

The Easy-Fire XT Square kilns feature a square body shape as used in our DaVinci Series • Stainless steel spring hinge as used on the Easy-fire kilns • 3" brick • Three elements per 9" section • Strong arched sides with extra space added to interior dimensions for good air circulation • Series of strong aluminized stands • Hinged control panel for easy maintenance mounted on the element box • Automatic 24-Key DynaTrol with Dynamic Zone control (two zone for 18" models and three zone for 27" models) • Type K 8 gauge thermocouples with ceramic protection tubes • Solid peephole plugs with full 1" view (no tapering) • Hard ceramic element holders • Proprietary reflective brick coating that protects brick and keeps dusting down • Mercury-free relays • Direct wire • Three-year Limited Warranty • Skidded Carton or Crate for Common Carrier

Voltage & Element Options

240 or 208, 1 phase or 3 phase are all standard options. no charge
 220 volts single phase or 380 volts Wye or Delta (for non-USA installations) no charge
 Quad Element System (watts & amps do not change - there are two doubled elements instead of the normal three) See above

Control and Vent Options

See above options for Easy-fire Kilns.



SCHOOL-MASTER K-12 SCHOOL KILNS WITH ONE-TOUCH™ CONTROL

Model No.	Kiln Price	Furn Kit	No. of Shelves F=full, H=half	Brick Thick	Inside Diam	Inside Height	Cubic Feet	Exterior Dimensions	240/1 KW~Amp~Fuse	240/3 KW~Amp~Fuse	208/1 KW~Amp~Fuse	208/3 KW~Amp~Fuse	Lbs Kiln	Lbs w/Kit
SM23T	\$2575	\$400	21" (2F, 4H)	2-1/2"	23-3/8"	27"	7.0	31W x 41H x 42D	11.5~48.0~60	11.5~27.7~40	10.0~48.0~60	11.0~30.5~40	325	420
SM23T-3	\$2675	\$400	20" (2F, 4H)	3"	22-3/8"	27"	6.7	31W x 42H x 42D	11.5~48.0~60	11.5~27.7~40	10.0~48.0~60	11.0~30.5~40	360	455
SM28T-3	\$3100	\$615	25-1/2" (8H)	3"	28"	27"	10.2	37W x 42H x 48D	11.5~48.0~60	16.6~40.0~50	10.0~48.0~60	14.3~39.8~50	460	565

Furniture Kit: includes the shelves listed above plus six (6) each of 1/2", 1", 2", 4", 6" and 8" high square posts, plus insulated gloves for unloading, and 5 lbs of Cone 10 kiln wash. You can substitute two half shelves for one full shelf at no charge. **Cone Rating:** All models rated for Cone 6 except for the SM28T-3, 208V/1 phase which is rated for Cone 5. **More:** See hotkilns.com/Spec-School-Master for additional information like shipping dimensions, electrical ratings, fuse sizes and wire connection sizes. Also see hotkilns.com/Spec-One-Touch for more information about the One-Touch™ control. See hotkilns.com/five-year-warranty for information about the K-12 Five-Year Warranty.

Standard Features

SPECIAL FIVE-YEAR LIMITED WARRANTY. Proprietary One-Touch™ Intuitive Kiln Control is designed for busy school teachers - One touch and you are ready to fire the bisque and glaze programs typically used in schools (also easy to adjust simple parameters like cone, delay, hold, heat-up and cool-down rates). You can even create four custom ramp/hold programs. • Type K 8 gauge thermocouple with protection tube • Single zone with graded elements • Full support 14 gauge aluminized steel stand • Three solid peephole plugs with full 1" view (no tapering) • Hard ceramic element holders • Proprietary reflective brick coating that protects brick and keeps dusting down • "Easy-Lift, Easy-Load" stainless steel spring hinge system with full-support when door is up and tilted back (there are no support bars to get in the way of loading) • Mercury-free relays • Plugs on all USA models (6-50 on single phase and 15-50 on three phase) • c-MET-us listed to UL499 standards • Skidded Carton with foam-in-place packaging for Common Carrier

5-YEAR WARRANTY



NEW

This is the new standard for school kilns.

Voltage Options

240 or 208, 1 phase or 3 phase no charge
 220 volts single phase or 380 volts Wye or Delta (for non-USA installations) no charge

Vent System

Vent-Sure Downdraft Kiln Vent System (See page 11)\$440

HERCULES MEDIUM SIZE FRONT-LOADING KILNS WITH DYNAMIC ZONE CONTROL

Model No.	Furn Price	Kit	Inside Dimensions	Cubic Feet	Hearth Size	Shelves in Furniture Kit	Hearth Height	KW	240/1 Amp~Fuse	240/3 Amp~Fuse	208/1 Amp~Fuse	208/3 Amp~Fuse	480/3 Amp~Fuse	Lbs Kiln	Lbs w/Kit
EL2424-H	\$7375	\$350	25W x 26D x 24H	8	22" x 22"	(4) 11" x 22"	30"	15.0	63.0~80	55.0~70	73.0~90	63.0~80	28.0~40	1075	1250
EL2427-H	\$7975	\$455	25W x 26D x 27H	9	22" x 22"	(6) 11" x 22"	30"	15.0	63.0~80	55.0~70	73.0~90	63.0~80	28.0~40	1200	1450

Furniture Kit: includes the shelves listed above plus six (6) each of 1/2", 1", 2", 4", 6" and 8" high square posts, plus insulated gloves for unloading, and 5 lbs of Cone 10 kiln wash. **Cone Rating:** Cone 10 **More:** See hotkilns.com/Spec-Hercules.pdf for additional information like shipping dimensions, electrical ratings, fuse sizes and wire connection sizes. See hotkilns.com/Spec-Zone-Control.pdf and DynaTrol.pdf for information about the control system.



NEW LARGER SIZE



This is the best value in medium-sized front-loading kilns. Elements in the door, gasketed plug door, arched roof, door shut-off switch - all are standard at an excellent price. Now there are two sizes - a 24" high and a 27" high model.

Standard Features

Adjustable door • Plug seal with gasket • Heavy 12 gauge welded case with separate but attached stand • Leveling pads • Extra-tough K25 2500°F 4-1/2" firebrick arch • Other insulation is 3" of K23 brick with 2" of mineral wool backup insulation • Elements on door, sides and back • 24-Key DynaTrol with Dynamic Zone Control • Type K 8 gauge thermocouples with ceramic protection tubes • Control panel mounted with air space between it and the case • Branch fusing in control • Two solid peephole plugs with full 1" view (no tapering) in the door • Hard ceramic element holders • Proprietary reflective brick coating that protects brick and keeps dusting down • Door power safety shut-off switch • Direct wire • Mercury-free relays • MET-us listed to UL499 standards • The kiln will fit through a 34-1/2" wide door without disassembly or removal of door • Crated with interior support and air-cushion skids. Shipping arrangements must be made by factory (see hotkilns.com/front-loader-installation-checklist.pdf)

Voltage Options

See all control voltage options for the Easy-Load Kilns on Page 6.

Control Options

See all control options for the Easy-Load Kilns on Page 6.

Hinge Mounting

Hinge mounted on right and panel mounted on left (production delay for this).....\$800

FOR LARGE FRONT-LOADING KILNS SEE PAGE 6

JUPITER CUSTOMIZABLE KILNS WITH DYNAMIC ZONE CONTROL

Model No.	Kiln Price	Powered Bottom	Furn Kit	Quad Elem	No. of Shelves F=full, H=half	Inside Diam	Inside Height	Cubic Feet	Cone Rating	240/1 KW-Amp-Fuse	240/3 KW-Amp-Fuse	208/1 KW-Amp-Fuse	208/3 KW-Amp-Fuse	Lbs Kiln	Lbs w/Kit
JD Jupiter Automatic Kilns with 2-1/2" Brick															
JD18	\$1725	n/a	\$285	\$250	15-1/2" (1F, 4H)	17-1/2"	18"	2.6	10	5.5~23.0~30	5.5~19.9~30	5.5~26.5~30	5.5~23.0~30	200	245
JD18X	\$2400	n/a	\$325	\$375	15-1/2" (2F, 4H)	17-1/2"	27"	3.9	10	8.3~34.5~50	8.3~19.9~30	8.3~39.8~50	8.3~23.0~30	245	295
JD23V	\$2275	\$450	\$325	\$300	21" (1F, 4H)	23-3/8"	18"	4.7	5	7.0~29.3~40	7.0~25.4~40	6.1~29.3~40	6.1~25.4~40	275	350
JD230V	\$2825	\$450	\$400	\$450	21" (2F, 4H)	23-3/8"	27"	7.0	10	10.6~44.0~60	10.6~25.4~40	9.1~44.0~60	9.1~25.4~40	330	425
JD236V	\$3400	\$450	\$470	\$600	21" (3F, 4H)	23-3/8"	36"	9.4	10	14.1~58.6~80	14.1~38.1~50	12.2~58.6~80	12.2~38.1~50	360	455
JD245V	\$3975	\$450	\$545	\$750	21" (4F, 4H)	23-3/8"	45"	11.8	10	17.6~73.3~100	17.6~50.8~70	15.2~73.3~100	15.2~50.8~70	445	560
JD2918	\$3200	\$575	\$505	\$350	25-1/2" (6H)	29"	18"	6.9	5	9.1~38.0~50	9.1~32.9~50	8.3~40.0~50	8.3~34.6~50	335	440
JD2927	\$3975	\$575	\$615	\$525	25-1/2" (8H)	29"	27"	10.3	10	13.7~57.0~80	13.7~32.9~50	12.5~60.0~80	12.5~34.6~50	390	520
JD2936	\$5025	\$575	\$735	\$700	25-1/2" (10H)	29"	36"	13.8	10	18.2~76.0~100	18.2~49.3~70	16.6~80.0~100	16.6~52.0~70	480	635
JD2945	\$5925	\$575	\$850	\$875	25-1/2" (12H)	29"	45"	17.2	10	22.8~95.0~125	22.8~65.8~90	20.8~100.0~125	20.8~69.3~90	575	755
JD Jupiter Automatic Kilns with 3" brick															
JD18-3	\$1775	n/a	\$285	\$250	15" (1F, 4H)	16-1/2"	18"	2.5	10	5.5~23.0~30	5.5~19.9~30	5.5~26.5~30	5.5~23.0~30	230	280
JD18X-3	\$2500	n/a	\$325	\$375	15" (2F, 4H)	16-1/2"	27"	3.7	10	8.3~34.5~50	8.3~19.9~30	8.3~39.8~50	8.3~23.0~30	270	320
JD23V-3	\$2400	\$450	\$325	\$300	20" (1F, 4H)	22-3/8"	18"	4.5	5	7.0~29.3~40	7.0~25.4~40	6.1~29.3~40	6.1~25.4~40	315	340
JD230V-3	\$2950	\$450	\$400	\$450	20" (2F, 4H)	22-3/8"	27"	6.7	10	10.6~44.0~60	10.6~25.4~40	9.1~44.0~60	9.1~25.4~40	385	470
JD236V-3	\$3550	\$450	\$470	\$600	20" (3F, 4H)	22-3/8"	36"	8.9	10	14.1~58.6~80	14.1~38.1~50	12.2~58.6~80	12.2~38.1~50	460	545
JD245V-3	\$4200	\$450	\$545	\$750	20" (4F, 4H)	22-3/8"	45"	11.1	10	17.6~73.3~100	17.6~50.8~70	15.2~73.3~100	15.2~50.8~70	540	650
JD2918-3	\$3300	\$575	\$505	\$350	25-1/2" (6H)	28"	18"	6.8	5	9.1~38.0~50	9.1~32.9~50	8.3~40.0~50	8.3~34.6~50	380	480
JD2927-3	\$4125	\$575	\$615	\$525	25-1/2" (8H)	28"	27"	10.2	10	13.7~57.0~80	13.7~32.9~50	12.5~60.0~80	12.5~34.6~50	450	575
JD2936-3	\$5250	\$575	\$735	\$700	25-1/2" (10H)	28"	36"	13.6	10	18.2~76.0~100	18.2~49.3~70	16.6~80.0~100	16.6~52.0~70	565	715
JD2945-3	\$6225	\$575	\$850	\$875	25-1/2" (12H)	28"	45"	17.0	10	22.8~95.0~125	22.8~65.8~90	20.8~100.0~125	20.8~69.3~90	645	820

Note: All the J2300 series are available with higher watts "EZ" elements (the same elements used in the e23T kilns) at no extra charge. Contact factory for details. **Furniture Kit:** includes the shelves listed above plus six (6) each of 1/2", 1", 2", 4", 6" and 8" high square posts, plus insulated gloves for unloading, and 5 lbs of Cone 10 kiln wash. You can substitute two half shelves for one full shelf at no charge. **Cone Rating:** See above chart. **More:** See various Jupiter Automatic specification sheets at hotkilns.com/pdf for additional information like shipping dimensions, electrical ratings, fuse sizes and wire connection sizes. See hotkilns.com/Spec-Zone-Control and hotkilns.com/Spec-DynaTrol for information about the control system.

Standard Features

Automatic 24-Key DynaTrol with zone control • Kiln sections plug into separate control panel • Type K 8 gauge thermocouples with ceramic protection tubes • Separate control box with plug-in sections • Full support 14 gauge aluminumized steel stand • Solid peephole plugs with full 1" view (no tapering) • Hard ceramic element holders • Proprietary reflective brick coating that protects brick and keeps dusting down • "Easy-Lift, Easy-Load" stainless steel spring hinge system with full-support when door is up and tilted back (there are no support bars to get in the way of loading) is standard on all 12 and 10 sided models (29", 28", 22" and 23" diameter), Not available on the 8 sided (17-1/2" and 16-1/2" diameter models) • Branch fusing on all models above 50 amps • 6-50 plug on JD18, JD18X, JD23, JD230 and JD230-EZ single phase models. 15-50 plug on JD18, JD18X, JD23, JD230 and JD230-EZ three phase models. All other models are direct wire • Mercury-free relays • c-MET-us listed to UL499 standards • Three-year Limited Warranty • Skidded Carton with foam-in-place packaging for Common Carrier

Voltage & Element Options

240 or 208, 1 phase or 3 phase no charge
 220 volts single phase or 380 volts Wye or Delta (for non-USA installations) no charge
 480 volts/3 phase\$650
 (needs NEMA1 panel for MET-us listing) (sections hard wired to power box)
 NEMA 1 Control box for industrial use (MET-us listed with this extra option for 480 volts).....\$650
 Quad Element System (watts & amps do not change from the standard models. For JD1800 & JD2300 elements are doubled & more massive with Quad system. For JD2900 there are two doubled elements instead of the normal three) See above

Pull-Apart Option for Sculpture

"Pull-Apart" Option for sculpture. Includes floor mount stand for control panel, lift off lid with extra handles but no hinge. This option allows the entire kiln to be dismantled to make it easy to load large sculptural pieces. The kiln sections are unplugged and then taken off one at a time. There is no charge for this option. However, If you want the "Easy-Lift, Easy-Load" spring hinge with it there is a \$175 extra charge.

Control Options

An Orton Kiln Sitter is available as safety backup to the automatic control\$600
 120 volt power supply with electrical noise filter for the automatic control.....\$175
 Pyrocil metallic type K thermocouples instead of 8 ga type K TCs with ceramic protection tubes no charge
 Type S platinum thermocouples (2 required for 18" kilns, 3 required for all other models).....\$175 each
 KISS Computer Software to monitor control with USB connector\$575

Vent System

Vent-Sure Downdraft Kiln Vent System (See page 11)\$440



Jupiter kilns are highly customizable, with tall heights possible (even taller than what is shown here. They are easy-to stack and disassemble because of the plug-in sections-great for sculpture.

eQUAD-PRO PRODUCTION KILNS WITH DYNAMIC ZONE CONTROL

Model No.	Kiln Price	Furn Kit	No. of Shelves F=full, H=half	Inside Diam	Inside Height	Cubic Feet	Exterior Dimensions	240/1 KW-Amp-Fuse	240/3 KW-Amp-Fuse	208/1 KW-Amp-Fuse	208/3 KW-Amp-Fuse	Lbs Kiln	Lbs w/Kit
eQ2327-3	\$3550	\$400	20" (2F, 4H)	22-3/8"	27"	6.7	31W x 42H x 42D	13.4~56.0~70	13.4~32.4~50	11.7~56.0~70	11.7~32.4~50	365	485
eQ2827-3	\$4100	\$615	25-1/2" (8H)	28"	27"	10.2	37W x 42H x 48D	15.0~62.3~80	15.0~36.0~50	15.0~71.9~90	15.0~41.5~60	480	585
eQ2836-3	\$4800	\$735	25-1/2" (10H)	28"	36"	13.6	37W x 51H x 48D	19.0~79.2~100	19.0~51.5~70	19.0~91.3~125*	19.0~59.4~80	595	725

*Note: Special model eQ2836-X-208-1P is available with 16.6 KW, 208 Volt/1 Phase, 80 amps for a 100 amp fuse. **Furniture Kit:** includes the shelves listed above plus six (6) each of 1/2", 1", 2", 4", 6" and 8" high square posts, plus insulated gloves for unloading, and 5 lbs of Cone 10 kiln wash. **Cone Rating:** Cone 10 **More:** See hotkilns.com/Spec-eQuad-Pro for additional information like shipping dimensions, electrical ratings, fuse sizes and wire connection sizes. See hotkilns.com/Spec-Zone-Control and hotkilns.com/Spec-DynaTrol for information about the control system.

Standard Features

24-Key DynaTrol with Dynamic Zone Control • 3" brick • Quad element system (fours rows of super heavy gauge elements per 9" high section) • Extra power with branch fusing for high production work • Type K 8 gauge thermocouples with ceramic protection tubes • Full support 14 gauge aluminized steel stand • Solid peephole plugs with full 1" view (no tapering) • Hard ceramic element holders • Proprietary reflective brick coating that protects brick and keeps dusting down • "Easy-Lift, Easy-Load" stainless steel spring hinge system with full-support when door is up and tilted back (there are no support bars to get in the way of loading) • Mercury-free relays • Direct wired • MET-us listing to UL499 standards is pending • Three-year Limited Warranty • Skidded Carton with foam-in-place packaging for Common Carrier

Voltage Options

240 or 208, 1 phase or 3 phase no charge
 220 volts single phase or 380 volts Wye or Delta (for non-USA installations) no charge

Control Options

Type S platinum thermocouples (3 required if you want to maintain the 3 zone capability)\$175 each
 KISS Computer Software to monitor control with USB connector for computer.....\$575

Vent System

Vent-Sure Downdraft Kiln Vent System (See page 11)\$440



JH SERIES CRYSTALLINE GLAZE CONE 12 KILNS WITH DYNAMIC ZONE CONTROL

Model No.	Kiln Price	APM Elements	Furn Kit	No. of Shelves F=full, H=half	Inside Diam	Inside Height	Cubic Feet	240/1 KW-Amp-Fuse	240/3 KW-Amp-Fuse	208/1 KW-Amp-Fuse	208/3 KW-Amp-Fuse	Lbs Kiln	Lbs w/Kit
JD18-JH	\$2525	\$540	\$285	15-1/2" (1F, 4H)	17-1/2"	18"	2.6	8.8~36.7~60	8.8~31.7~50	8.8~42.3~60	8.8~36.8~50	255	300
e23S-JH	\$2950	\$580	\$325	21" full (1F, 4H)	23-3/8"	18"	4.7	10.5~47.9~60	n/a	10.0~48.0~60	n/a	280	365
JD230-JH	\$4675	\$870	\$400	21" full (2F, 4H)	23-3/8"	27"	7.0	13.7~57.0~80	13.7~32.9~50	12.5~60.0~80	12.5~34.7~50	400	505
JD2927-JH	\$5950	\$990	\$615	25-1/2" (8H)	29"	27"	10.3	18.0~75.2~100	18.0~43.5~60	18.0~86.7~125	18.0~50.1~70	580	710

Furniture Kit: includes high alumina shelves listed above plus six (6) each of 1/2", 1", 2", 4", 6" and 8" high square posts, plus insulated gloves for unloading, and 5 lbs of Cone 10 kiln wash. You can substitute two half shelves for one full shelf at no charge. **Cone Rating:** Cone 12 **More:** See hotkilns.com/Spec-JH for additional information like shipping dimensions, electrical ratings, fuse sizes and wire connection sizes. See hotkilns.com/Spec-Zone-Control and hotkilns.com/Spec-DynaTrol for information about the control system.

Standard Features

These kilns will reach 2400°F (cone 12) • Includes 2-1/2" of K25 2500°F firebrick of sides and bottom with a 3" thick top • Approximately 25% more power than the base models • Quad element holder system with super heavy-duty elements • Type S platinum thermocouples • 24-Key DynaTrol dynamic zone control • Other features that are standard on the base models • Plugs vary with model, voltage and phase. See Specification sheet • Not UL499 Listed • Three-year Limited Warranty • Skidded Carton with foam-in-place packaging for Common Carrier

Voltage Options

240 or 208, 1 phase or 3 phase no charge
 220 volts single phase or 380 volts Wye or Delta (for non-USA installations) no charge

Control Options

KISS Computer Software to monitor control with USB connector for computer..... \$575

Vent System

Vent-Sure Downdraft Kiln Vent System (See page 11) \$440

Custom Variations

We can make a large number of variations on this design - for instance to accommodate industrial processes. We can offer thicker firebrick, multi-layered insulation, many different sizes, more power and many other options too numerous to mention. Please contact the factory to discuss your requirements.



This is the "Thoroughbred" of kilns. Designed specifically for Crystalline Glaze firing - fast, responsive and precise.

EASY-LOAD LARGE FRONT-LOADING KILNS WITH DYNAMIC ZONE CONTROL

Model No.	Price	Furn Kit	Inside Dimensions	Cubic Feet	Hearth Size	Shelves in Furniture Kit	Hearth Height	KW	240/1 Amp-Fuse	240/3 Amp-Fuse	208/1 Amp-Fuse	208/3 Amp-Fuse	480/3 Amp-Fuse	Lbs Kiln	Lbs w/Kit
EL2436	\$11,825	\$705	25W x 25D x 36H	12	22" x 22"	(8) 11" x 22"	29"	19.0	80.0~100	46.0~60	92.0~125	53.0~70	24.0~30	1350	1500
EL2448	\$14,250	\$805	25W x 25D x 48H	16	22" x 22"	(10) 11" x 22"	18"	24.2	101.0~125	59.0~80	117.0~150	68.0~90	30.0~40	1500	1750
EL2848	\$15,350	\$1075	31W x 25D x 48H	20	28" x 24"	(12) 14" x 24"	18"	27.0	113.0~150	66.0~90	130.0~175	75.0~100	33.0~50	1750	2000
EL3048	\$17,775	\$1130	31W x 31D x 48H	25	28" x 28"	(12) 14" x 28"	18"	31.5	132.0~175	76.0~100	152.0~200	88.0~125	39.0~50	2000	2300

Furniture Kit: includes twelve each (two large post kits) 1/2", 1", 2", 4", 6", & 8" high 1-1/2" square ceramic posts, insulated gloves for unloading and 5 lbs of Cone 10 kiln wash. **Cone Rating:** Cone 10 **More:** See hotkilns.com/Spec-Easy-Load for additional information like shipping dimensions, electrical ratings, fuse sizes and wire connection sizes. See hotkilns.com/Spec-Zone-Control and hotkilns.com/Spec-DynaTrol for information about the control system.

Standard Features

Adjustable door • Massive hinge for stability of door • Plug seal with gasket • Heavy 10 gauge welded case with integrated stand • Extra-tough K25 2500°F 4-1/2" firebrick arch • Other insulation is 3" of K23 brick with 2" of mineral wool backup insulation • Elements on door, sides and back • 24-Key DynaTrol with Dynamic Zone Control • Type K 8 gauge thermocouples with ceramic protection tubes • Control panel mounted with air space between it and the case • Branch fusing in control • Three solid peephole plugs with full 1" view (no tapering) in the door • Hard ceramic element holders • Proprietary reflective brick coating that protects brick and keeps dusting down • Door power safety shut-off switch • Direct wire • Mercury-free relays • MET-us listed to UL499 standards • The kiln will fit through a door shown above without disassembly or removal of door • Crated with interior support and air-cushion skids • Shipping arrangements must be made by factory (see hotkilns.com/front-loader-installation-checklist.pdf) • All the kilns except the EL3048 will go through a 34-1/2" wide by 75" high door. The EL3048 needs a minimum door size of 40-1/2" wide by 75" high.



Big, strong, well-built - if you need a large front-loading kiln we have it. L&L has been building front-loading kilns for over 60 years.

Voltage Options

240 or 208, 1 phase or 3 phase are all standard options. KW does not change..... no charge
 220 volts single phase or 380 volts Wye or Delta (for non-USA installations) no charge
 480 volts/3 phase (needs NEMA1 panel for MET-us listing)\$650
 NEMA 1 Control box (MET-us listed with this extra option for 480 volts).....\$650

Control Options

An Orton Kiln Sitter with back up safety contactors to backup to automatic control\$600
 High Limit Electronic Control latching relay and back up safety contactors (alternate to Kiln Sitter back-up).....\$600
 120 volt power supply with electrical noise filter for the automatic control\$175
 Pyrocil metallic type K thermocouples instead of 8 ga type K TCs with ceramic protection tubes..... no charge
 Type S platinum thermocouples (3 required for Easy-Load and Hercules EL2427-R, 2 for Hercules EL2424-H)\$175 each
 KISS Computer Software to monitor control with USB connector for computer\$575

Vent System

Vent-Sure Downdraft Kiln Vent System (See page 11)\$440

Hinge Mounting

Hinge mounted on right and panel mounted on left (Special order: production delay for this)\$800

DAVINCI SQUARE & RECTANGULAR PRODUCTION KILNS WITH DYNAMIC ZONE CONTROL

Model No.	Kiln Price	Power Bottom	High Power	Furn Kit	Quad Elem	Shelves in Furn Kit	Post Kits	Inside W x D	Inside Height	Inside Cubic Feet	External Dimensions	Stand KW	High KW	240/1 Fuse	240/3 Fuse	208/1 Fuse	208/3 Fuse	Lbs Kiln	Lbs w/Kit
XB2318-D	\$4400	n/a	n/a	\$350	\$350	(4) 20" x 10"	(1)	22" Square	18"	5.0	40W x 32H x 42D	8.9	n/a	50	40	60	50	600	650
X2327-D	\$4850	n/a	\$35	\$440	\$525	(6) 20" x 10"	(1)	22" Square	27"	8.1	40W x 41H x 42D	11.7	13.4	60	40	70	40	700	765
X2336-D	\$5500	n/a	\$70	\$675	\$700	(8) 20" x 10"	(2)	22" Square	36"	10.8	40W x 50H x 42D	15.6	17.9	80	60	90	60	775	870
X2345-D	\$6100	n/a	\$95	\$765	\$875	(10) 20" x 10"	(2)	22" Square	45"	13.5	40W x 59H x 42D	19.5	22.3	100	40	125	80	875	985
XB2818-D	\$5200	\$725	n/a	\$385	\$400	(4) 23" x 11-1/2"	(1)	26-1/2" Square	18"	7.8	45W x 32H x 43D	11.6	n/a	60	60	70	60	725	795
X2827-D	\$6225	\$725	\$60	\$495	\$600	(6) 23" x 11-1/2"	(1)	26-1/2" Square	27"	11.7	45W x 41H x 43D	14.9	17.4	80	50	90	60	835	935
X2836-D	\$6975	\$725	\$95	\$765	\$800	(8) 23" x 11-1/2"	(2)	26-1/2" Square	36"	15.6	45W x 50H x 43D	19.9	23.2	100	70	125	80	935	1075
X2845-D	\$7700	\$725	\$120	\$880	\$1000	(10) 23" x 11-1/2"	(2)	26-1/2" Square	45"	19.5	45W x 59H x 43D	24.9	29.0	125	90	150	100	1050	1220
XB3218-D	\$5925	\$875	n/a	\$460	\$500	(4) 28" x 14"	(1)	30-1/2" Square	18"	10.0	49W x 32H x 49D	14.2	n/a	80	70	90	80	880	985
X3227-D	\$6950	\$875	\$115	\$605	\$750	(6) 28" x 14"	(1)	30-1/2" Square	27"	15.0	49W x 41H x 49D	18.0	21.3	100	60	125	70	1000	1150
X3236-D	\$7875	\$875	\$135	\$905	\$1000	(8) 28" x 14"	(2)	30-1/2" Square	36"	20.0	49W x 50H x 49D	24.4	28.4	125	80	150	100	1135	1340
X3245-D	\$8750	\$875	\$180	\$1060	\$1250	(10) 28" x 14"	(2)	30-1/2" Square	45"	25.0	49W x 59H x 49D	30.5	35.5	175	125	200	125	1275	1525
TB2318-D	\$5850	\$1000	n/a	\$475	\$500	(6) 22" x 11"	(1)	26-1/2" x 34-3/4"	18"	9.7	54W x 32H x 43D	15.3	n/a	80	70	100	80	900	995
T2327-D	\$6850	\$1000	\$115	\$635	\$750	(9) 22" x 11"	(1)	26-1/2" x 34-3/4"	27"	14.6	54W x 41H x 43D	19.5	23.0	100	60	125	70	1035	1175
T2336-D	\$7550	\$1000	\$135	\$955	\$1000	(12) 22" x 11"	(2)	26-1/2" x 34-3/4"	36"	19.4	54W x 50H x 43D	26.0	30.7	125	90	150	100	1165	1355
T2345-D	\$8500	\$1000	\$180	\$1110	\$1250	(15) 22" x 11"	(2)	26-1/2" x 34-3/4"	45"	24.3	54W x 59H x 43D	32.5	38.4	175	125	200	125	1300	1530
TB3418-D	\$6325	\$1175	n/a	\$735	\$600	(6) 28" x 14"	(2)	30-1/2" x 43-1/2"	18"	13.8	62W x 32H x 49D	19.9	n/a	100	90	125	100	1065	1225
T3427-D	\$7400	\$1175	\$135	\$975	\$900	(9) 28" x 14"	(2)	30-1/2" x 43-1/2"	27"	20.7	62W x 41H x 49D	24.9	36.5	125	80	150	90	1225	1455
T3436-D	\$8575	\$1175	\$180	\$1195	\$1200	(12) 28" x 14"	(2)	30-1/2" x 43-1/2"	36"	27.6	62W x 50H x 49D	33.3	39.9	175	125	200	125	1475	1775
T3445-D	\$10025	\$1175	\$205	\$1625	\$1500	(15) 28" x 14"	(3)	30-1/2" x 43-1/2"	45"	34.5	62W x 59H x 49D	41.6	49.8	200	150	225	175	1675	2050

One Large Square Post Kit: includes six each 1/2", 1", 2", 4", 6", & 8" high 1-1/2" square ceramic posts. The Number of post kits varies with model and is shown above. **Furniture Kit:** includes insulated gloves for unloading and 5 lbs of Cone 10 kiln wash. **Cone Rating:** Cone 10 **More:** See various DaVinci specification sheets at hotkilns.com/pdf for additional information like shipping dimensions, electrical ratings, fuse sizes and wire connection sizes. See hotkilns.com/Spec-Zone-Control and hotkilns.com/Spec-DynaTrol for information about the control system.

Standard Features

Counterbalanced Lid with springs inside of tubes • Welded angle-iron stand and hinge system • 3" brick with all brick construction (including lid) • Strong arched sides with extra space added to interior dimensions for good air circulation • Solid peephole plugs with full 1" view (no tapering) • Floor mounted control panel (except for X2300 series) • Branch fusing in control panel • 24-Key DynaTrol with Dynamic Zone Control • Type K 8 gauge thermocouples with ceramic protection tubes • Control mounted in a handheld box with 4' cord • Solid peephole plugs with full 1" view (no tapering) • Hard ceramic element holders • Direct wired • Mercury-free relays • c-MET-us listed to UL499 standards • Three-year Limited Warranty • Wood Crating for Common Carrier. Depending on the model there are either two or three crates

Voltage & Element Options

240 or 208, 1 phase or 3 phase are all standard options. KW does not change.....no charge
 220 volts single phase or 380 volts Wye or Delta (for non-USA installations)no charge
 480 volts/3 phase (sections are hard wired to power box with SO cord) (needs NEMA1 panel for MET-us listing)..... \$650
 NEMA 1 Control box (MET-us listed with this extra option for 480 volts)..... \$650
 Quad Element System (watts & amps do not change - there are two doubled elements instead of the normal three)..... See above

High Power Option

XB and TB elements, which have a higher KW rating, are available on the 27", 36" and 45" high DaVinci kilns. Price adder listed above (High Power column).

Control Options

Manual kiln with manual infinite zone switches and Orton Sitter/Timer instead of 24-Key DynaTrol.....no charge
 An Orton Kiln Sitter with back up safety contactors to backup to automatic control..... \$600
 High Limit Electronic Control latching relay and back up safety contactors (alternate to Kiln Sitter back-up)..... \$600
 120 volt power supply with electrical noise filter \$175
 Pyrocil metallic type K thermocouples no charge
 Type S platinum thermocouples..... \$175 each (2 required for 18" kilns, 3 required for all other models)
 KISS Computer Software to monitor control with USB Connector \$575

Vent System

Vent-Sure Downdraft Kiln Vent System (See page 11) \$440 (Kilns over 20 Cubic feet may need an extra vent)



This is L&L's classic production kiln. Great for Universities too.



Bell Lift Option

Available on any X3200 series or T3400 series.....\$4500
 See hotkilns.com/Spec-Bell-Lift

T644754 (100 cubic feet, 66" W x 47" D x 54" H).....special quote
 See hotkilns.com/ Spec-TB644754

JUPITER CUSTOMIZABLE KILNS WITH KILN SITTER & MANUAL ZONE CONTROL

Model No.	Kiln Price	Powered Bottom	Furn Kit	Quad Elem	No. of Shelves F=full, H=half	Inside Diam	Inside Height	Cubic Feet	Cone Rating	240/1 KW-Amp-Fuse	240/3 KW-Amp-Fuse	208/1 KW-Amp-Fuse	208/3 KW-Amp-Fuse	Lbs Kiln	Lbs w/Kit
Jupiter Manual Kilns with 2-1/2" Brick															
J18	\$1675	n/a	\$285	\$250	15-1/2" (1F, 4H)	17-1/2"	18"	2.6	10	5.5~23.0~30	5.5~19.9~30	5.5~26.5~30	5.5~23.0~30	200	245
J18X	\$2350	n/a	\$325	\$375	15-1/2" (2F, 4H)	17-1/2"	27"	3.9	10	8.3~34.5~50	8.3~19.9~30	8.3~39.8~50	8.3~23.0~30	245	295
J23V	\$2225	\$450	\$325	\$300	21" (1F, 4H)	23-3/8"	18"	4.7	5	7.0~29.3~40	7.0~25.4~40	6.1~29.3~40	6.1~25.4~40	275	350
J230V	\$2775	\$450	\$400	\$450	21" (2F, 4H)	23-3/8"	27"	7.0	10	10.6~44.0~60	10.6~25.4~40	9.1~44.0~60	9.1~25.4~40	330	425
J236V	\$3400	\$450	\$470	\$600	21" (3F, 4H)	23-3/8"	36"	9.4	10	14.1~58.6~80	14.1~38.1~50	12.2~58.6~80	12.2~38.1~50	360	455
J245V	\$3975	\$450	\$545	\$750	21" (4F, 4H)	23-3/8"	45"	11.8	10	17.6~73.3~100	17.6~50.8~70	15.2~73.3~100	15.2~50.8~70	445	560
J2918	\$3200	\$575	\$505	\$350	25-1/2" (6H)	29"	18"	6.9	5	9.1~38.0~50	9.1~32.9~50	8.3~40.0~50	8.3~34.6~50	335	440
J2927	\$3975	\$575	\$615	\$525	25-1/2" (8H)	29"	27"	10.3	10	13.7~57.0~80	13.7~32.9~50	12.5~60.0~80	12.5~34.6~50	390	520
J2936	\$5025	\$575	\$735	\$700	25-1/2" (10H)	29"	36"	13.8	10	16.6~76.0~100	16.6~49.3~70	16.6~80.0~100	16.6~52.0~70	480	635
J2945	\$5925	\$575	\$850	\$875	25-1/2" (12H)	29"	45"	17.2	10	22.8~95.0~125	22.8~65.8~90	20.8~100.0~125	20.8~69.3~90	575	755

Jupiter Manual Kilns with 3" brick

J18-3	\$1725	n/a	\$285	\$250	15" (1F, 4H)	16-1/2"	18"	2.5	10	5.5~23.0~30	5.5~19.9~30	5.5~26.5~30	5.5~23.0~30	230	280
J18X-3	\$2450	n/a	\$325	\$375	15" (2F, 4H)	16-1/2"	27"	3.7	10	8.3~34.5~50	8.3~19.9~30	8.3~39.8~50	8.3~23.0~30	270	320
J23V-3	\$2350	\$450	\$325	\$300	20" (1F, 4H)	22-3/8"	18"	4.5	5	7.0~29.3~40	7.0~25.4~40	6.1~29.3~40	6.1~25.4~40	315	340
J230V-3	\$2900	\$450	\$400	\$450	20" (2F, 4H)	22-3/8"	27"	6.7	10	10.6~44.0~60	10.6~25.4~40	9.1~44.0~60	9.1~25.4~40	385	470
J236V-3	\$3550	\$450	\$470	\$600	20" (3F, 4H)	22-3/8"	36"	8.9	10	14.1~58.6~80	14.1~38.1~50	12.2~58.6~80	12.2~38.1~50	460	545
J245V-3	\$4200	\$450	\$545	\$750	20" (4F, 4H)	22-3/8"	45"	11.1	10	17.6~73.3~100	17.6~50.8~70	15.2~73.3~100	15.2~50.8~70	540	650
J2918-3	\$3300	\$575	\$505	\$350	25-1/2" (6H)	28"	18"	6.8	5	9.1~38.0~50	9.1~32.9~50	8.3~40.0~50	8.3~34.6~50	380	480
J2927-3	\$4125	\$575	\$615	\$525	25-1/2" (8H)	28"	27"	10.2	10	13.7~57.0~80	13.7~32.9~50	12.5~60.0~80	12.5~34.6~50	450	575
J2936-3	\$5250	\$575	\$735	\$700	25-1/2" (10H)	28"	36"	13.6	10	18.2~76.0~100	18.2~49.3~70	16.6~80.0~100	16.6~52.0~70	565	715
J2945-3	\$6225	\$575	\$850	\$875	25-1/2" (12H)	28"	45"	17.0	10	22.8~95.0~125	22.8~65.8~90	20.8~100.0~125	20.8~69.3~90	645	820

Furniture Kit: includes the shelves listed above plus six (6) each of 1/2", 1", 2", 4", 6" and 8" high square posts, plus insulated gloves for unloading, and 5 lbs of Cone 10 kiln wash. You can substitute two half shelves for one full shelf at no charge. **Cone Rating:** See chart above. **More:** See various Jupiter Manual specification sheets at hotkilns.com/pdf for additional information like shipping dimensions, electrical ratings, fuse sizes and wire connection sizes.



This is the original L&L manual kiln with manual infinitely variable zone control.

Standard Features

Orton Kiln Sitter with Timer backup mounted in external box • Infinite Zone Switches for manual zone control of each section • Kiln sections plug into separate control panel • Full support 14 gauge aluminized steel stand • Solid peephole plugs • Hard ceramic element holders • Proprietary reflective brick coating that protects brick and keeps dusting down • "Easy-Lift, Easy-Load" stainless steel spring hinge system with full-support when door is up and tilted back (there are no support bars to get in the way of loading) is standard on all 12 and 10 sided models (29", 28", 22" and 23" diameter), not available on the 8 sided (17-1/2" and 16-1/2" diameter models) • Branch fusing and relays on all models above 50 amps • 6-50 plug on J18, J18X, J23, and J230 single phase models. 15-50 plug on J18, J18X, J23, and J230 three phase models. All other models are direct wire • Mercury-free relays • c-MET-us listed to UL499 standards • Three-year Limited Warranty • Skidded Carton with foam-in-place packaging for Common Carrier

Voltage & Element Options

240 or 208, 1 phase or 3 phaseno charge
 220 volts single phase or 380 volts Wye or Delta (for non-USA installations) no charge
 Quad Element System (watts & amps do not change from the standard models. For JD1800 & JD2300 elements are doubled & more massive with Quad system. For JD2900 there are two doubled elements instead of the normal three)See above

Vent System

Vent-Sure Downdraft Kiln Vent System (See page 11)\$440

Multi-Zone Pyrometer (Tru-View) System

Varies with Number of thermocouples (See Page 11)

Blank Unheated Rings (Can be used on JD Models as well but not on Easy-Fire or Dura-Fire Kilns)

JU18	Blank Ring with no elements - 4-1/2" high for an 8 sided J18 or J18X (R-J-18BK/00)	\$275
JU18-3	Blank Ring with no elements - 4-1/2" high for an 8 sided J18-3 or J18X-3 (R-J-18BK/03)	\$310
JU23	Blank Ring with no elements - 4-1/2" high for a 10 sided J23, J230, J236 or J245 (R-J-23BK/00)	\$315
JU23-3	Blank Ring with no elements - 4-1/2" high for a 10 sided J23-3, J230-3, J236-3 or J245-3 (R-J-23BK/03)	\$325
JU29	Blank Ring with no elements - 4-1/2" high for a 12 sided J2918, J2927, J2936 or J2945 (R-J-29BK/00)	\$415
JU29-3	Blank Ring with no elements - 4-1/2" high for a 12 sided J2918-3, J2927-3, J2936-3 or J2945-3 (R-J-29BK/03)	\$455

(Note: See Jupiter Parts List on the L&L web site for prices of heated rings)

DURA-FIRE MANUAL KILNS WITH KILN SITTER & HI-MED-LOW CONTROL

Model No.	Kiln Price	Furn Kit	Quad Elem	No. of Shelves F=full, H=half	Brick Thick	Inside Diam	Inside Height	Cubic Feet	Cone Rate	External Dimension	240/1 KW-Amp-Fuse	208/1 KW-Amp-Fuse	Lbs Kiln	Lbs w/Kit
D18S	\$1500	\$285	\$250	15-1/2" (1F, 4H)	2-1/2"	17-1/2"	18"	2.6	10	29W x 31H x 30D	6.4~26.6~40	5.5~26.6~40	190	245
D18S-3	\$1550	\$285	\$250	15" (1F, 4H)	3"	16-1/2"	18"	2.5	10	29W x 31H x 30D	6.4~26.6~40	5.5~26.6~40	220	255
D18T	\$2025	\$325	\$375	15-1/2" (2F, 4H)	2-1/2"	17-1/2"	27"	3.9	10	29W x 40H x 30D	9.6~40.0~50	8.3~39.8~40	230	305
D18T-3	\$2100	\$325	\$375	15" (2F, 4H)	3"	16-1/2"	27"	3.7	10	29W x 40H x 30D	9.6~40.0~50	8.3~39.8~40	255	325
D23S	\$1950	\$325	\$300	21" (1F, 4H)	2-1/2"	23-3/8"	18"	4.7	10	31W x 32H x 42D	9.5~39.4~50	8.3~40.0~50	265	350
D23S-3	\$2050	\$325	\$300	20" (1F, 4H)	3"	22-3/8"	18"	4.5	10	31W x 33H x 42D	9.5~39.4~50	8.3~40.0~50	305	400
D23T	\$2575	\$400	\$450	21" (2F, 4H)	2-1/2"	23-3/8"	27"	7.0	10	31W x 41H x 42D	11.5~48.0~60	10.0~48.0~60	325	420
D23T-3	\$2675	\$400	\$450	20" (2F, 4H)	3"	22-3/8"	27"	6.7	10	31W x 42H x 42D	11.5~48.0~60	10.0~48.0~60	360	455
D28S-3	\$2575	\$505	\$400	26" (6H)	3"	28"	18"	6.8	10	37W x 33H x 48D	11.5~47.9~60	10.0~48.0~60	370	470
D28T-3	\$3100	\$615	\$600	26" (8H)	3"	28"	27"	10.2	5 or 8	37W x 42H x 48D	11.5~48.0~60	10.0~48.0~60	460	565

One Large Square Post kit: includes six each 1/2", 1", 2", 4", 6", & 8" high 1-1/2" square ceramic posts. The Number of post kits varies with model and is shown above. **Furniture Kit:** includes insulated gloves for unloading and 5 lbs of Cone 10 kiln wash. **Cone Rating:** All Dura-Fire kilns are rated to Cone 10 except the D28T model. 208 volt D28T reaches cone 5, 240 volt D28T reaches cone 8 **More:** See hotkilns.com/Spec-Dura-Fire for additional information like shipping dimensions, electrical ratings, fuse sizes and wire connection sizes.

This is the most basic and durable kiln we make.



Standard Features

Orton Kiln Sitter with Timer backup mounted in external box • Hi-Medium-Low Switches for each section • Full support 14 gauge aluminized steel stand • Solid peephole plugs • Hard ceramic element holders • Proprietary reflective brick coating that protects brick and keeps dusting down • "Easy-Lift, Easy Load" Spring Hinge is standard on the D28S & D28T, optional on the D23S & D23T and not available on the D18 & D18T models. 6-50 plugs on all USA models. Single phase only. Mercury-free. Not listed to UL499. Vent-Sure is optional. Three-year Limited Warranty. Skidded Carton with foam-in-place packaging for Common Carrier

Voltage & Element Options

240 or 208, 1 phase only because of the way Kiln Sitter is wired no charge
 220 volts single phase (for non-USA installations) no charge
 Quad Element System (watts & amps do not change - elements doubled & more massive with Quad system) See above

Lid Option

Easy-Lift spring hinge option for D23S, D23S-3, D23T and D23T-3.....\$175

TRU-VIEW DIGITAL MULTI-ZONE PYROMETER SYSTEMS FOR MANUAL KILNS

Tru-View Digital Pyrometers



P1 Single Zone Digital Pyrometer with one 8 gauge thermocouple (T-G-PC00/00)	\$325
P2 Two Zone Digital Pyrometer with two 8 gauge thermocouples (T-G-P200/000)	\$415
P3 Three Zone Digital Pyrometer with three 8 gauge thermocouples (T-G-P300/00)	\$455
P4 Four Zone Digital Pyrometer with four 8 gauge thermocouples (T-G-P400/00)	\$500
P5 Five Zone Digital Pyrometer with five 8 gauge thermocouples (T-G-P500/00)	\$540
Pyrocoil metallic type K thermocouples instead of 8 ga type K TCs	\$25 each

Standard Features

A highly accurate digital pyrometer is mounted in an open control box. It is connected from one to five separate type K thermocouples with a selector switch. The pyrometer operates with one 9 volt battery. NOTE: All thermocouples should be the same thickness and of similar age. **More:** See hotkilns.com/Spec-Tru-View

LIBERTY-BELLE HOBBY KILNS WITH ONE-TOUCH™ CONTROL

Model No.	Kiln Price	Furn Kit	Quad Elem	No. of Shelves F=full, H=half	Brick Thick	Inside Diam	Inside Height	Cubic Feet	Exterior Dimensions	240V KW-Amp-Fuse	208V KW-Amp-Fuse	Ship Lbs	Lbs w/Kit
LB18	\$1525	\$210	\$250	15-1/2" (1F, 4H)	2-1/2"	17-1/2"	18"	2.6	29W x 31H x 30D	5.7~23.9~30	5.0~23.9~30	200	240
LB18-3	\$1575	\$210	\$250	15" (1F, 4H)	3"	16-1/2"	18"	2.5	29W x 32H x 30D	5.7~23.9~30	5.0~23.9~30	215	250

Furniture Kit: includes four each of 1", 2", 4" and 6" triangular posts plus one pound of Cone 10 kiln wash. You can substitute two half shelves for one full shelf at no charge. **Cone Rating:** Cone 10 **More:** See hotkilns.com/Spec-Liberty-Belle.pdf for additional information like shipping dimensions, electrical ratings, fuse sizes and wire connection sizes. Also see hotkilns.com/Spec-One-Touch.pdf for more information about the One-Touch™ control.



The perfect hobby kiln and great for people who need to stay portable. The 12 foot cord plugs into your dryer outlet!

Standard Features with the new One-Touch™ Intuitive Kiln Control

Proprietary One-Touch™ Intuitive Kiln Control. One touch and you are ready to fire the most common bisque and glaze programs. (also easy to adjust simple parameters like cone, delay, hold, heat-up and cool-down rates). You can even create four custom ramp/hold programs • 12 foot long cord with Nema 14-30 dryer type plug • Full support 14 gauge aluminized steel stand • Solid peephole plugs • Hard ceramic element holders • Proprietary reflective brick coating that protects brick and keeps dusting down • Mercury-free relays • c-MET-us listed to UL499 standards • Three-year Limited Warranty • Skidded Carton with foam-in-place packaging for Common Carrier

Voltage & Element Options

240, 220 or 208 single phase are all standard options at no charge. 3 phase is not available. Quad Element System (watts & amps do not change - elements doubled & more massive with Quad system)See above

Control Options

Pyrocil metallic thermocouple instead of 8 ga thermocouple\$25

Plug & Cord Options

Standard Nema 12 foot long 14-30 plug can be changed by customer to Nema 14-50 (hardware is included to do this). Nema 6-30 plug, Nema 15-50 or 6-50, Nema 10-30 or NEMA 10-50 plug is available for \$60 extra. A 6 foot long 6-50 plug is available at no charge. (All these plugs can be easily changed in the field if necessary.) All cords are 12 feet long.



Standard Standard No Charge \$60 \$60 \$60 \$60

DOLL / TEST KILNS WITH THREE CONTROL OPTIONS

Dimensions

Cubic Feet: 0.5 **Inside Diameter:** 11" **Inside Height:** 9" **Outside Width:** 19" **Outside Depth (front to back):** 23"

Standard Features of Manual Doll Kiln with Orton Kiln Sitter/Timer

Orton Kiln Sitter/Timer • Infinite manual switch • 120 volt operation • Power cord • Full support 14 gauge aluminized steel stand • Solid peephole plug • Hard ceramic element holders • Proprietary reflective brick coating that protects brick and keeps dusting down • Not UL499 listed • Three-year Limited Warranty • Skidded Carton with foam-in-place packaging for Common Carrier

Standard Features of Automatic Doll Kiln with the One-Touch™ Intuitive Kiln Control

Proprietary One-Touch™ Intuitive Kiln Control. One touch and you are ready to fire the most common bisque and glaze programs. (also easy to adjust simple parameters like cone, delay, hold, heat-up and cool-down rates). You can even create four custom ramp/hold programs • 120 volt operation (for all but the "DX" versions) • Type K 8 gauge thermocouple with ceramic protection tube • Full support 14 gauge aluminized steel stand • Solid peephole plug • Hard ceramic element holders • Proprietary reflective brick coating that protects brick and keeps dusting down • Not UL499 listed • Three-year Limited Warranty • Skidded Carton with foam-in-place packaging for Common Carrier

Standard Features of Automatic Doll Kiln with 24-Key DynaTrol Program Control

Same as the automatic with the One-Touch™ Program Control except it has the 24-Key DynaTrol (single zone version).



Perfection in a small package.

VENT-SURE DOWNDRAFT KILN VENT SYSTEM

Vent-Sure Super-Safe Downdraft Kiln Vent System

Vent-Sure Downdraft Kiln Vent System	\$440
Vent Doubler (includes all the parts necessary to vent two kilns up to 10 cubic feet each with one vent)	\$140
Bracket for mounting motor on floor or in vertical position on wall	\$25

The L&L Vent-Sure has the strongest fan motor in the industry - great for schools and other difficult installations.

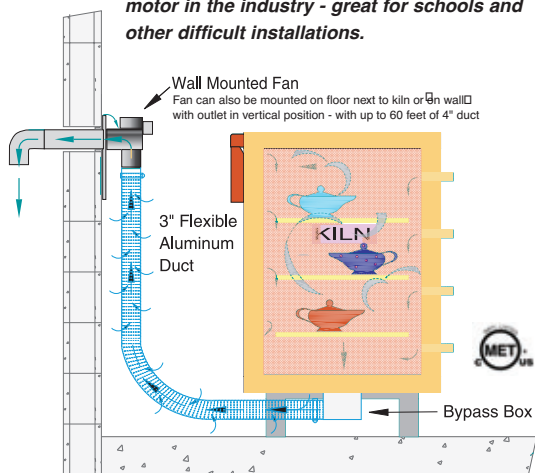

Standard Features

Downdraft venting pulls air down to bottom of kiln • Improves temperature uniformity inside the kiln • Powerful 130 CFM fan motor, typically mounted on wall, allows fumes to be under vacuum in your studio • 120 volts with on/off switch on cord 220-240 volt model available at no charge) • 15 foot long flexible aluminum duct • Bypass collection box mounted on kiln allows adjustment of venting. Note that, because of the air restrictions, the vent doesn't actually pull that much air out of the kiln - just enough • The strong fan motor helps overcome static pressure in long exhaust lines • Fan motor stays cool and there is no vibration transmitted to the kiln • Three-year Limited Warranty • c-MET-us Listed to UL499 standards for use on c-MET-us L&L Kilns (Easy-fire, Jupiter & Davinci). MET-us Listed to UL499 standards on Hercules, Easy-Load, Renaissance kilns. Not listed, Liberty-Belle, Dura-Fire and other brand kilns.

Which kilns you can use the Vent-Sure on?

Almost all L&L kilns will work with the L&L Vent-Sure power kiln vent system. The only exceptions are the Chameleon kilns listed in this Price List.

More information?

Specifications: See hotkilns.com/Spec-Vent-Sure
Instructions: See hotkilns.com/vent-sure-instructions

MISCELLANEOUS ACCESSORIES

Loading & Firing Accesories

Dark Viewing glasses. #3 shade (M-A-GLAS/00)	\$21
Cotton/Kevlar gloves will protect your hands from heat up to 300°F (M-A-GLOV/00)	\$21
1 lb box of Cone 10 Kiln wash (M-G-WASH/01)	\$4
5 lb Box of Cone 10 Kiln Wash (M-G-WASH/05).....	\$10

Books

What Every Potter Should Know (A 222 page book about firing ceramics) by Jeff Zamek. (B-G-WHAT/00).....	\$28
Electric Kiln Firing (A 284 page book about firing ceramics with electric kilns). By Richard Zakin. (B-G-ELCM/00).....	\$40
Mastering Cone 6 Glazes (A 168 page book about making and firing durable Cone 6 glazes) by John Hasselberth and Ron Roy. (B-G-CON6/00).....	\$40

Other

Brick Repair Kit (M-G-BKIT/00).....	\$35
-------------------------------------	------

DOLL / TEST KILNS WITH THREE CONTROL OPTIONS

Model No.	Kiln Price	Furn Kit	Control	Cone Rating	Watts	Amps	Volts	Fuse	Plug	Lbs Kiln	Lbs w/Kit
DL11	\$1050	\$145	Orton Sitter/Timer	5	1800	15	120	20	5-15R	110	130
DLH11	\$1050	\$145	Orton Sitter/Timer	10	2160	18	120	20	5-20R	110	130
DL11-DB	\$1050	\$145	One-Touch™ Control	5	1800	15	120	20	5-15R	110	130
DLH11-DB	\$1050	\$145	One-Touch™ Control	10	2160	18	120	20	5-20R	110	130
DLH11-DXB-240	\$1050	\$145	One-Touch™ Control	10	2800	11.7	240	15	14-30R	110	130
DLH11-DXB-208	\$1050	\$145	One-Touch™ Control	10	2800	13.5	208	20	14-30R	110	130
DL11-D	\$1175	\$145	24-Key DynaTrol Control	5	1800	15	120	20	5-15R	110	130
DLH11-D	\$1175	\$145	24-Key DynaTrol Control	10	2160	18	120	20	5-20R	110	130
DLH11-DX	\$1175	\$145	24-Key DynaTrol Control	10	2800	11.7	240	15	14-30R	110	130
DLH11-DX	\$1175	\$145	24-Key DynaTrol Control	10	2800	13.5	208	20	14-30R	110	130

Furniture Kit: includes two 9" diameter full shelves, one 9" diameter half shelf, four each of 1/2", 1", 1-1/2", 2", 2-1/2", 3" and 4" triangular posts plus one pound of Cone 10 kiln wash. You can substitute two half shelves for one full shelf at no charge. **Cone Rating:** See chart above. **More:** See hotkilns.com/Spec-Doll for additional information like shipping dimensions, electrical ratings, fuse sizes and wire connection sizes.

KILN SHELVES

SHELF MATERIAL AND RATING: All shelves that are 15" in diameter and above are currently made of a *press-molded (not cast) high alumina* cordierite body that holds up to Cone 11 firing with little warpage. This is particularly important for these larger shelves.

ROUND & POLYGONAL SHELVES

Shelves for 11 Diameter Kilns

For Doll/Test Kilns

Full Round 9" diameter shelf (7/16" thick) (H-D-9000/00)	\$25.00
Half Round 9" diameter shelf (7/16" thick) (H-D-9050/00)	\$15.00

Shelves for 14 Diameter Kilns

For J14 Kilns

Full Round 13" diameter (1/2" thick) (H-J-1300/00)	\$30.00
Half Round 13" diameter (1/2" thick) (H-J-1350/00)	\$18.00

Shelves for 16-1/2 Diameter Kilns

For LB18-3, e18S-3 & e18T-3, and J18-3 kilns with 3 brick

Full Round 15" diameter (5/8" thick) (H-J-150A/00)	\$37.00
Half Round 15" diameter (5/8" thick) (H-J-155A/00)	\$22.00

Shelves for 17-1/2 Diameter Kilns

For LB18, e18S & T, and J18 kilns with 2-1/2 brick

Full Octagonal 15-1/2" diameter (5/8" thick) (H-J-1500/00)	\$37.00
Half Octagonal 15-1/2" diameter (5/8" thick)(H-J-1550/00)	\$22.00

Shelves for 22 Diameter Kilns

For e23S-3, e23T-3, SM23T-3, & J2300-3 kilns with 3 brick

Full Round 20" diameter (3/4" thick) (H-J-2000/00)	\$73.00
Half Round 20" diameter (3/4" thick) (H-J-2050/00)	\$36.00

Shelves for 23 Diameter Kilns

For e23S, e23T, SM23T & J2300 kilns with 2-1/2 brick

Full Round 21" diameter (3/4" thick) (H-J-2100/00)	\$74.00
Half Round 21" diameter (3/4" thick) (H-J-2150/00)	\$37.00

Shelves for 28 & 29 Diameter Kilns

For e28S, e28T, SM28T, J2900 Series with 2-1/2 or 3 brick

Half Round 25-1/2" diameter (3/4" thick) (H-J-2650/00)	\$61.00
--	---------

SQUARE & RECTANGULAR SHELVES

Shelves for Small Front-Loading Kilns

For E48, E49, R490

6" x 8" rectangular (5/8" thick) (H-R-6800/00)	\$30.00
--	---------

Shelves for 17 Square Kilns

For SQ1818, SQ1827, X1800 Series, EL1824, EL3648

8" x 16" rectangular (5/8" thick) (H-S-1608/00)	\$32.00
16" x 16" square (3/4" thick) (H-S-1616/00)	\$61.00

Shelves for 22 Square Kilns

For X2300 Series

20" x 10" rectangular (5/8" thick) (H-X-2010/00)	\$44.00
--	---------

Shelves for 26 Square Kilns

For X2800 Series and X2800-XT Series kilns

23" x 11-1/2" rectangular (3/4" thick) (H-X-2311/00)	\$55.00
--	---------

Shelves for 26 x 35 Rectangular Kilns and 24 square Front-Loaders

For T2300 Series, T2300-XT Series, EL2424-H, EL2427-H, EL2436 & EL2448

22" x 11" rectangular (3/4" thick) (H-X-2211/00)	\$51.00
--	---------

Shelves for 30 x 28 Front Loader Kilns

For EL2848

24" x 14" rectangular (3/4" thick) (H-J-2414/00)	\$64.00
--	---------

Shelves for 30 Square, & 30 x 43 Rectangular Kilns

For X3200 Series, T3400 Series & EL3048

28" x 14" rectangular (3/4" thick) (H-J-2814/00)	\$70.00
--	---------

KILN POSTS

POST KITS

Large Square Post Kit (C-G-SPKT/EZ)	\$145.00
(Six each 1/2", 1", 2", 4", 6" & 8" square posts)	

Small Square Post Kit (C-G-SPKT/SM)	\$96.00
(Four each 1/2", 1", 2", 4", 6" & 8" square posts)	

Doll-Baby Post Kit (C-G-TPKT/DB)	\$60.00
(Four each of 1/2", 1", 1-1/2", 2", 2-1/2", 3" and 4" triangular posts)	

Liberty-Belle Post Kit (C-G-TPKT/LB)	\$41.00
(Four each 1", 2", 4" & 6" triangular posts)	

Large Triangular Post Kit (C-G-TPKT/O1)	\$118.00
(Six each 1/2", 1", 1-1/2", 2", 2-1/2", 3", 4", 5" & 6" triangular posts)	

Small Triangular Post Kit (C-G-TPKT/O0)	\$64.00
(Four each 1", 2", 3", 4", 5" & 6" triangular posts)	

FREIGHT FOR SHELVES AND FURNITURE KITS: Depending on the quantity and size of shelves, posts and furniture kit(s) ordered, the order may have to ship by common carrier freight. If so a skid/carton charge of \$35 will apply.

L&L sells the highest grade posts on the market. They are very straight (even in lengths up to 12" long), precision cut for squareness and are strong without being excessively thick.

TRIANGULAR POSTS (1" Triangular)

1/2"	Triangular Post (C-G-T005/00)	\$1.85
1"	Triangular Post (C-G-T010/00)	\$1.90
1-1/2"	Triangular Post (C-G-T015/00)	\$1.95
2"	Triangular Post (C-G-T020/00)	\$2.15
2-1/2"	Triangular Post (C-G-T025/00)	\$2.20
3"	Triangular Post (C-G-T030/00)	\$2.35
4"	Triangular Post (C-G-T040/00)	\$2.75
5"	Triangular Post (C-G-T050/00)	\$3.10
6"	Triangular Post (C-G-T060/00)	\$3.65
7"	Triangular Post (C-G-T070/00)	\$4.40
8"	Triangular Post (C-G-T080/00)	\$4.65
10"	Triangular Post (C-G-T100/00)	\$5.70
12"	Triangular Post (C-G-T120/00)	\$6.20

SQUARE POSTS (1-1/2" Square)

1/2"	Square Post (C-G-S005/00)	\$2.35
1"	Square Post (C-G-S010/00)	\$3.10
2"	Square Post (C-G-S020/00)	\$3.70
4"	Square Post (C-G-S040/00)	\$4.05
6"	Square Post (C-G-S060/00)	\$5.05
8"	Square Post (C-G-S080/00)	\$6.00
10"	Square Post (C-G-S100/00)	\$7.65
12"	Square Post (C-G-S120/00)	\$9.30