

# FUEGO INSTRUCTION MANUAL



L&L Kiln Mfg, Inc.

505 Sharptown Road, Swedesboro, NJ 08085

Ph: 856.294.0077 Fx: 856.294.0070 E: [service@hotkilns.com](mailto:service@hotkilns.com)

# CAUTION INSTRUCTIONS FOR L&L KILNS

<b>CAUTION INSTRUCTIONS</b> .....	1
KILNS THESE CAUTIONS APPLIES TO .....	1
RESELLERS ARE NOT AUTHORIZED TO MODIFY THESE CAUTION INSTRUCTIONS	1
DATED INFORMATION .....	1
SAFETY NOTICE .....	2
<b>ELECTRICAL SAFETY</b> .....	2
GENERAL .....	2
<b>ELECTRICAL HAZARDS</b> .....	2
SHOCK .....	2
ARC-FLASH .....	2
ARC-BLAST .....	2
<b>SAFETY PRINCIPLES</b> .....	2
<b>INSTALLATION CAUTIONS</b> .....	3
USE A QUALIFIED ELECTRICIAN .....	3
CLEARANCES AND FLAMMABLE SURFACES .....	3
CHECK TEMPERATURES AROUND KILN .....	3
LEVELING THE KILN .....	3
ADJUSTING THE HINGE PROPERLY .....	3
THERMOCOUPLES .....	4
USE THE SUPPLIED KILN STAND .....	4
DON'T USE AN EXTENSION CORD .....	4
POWER CORD MUST BE PROPERLY RATED .....	4
USE COPPER WIRE FOR HOOK UP .....	4
PROTECT POWER CORD FROM KILN CASE .....	4
KEEP KILN DRY & IN PROTECTED SPACE .....	5
KEEP A FIRE EXTINGUISHER NEAR KILN .....	5
SPRINKLER CAUTIONS .....	5
<b>GENERAL ENVIRONMENT CAUTIONS</b> .....	5
VENTILATION IS ESSENTIAL .....	5
AMBIENT TEMPERATURES .....	6
SURFACE IS HOT AND CAN CAUSE BURNS .....	6
KEEP CHILDREN/ANIMALS AWAY FROM KILN .....	6
KEEP FLAMMABLES AWAY FROM KILN .....	6
PRACTICE GOOD HYGIENE .....	6
PROPER USE OF KILN WASH .....	6
6. Clean off the old wash and reapply new wash each time you fire or when it begins to chip away. ....	6
TRIPPING HAZARDS .....	7
CLOTHING TO AVOID .....	7
<b>PREFIRING CAUTIONS</b> .....	7
KILN WASH CONTAINS SILICA .....	7
DO NOT USE SILICA SAND .....	7
NEVER FIRE MOIST GREENWARE .....	7
CAUTION WITH USE OF WAX .....	7
DO NOT FIRE TEMPERED GLASS .....	7
STORE SHELVES IN A DRY LOCATION .....	7
DO NOT USE CRACKED SHELVES .....	7
DO NOT FIRE TOXIC, FLAMMABLE, OR UNKNOWN MATERIALS .....	7
<b>LOADING &amp; UNLOADING CAUTIONS</b> .....	8
TURN OFF POWER WHILE LOADING .....	8
KEEP LID CLOSED WHEN KILN IS NOT IN USE .....	8
DO NOT STORE ANYTHING ON LID .....	8
DO NOT OPEN THE DOOR ABOVE 250° F .....	8
DO NOT UNLOAD KILN WHILE HOT .....	9
BE CAREFUL OF SHARP OBJECTS & GLAZE .....	9
SECURE LID WHILE LOADING OR UNLOADING IF YOU HAVE A SPRING-LOADED EASY-LIFT HINGE .....	9
IF YOU HAVE A DAVINCI COUNTERBALANCED LID .....	9
IF YOU HAVE A BASIC HINGE WITH CHAIN SUPPORTS .....	9
VIEWING INTO THE KILN .....	9
<b>FIRING CAUTIONS</b> .....	10
ATTEND THE FIRING .....	10
MAKE SURE YOUR KILN SITTER IS ADJUSTED .....	10
USE KILN WASH ON THE CONE SUPPORTS .....	10
UNDERSTAND YOUR CONTROL .....	10
PROGRAM REVIEW ON AUTOMATIC KILNS .....	10
DO NOT CONFUSE CONE NUMBERS .....	10
USE THE PROPER THERMOCOUPLE .....	10
CHECK THERMOCOUPLE CALIBRATION .....	11
SHUT OFF KILN AT DISCONNECT OR CIRCUIT BREAKER .....	11
DO NOT FIRE KILN ABOVE 2350° F (1290° C, Cone 10) .....	11
<b>POST FIRING CAUTIONS</b> .....	11
CHECK FOR GLAZE AND CERAMIC CHIPS .....	11
<b>GENERAL MAINTENANCE CAUTIONS</b> .....	12
ELECTRICAL SAFETY .....	12
CHECK WIRES & TERMINALS .....	12
CHECK TEMPERATURE OF CORD .....	12
CHECK FOR CORRODED CONNECTIONS .....	12
THE WRONG PARTS CAN BE HAZARDOUS .....	12
VIDEO ABOUT GENERAL MAINTENANCE .....	12
<b>KILN MODIFICATIONS CAUTIONS</b> .....	13
COATINGS .....	13
OTHER MODIFICATIONS .....	13
DO NOT OVERINSULATE KILN .....	13

## CAUTION INSTRUCTIONS

### KILNS THESE CAUTIONS APPLIES TO CURRENT PRODUCTION KILNS

- Easy-Fire Kilns (e Series)
- School-Master Kilns (SM Series)
- Easy-Fire XT Kilns (eXT Series)
- Jupiter Automatic Kilns (JD Series)
- eQuad-Pro Production Kilns (eQ Series)
- JH Crystalline Kilns (JH Series)
- Hercules Front-Loading Kilns (EL-H Series)
- Easy-Load Front-Loading Kilns (EL Series)
- DaVinci Automatic Kilns (X and T Series)
- Doll/Test Kilns (DL and DLH Series)
- Liberty-Belle Kilns (LB Series)
- Fuego Kilns

### OBsolete Models

- Jupiter Manual Kilns (J Series)
- Econo Kilns (K Series and J Series)
- Programmatic Kilns (B Series)
- Robin Kilns
- Dyna-Kilns (C & H Series)
- Dyna-Kilns (SQ Series)
- Dura-Fire Kilns (D Series)
- Enameling Kilns (E48, E49, R Series)
- Oval Kilns (OV Series)
- Genesis Kilns (G Series)
- Most other L&L kilns

### RESELLERS ARE NOT AUTHORIZED TO MODIFY THESE CAUTION INSTRUCTIONS

Distributors and installers of L&L kilns are not authorized by L&L to make modifications or contradict these Caution Instructions (or our Installation Instructions). If L&L's instructions are not followed, L&L specifically disavows responsibility for any injury or damage that may result.

### DATED INFORMATION

The information in these Caution Instructions is believed to be correct to the best of our knowledge at the time of publication (see the date at the bottom of this sheet). You can view the most recent update from our web site at [hotkilns.com/cautions](http://hotkilns.com/cautions) at any time.

# CAUTION INSTRUCTIONS FOR L&L KILNS

## SAFETY NOTICE

1. All cautions and requirements recommended by L&L Kiln Mfg. Inc. are meant to assist users to properly and safely operate their kilns. Many of these cautions apply to kilns and ceramic processes in general. Other process and materials are outside the scope of these Cautions. If you are firing other materials than ceramics there may be issues such as outgassing or explosive hazards that you need to carefully investigate before firing in a kiln.
2. By making use of, and/or downloading from, this web site, user acknowledges that process and manufacturing systems improperly installed, maintained, or operated can pose serious and dangerous threats to worker safety, environmental integrity, and product/process quality.
3. Kilns operate at high temperatures and make use of high voltages/amperages and if improperly installed, maintained, or used, can cause serious personal or property damages.
4. Commercial kilns are provided with various safety, performance, and operating limits, designs and devices which, if disconnected, altered, tampered with, or changed by user, user's employees, user's agents, or others acting on user's behalf or with user's knowledge, will become user's sole risk and responsibility.
5. User also has the sole responsibility for assigning properly trained persons to operate the kilns who have demonstrated common sense and a general aptitude for such work.
6. It is user's sole responsibility to understand and assure adherence to all safety notices and installation, operating, and maintenance instructions provided by L&L Kiln Mfg., Inc.

## ELECTRICAL SAFETY

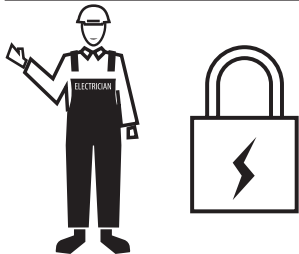

### GENERAL

Electricity can be dangerous if not approached carefully. There are three basic hazards that cause injury or death – shock, arc-flash, and arc-blast. It is important to remember that even a small amount of current passing through the chest can cause death. Most deaths occurring for circuits

of less than 600 volts happen when people are working on “hot,” energized equipment – **PLEASE DISCONNECT AND LOCK OUT ALL ELECTRICAL POWER BEFORE ATTEMPTING KILN REPAIRS!**

## ELECTRICAL HAZARDS

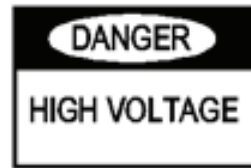

### SHOCK

An electrical shock is a current that passes through the human body. Any electrical current flows through the path of least resistance towards ground; if an external voltage contacts a human body, e.g. by touching a live wire with the hand, the voltage will try to find a ground, and a current will develop that flows through the body's nervous system or vascular system, and exit through the closest part of the body to ground (e.g., the other hand which may be touching a metal pipe.) Nerve shock disrupts the body's normal electrical functions, and can stop the heart or the lungs, or both, causing severe injury or death.

### ARC-FLASH

An arc-flash is an extremely high temperature conductive mixture of plasma and gases, which causes very serious burns when it comes into contact with the body, and can ignite flammable clothing. Arc temperatures reach up to 35,000°F – which is 4X the temperature of the sun's surface.

### ARC-BLAST

Arc-blast is a pressure wave resulting from arcing, which can carry molten metal fragments and plasma gasses at very high speeds and distances. This can not only carry very hot shrapnel to injure a person, but can actually be strong enough to destroy structures or knock workers off ladders.

## SAFETY PRINCIPLES

Be safe! Make sure any equipment that is being installed or serviced is disconnected from all sources of power. In industry, it is important to have 'Lockout and tagout' procedures in place to make sure that power stays disconnected while people are servicing equipment. It is just as important in residential and commercial sites – DO NOT

# CAUTION INSTRUCTIONS FOR L&L KILNS

WORK ON LIVE EQUIPMENT UNLESS ABSOLUTELY NECESSARY!

Use the right tools for the job – do not improvise. For instance, use a proper fuse puller; don't use a screwdriver to pry out an open fuse.

Protect the person; use proper gloves, shoes, and clothing. In industry it is recommended to wear safety goggles or face shields to prevent arc-flash or arc-blast injuries. Wear rubber soled shoes.

Make sure the environment around the equipment being serviced is safe. For instance, when working around electricity, **it always very dangerous for the floor to be wet**. Make sure there is adequate space to work safely.

Be aware that current flow across your chest can be fatal. If possible, use only one hand to manipulate test leads when conducting any necessary measurements on live equipment. Use a clamp for one lead, and use one hand to guide the other test lead. Keep the other hand as far as possible from the live circuit components.

## INSTALLATION CAUTIONS

### USE A QUALIFIED ELECTRICIAN

1. Have electrical installation performed by an licensed electrician or other qualified technician.
2. There is danger of electric shock.
3. There is danger that an improperly sized or installed circuit could cause a fire.

### CLEARANCES AND FLAMMABLE SURFACES



1. Make certain floor is not flammable.
2. Install kiln so that the hot surface of the kiln is no closer than 12" (30 cm) to any wall. 18" (46 cm) is preferable.
3. Be careful about enclosed spaces: In general, it is not a good idea to install a kiln in a small confined space (such as a closet).
4. Maintain a minimum of 36" (91 cm) between the hot surfaces of two adjacent kilns, especially if they are going to be used at the same time. (The kilns will heat each other).

5. The essential issue with kiln clearance is to keep excessive heat from flammable surfaces. Remember, even when you follow clearance and ventilation recommendations, the kiln is giving off heat. Try not to place the kiln near things that can be affected by elevated temperatures. An example would be an electrical fuse panel which you do not want to overheat.

### CHECK TEMPERATURES AROUND KILN

1. Check temperatures around the kiln when it is at high fire to be sure that you are not creating an unsafe condition.
2. Combustible surfaces that stay below 71°C (160°F) are generally considered safe from the point of view of starting a fire.

### LEVELING THE KILN

1. Level the kiln while you are installing it.
2. Use thin metal shims under the legs to accomplish the leveling (never wood or other combustible materials).
3. Make sure that the base will not wobble.
4. Leveling is important because the kiln sitter (in older manual kilns) is affected by gravity. If the kiln is not properly leveled the kiln sitter might be either too reactive or too sluggish.
5. You do not want your ware to be unstable in the kiln. It might fall over.
6. If kiln is not leveled this could lead to the cracking of the bottom and the top. In particular, the bottom could easily crack when you first set the weight of the kiln on the bottom while setting up the kiln for the first time.

### ADJUSTING THE HINGE PROPERLY

1. See the assembly instructions for your specific kiln. (Assembly instructions are available at [hotkilns.com/assembly-instructions](http://hotkilns.com/assembly-instructions))
2. **CAUTION: DO NOT attempt to disengage the spring hinge without first reading the detailed assembly instructions.** The spring is under great pressure and could cause severe injury if it is removed under pressure. **RELIEVE ALL SPRING TENSION BEFORE REMOVING! OPEN LID COMPLETELY!**
3. The hinge of any kiln must be adjusted so that expansion caused by the heating process has room to expand up and down. (L&L includes expansion slots in the hinges.)
4. An improperly adjusted hinge can damage the top kiln rim and/or lid by compressing and breaking the brick near the hinge.



# CAUTION INSTRUCTIONS FOR L&L KILNS

5. CAUTION: It is critical that the hinge bar sits in the bottom of slot. This is to allow the lid to rise and fall slightly as the kiln heats and expands without putting stress on the lids connection points and potentially damaging the lid.

## IMPORTANT CAUTION:

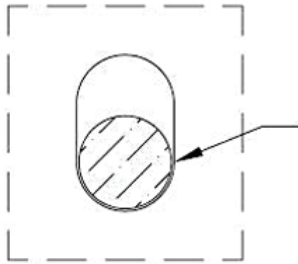

Loosen the screws and adjust the hinge bracket so that the lid lays flat on the top ring and the middle rod rests on the bottom of the elongated holes in the bracket. (As Shown)

## THERMOCOUPLES

1. Thermocouples (in automatic kilns) must be inserted into the kiln at least 1" (2.5 cm) in from the inside surface of the kiln.
2. They must protrude into the kiln itself because, if the measuring tip of the thermocouple is buried inside the insulation, the thermocouple will measure a lower temperature than the actual temperature in the kiln.
3. This could cause an overfire of the kiln.
4. Replace thermocouples once they are no longer reasonably accurate. (Note: Type K thermocouples last about the same as kiln elements so it is recommended to change thermocouples when you change elements.)

## USE THE SUPPLIED KILN STAND

1. Do not use kiln without the factory supplied stand.
2. Never set a kiln on a floor without significant air space circulating under the kiln.
3. L&L stands typically raise the floor of the kiln by 8" (20 cm).
4. Using a proper stand is critical because, without a kiln stand that moves the radiant heat of the kiln away from the floor, some flooring could catch on fire. For instance, over time the radiant heat from the kiln can cause wood to lose its moisture and lower the autoignition temperature. (The autoignition temperature is the specific temperature at which a substance ignites and causes a fire.)

## DON'T USE AN EXTENSION CORD

1. Never use an extension cord with your kiln. The extra length of the wire could cause the cord to overheat and catch on fire.
2. Extension cords, with their multiple connections and potentially mismatched wire gauge for the load, could cause a fire when used with a continuous resistive load like a kiln.
3. Locate the outlet close enough to the kiln to plug directly into it with the kiln's supplied power cord.
4. Kilns that pull over 48 amps and some three phase kilns generally will not have a power cord. These kilns need to be direct-wired in to the power supply.

## POWER CORD MUST BE PROPERLY RATED

1. All L&L power cords are rated for 105°C (221°F).
2. Any cord temperature rating less than 105°C can cause a malfunction and possible fire where the power leads connect to the control box.
3. It is OK, and will not void the warranty, to remove the plug that comes with the kiln and direct wire the kiln. However, the connection wires must be rated for a minimum of 105°C (221°F).

## USE COPPER WIRE FOR HOOK UP

1. Do not use aluminum wire on the final connection to the kiln.
2. The specific reason particular to kilns is that the wire tends to get hotter near the kiln than it might going into some other types of appliance.
3. Being a resistive load, there is constant heat being generated by the conductors for quite a few hours. When aluminum wire gets hot it accelerates oxidation. Aluminum oxide is a resistor; copper oxide is not as much. If the connection at the terminal board gets oxidized it will really heat up - to the point where it could cause a fire.
4. Note: Depending on local codes it may be OK to use aluminum wire to your subpanel - as long as that wire is not exceeding its temperature rating while kiln is firing on full power for an extended period of time.

## PROTECT POWER CORD FROM KILN CASE

1. Route Power Cord (or electrical connection wires) away from kiln in such a way that the wires can not touch the hot case of the kiln.
2. Secure the cord so it can not move.

# CAUTION INSTRUCTIONS FOR L&L KILNS

3. If the cord touches the hot case it could melt and cause a short circuit and/or fire.

## KEEP KILN DRY & IN PROTECTED SPACE

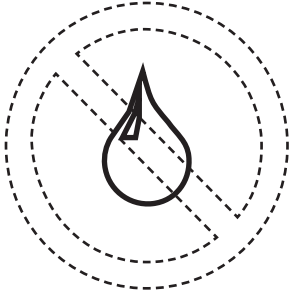

1. The kiln must be kept dry.
2. It is best to keep it in an enclosed room away from inclement weather. See specific details in the INSTALLATION INSTRUCTION section of your instruction manual or on-line at: [hotkilns.com/easy-school-install](http://hotkilns.com/easy-school-install) or: [hotkilns.com/general-installation-instructions](http://hotkilns.com/general-installation-instructions).
3. Note that warranty does not cover damage from corrosion and electrical damage caused by inclement weather.
4. Water in contact with a kiln can cause an electrocution hazard.
5. If you keep a kiln outside (even in a very dry environment) and cover it with a tarp to protect it from rain you could still cause corrosion from the dew that forms on the cold metal surface of the kiln in the morning.

## KEEP A FIRE EXTINGUISHER NEAR KILN

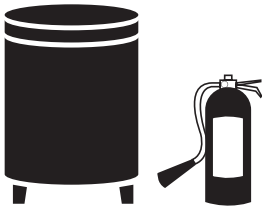

1. Keep an adequate fire extinguisher near the kiln and check it on a regular basis.
2. Check with your local fire authorities to see if there are any specific requirements concerning sprinkler systems, automatic foam extinguishers, etc.
3. Use a fire extinguisher that is rated for electrical fires (ABC rating is recommended).

## SPRINKLER CAUTIONS

1. If you have a sprinkler system be careful to check the temperature rating and location of the heads so that you do not inadvertently cause them to actuate under normal firing conditions.



2. Be sure to monitor temperature while the kiln is at its highest firing temperature and conditions are at their worse (for instance when the door to the kiln room is closed or the ventilation fan is turned off). **Serious damage to the kiln and your premises can take place if the sprinkler system goes off when the kiln is at high temperature** - especially if no one is in the building when it happens.
3. See the following web page for guidance on how to calculate ventilation requirements for a kiln room: [hotkilns.com/calculate-kiln-room-ventilation](http://hotkilns.com/calculate-kiln-room-ventilation)

## GENERAL ENVIRONMENT CAUTIONS

### VENTILATION IS ESSENTIAL

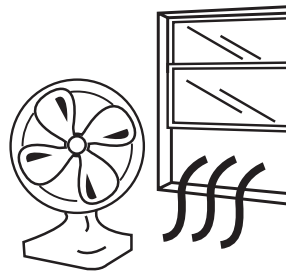

1. Kilns generate harmful fumes when firing ceramics.
2. Fumes include carbon monoxide, sulfur oxides, hydrogen fluoride and metal vapors (all of which can be very toxic).
3. Install kiln in well-ventilated area.
4. Never operate in an enclosed space such as a closet unless you have good ventilation in that space. See the following web page for guidance on how to

# CAUTION INSTRUCTIONS FOR L&L KILNS

calculate ventilation requirements for a kiln room:  
[hotkilns.com/calculate-kiln-room-ventilation](http://hotkilns.com/calculate-kiln-room-ventilation)

5. Aside from issues of ventilating the fumes from the firing, the heat build up in an enclosed room could present a significant fire hazard. See the INSTALLATION cautions.
6. Severe corrosion can be caused by kiln fumes, salt air or other environmental conditions.
7. Good venting can minimize these problems.
8. Ventilation must be to the outside.
9. Be careful not to locate the outlet of the vent near an open window.

## AMBIENT TEMPERATURES

1. The kiln should operate in an environment that is between -18°C (0°F) and 38°C (100°F).
2. Note that the control, if set up for degrees centigrade, may give you an error code if room temperature drops below 0°C (32°F). The DynaTrol and most other controls do not handle negative numbers.

## SURFACE IS HOT AND CAN CAUSE BURNS



1. Kiln surface can be extremely hot: up to 260°C (500°F).
2. You can be severely burned if you touch the hot surface.
3. Display a sign near the kiln that specifically warns everyone of how hot the kiln is.

## KEEP CHILDREN/ANIMALS AWAY FROM KILN

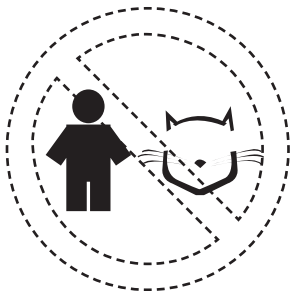

1. Protect any children, animals, and unqualified adults (anyone who is not able to understand these cautions) that may be near the kiln.

2. Aside from fumes that must be ventilated, and flammability concerns, they must be protected from the heat of the kiln and the electrical dangers.

3. Ideally, the kiln should be secured in a space away from any children (especially in a schoolroom situation where children might not always follow safety precautions).

## KEEP FLAMMABLES AWAY FROM KILN



1. Do not put sealed containers or combustible materials such as solvents, paper, rags, kerosene, paints, cesium, magnesium, aluminum powder, calcium, sawdust, plastic dust, coal, flour and powdered metal., in or near kiln. An explosion or fire could result.

2. The kiln elements could act as an ignitor of flammable fumes when hot.

## PRACTICE GOOD HYGIENE

1. Clay contains silica dust which can be harmful (see silica caution) and some glazes contain heavy metals such as lead, cadmium and copper.

2. While this caution is outside the scope of kiln safety it is worth mentioning here.

3. Keep your room clean and your kiln clean.

## PROPER USE OF KILN WASH

1. Make sure the floor of the kiln and the tops of the shelves are coated with kiln wash.

2. This will protect these surfaces from melting glaze and ceramics.

3. Do not coat the undersides or sides of the shelves.

4. Do not apply kiln wash to the brick sides or element holders. (Damage to the elements could result).

5. If you have a kiln sitter, put kiln wash on the cone supports (not the sensing rod) for accurate cone action.

6. Clean off the old wash and reapply new wash each time you fire or when it begins to chip away.

# CAUTION INSTRUCTIONS FOR L&L KILNS

## TRIPPING HAZARDS

1. Be sure to remove tripping hazards near the kiln.
2. In particular be sure to keep the kiln cord out of traffic areas.

## CLOTHING TO AVOID

1. When working around a hot kiln be careful of the kinds of clothes you are wearing.
2. Some clothes could potentially catch on fire if they touch the hot surface of a kiln.
3. Also avoid loose fitting clothes that could catch on the kiln.

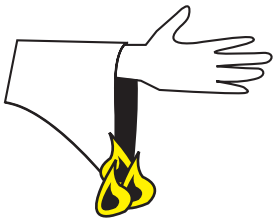

## PREFIRING CAUTIONS

### KILN WASH CONTAINS SILICA

1. Long term exposure to silica dust could cause lung damage.
2. See the MSDS sheets in your instruction manual or here: [hotkilns.com/msds](http://hotkilns.com/msds).
3. Exercise proper caution when mixing the dry powder and when removing it from your shelves.
4. Use a NIOSH approved particulate respirator for dust and use proper ventilation. You can buy these from safety supply houses. (NIOSH\_approval #TC-21C-132 is an example).

### DO NOT USE SILICA SAND

1. Do not use silica sand in the kiln.
2. Some people like to use this as a work support medium.
3. The silica sand will attack the elements and thermocouples.
4. It can migrate in the kiln from expansion and movement due to heat.
5. If you must use sand to support or stabilize your load try alumina oxide or zirconia oxide sand.

### NEVER FIRE MOIST GREENWARE

1. Never load moist greenware or pots in your kiln.
2. The expanding water vapor in the ware could cause the ware to explode, damaging your kiln interior.

3. We recommend using a dry out segment in your bisque program at 66°C (150°F). (Note that, because of the thermocouple offset programmed into our DynaTrol when we use the ceramic protection tubes, the display temperature will read 93°C (200°F) when the real temperature is 66°C (150°F)).

4. Remember that there may be water trapped in the work even if you can't always see it. If you place a piece of greenware next to your wrist and it feels cool to the touch it probably has too much moisture in it to fire.

### CAUTION WITH USE OF WAX

1. When you heat wax (in wax resist and lost wax processes) it will volatilize and potentially condense in the cooler ventilation ducts.
2. Over time this can cause a fire hazard because the wax is flammable.
3. Depending on how the vent motor is mounted, the wax can also gum up the vent motor.
4. If you use these processes it is entirely up to you to engineer and monitor the safety of the installation.
5. The use of wax will void the warranty of the vent system.

### DO NOT FIRE TEMPERED GLASS

1. Tempered glass can explode when fired.

### STORE SHELVES IN A DRY LOCATION

1. Shelves can absorb moisture.
2. This can cause them to explode when fired. (This is especially true of nitride bonded silicon carbide shelves).

### DO NOT USE CRACKED SHELVES

1. Cracked shelves can fail in the middle of a firing causing the whole load in your kiln to collapse.

### DO NOT FIRE TOXIC, FLAMMABLE, OR UNKNOWN MATERIALS

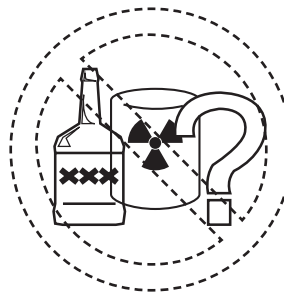



# CAUTION INSTRUCTIONS FOR L&L KILNS

1. Plastics, organic materials, bakeable modeling clay, mothballs and a large variety of materials can decompose under heat causing the release of highly toxic fumes or rapid uncontrollable combustion.
2. Rocks, marbles, cement and other materials may explode under high temperatures.
3. Before firing anything but ceramics, glass and metal (obtained from a known reputable source) in a kiln carefully investigate what happens under heat.
4. This is the sole responsibility of the user.
5. The kiln is not designed to be used for firing hazardous materials. Doing so will void kiln warranty.
6. Adding propane, wood, charcoal or other materials intended to produce a reduction atmosphere can be hazardous if the volume is sufficient. Note that these materials can cause an explosion under certain conditions (just the right amount of air and flammable gasses at just the right temperature) which could cause injury or death. Moreover, a reducing atmosphere can cause premature element failure by reducing the protective oxide coating on the elements. Also note that carbonaceous materials will produce poisonous carbon monoxide and highly flammable hydrogen as they decompose at high temperatures. Also note that the "auto-ignition" temperature of flammable gasses is generally above 1400° F.

## LOADING & UNLOADING CAUTIONS

### TURN OFF POWER WHILE LOADING



1. Turn off power to the kiln when loading or servicing.
2. If power is on when you are loading or unloading the kiln it is possible to touch the elements and get electrocuted.
3. We recommend having the kiln attached to a fused disconnect switch with a lockout device (in any institutional or industrial installations where someone could turn on the kiln while someone else was working on it).

### KEEP LID CLOSED WHEN KILN IS NOT IN USE

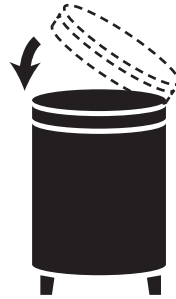

1. Keep lid closed when not operating the kiln.
2. Otherwise the weight of the lid over time may force the hinge and stainless wrap to move down.
3. This will affect the way the lid closes and may cause the lid to crack.
4. It will also keep the kiln cleaner by keeping dust out.
5. In addition, if the kiln somehow gets turned on accidentally, an open kiln could present a fire hazard.

### DO NOT STORE ANYTHING ON LID

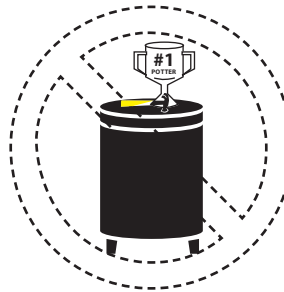

1. Do not use the lid as a storage shelf.
2. The lid could crack.
3. Also - this practice could lead to a fire if you accidentally leave combustible materials on the lid.

### DO NOT OPEN THE DOOR ABOVE 250°F

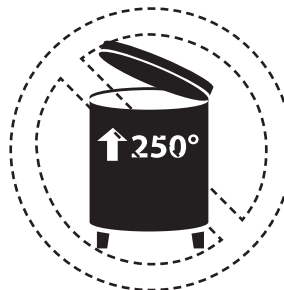

# CAUTION INSTRUCTIONS FOR L&L KILNS

1. Do not open the kiln door until the kiln has cooled down to 250°F (120°C).
2. You could burn your hand on the handle and/or the radiant heat from the kiln.
3. Be careful when you do open the door at this temperature because you can still get burned.
4. Use heat resistant gloves when opening the door. (These are available from L&L).
5. For ventilation purposes, some people fire with the lid slightly propped open 1" to 3" during the beginning phase of the firing (if they do not have a downdraft vent system). **Be aware of the potential dangers of doing this (heat, live electricity, fumes and potentially cracking the lid) and take appropriate measures to protect yourself, the kiln, and the kiln room.**

## DO NOT UNLOAD KILN WHILE HOT

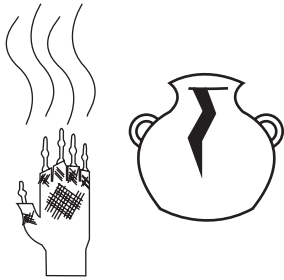

1. You may burn yourself
2. You may harm your work.

## BE CAREFUL OF SHARP OBJECTS & GLAZE

1. Stilt marks and other sharp protrusions can cut you.
2. Remember that glaze is like glass.
3. Wear safety glasses while grinding or knocking of stilt marks.
4. Check the shelves for broken bits of glaze which may have attached to the shelves. These can be like shards of glass that can cause a serious cut.

## SECURE LID WHILE LOADING OR UNLOADING IF YOU HAVE A SPRING-LOADED EASY-LIFT HINGE

1. Be sure to LOCK THE LID IN PLACE with the spring-loaded plunger pin located on the side of the hinge.

## IF YOU HAVE A DAVINCI COUNTERBALANCED LID

1. Be sure to LOCK THE LID IN PLACE with the safety hooks when in the up position.
2. There is one on each side of a DaVinci kiln. Use both chains.

## IF YOU HAVE A BASIC HINGE WITH CHAIN SUPPORTS

1. A special safety system is supplied with your Fuego, Liberty-Belle, e18S, e18T, J18, or J18X kiln (and some other older models). This is a door safety chain.
2. It secures the lid in an open position when you are loading or unloading the kiln and ensures that the lid can not accidentally come down on you. You must install and use this for your safety's sake.

*This drawing shows the safety chain installation and use for the standard older Jupiter hinges.*

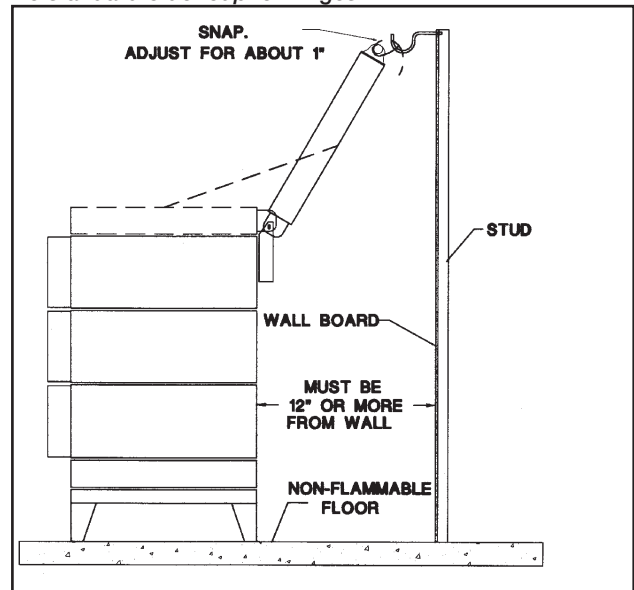

## VIEWING INTO THE KILN

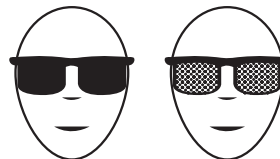

1. Use dark glasses (shade number 1.7 to 3.0) to view inside the kiln through the peepholes when firing. These will protect you from the radiant infrared radiation and will also protect your eyes in case the ceramic ware explodes. Do

# CAUTION INSTRUCTIONS FOR L&L KILNS

not use regular sunglasses for this - they are not designed to protect your eyes from this type of radiation.

2. Use heat resistant gloves when opening peephole plugs. They are very hot and can burn you.
3. Do not open the kiln lid unless the kiln is turned off (except for carefully controlled troubleshooting tests). There is danger from electrocution. Cracks caused by propping open the lid are not covered by the warranty.
4. Use heat resistant gloves when opening a hot lid.
5. Do not open the lid when the kiln is above 121°C (250°F).

## FIRING CAUTIONS

### ATTEND THE FIRING

1. We recommend attending the kiln while firing.
2. **NO AUTOMATIC SAFETY DEVICE IS FOOLPROOF!** Be especially careful about attending the kiln when it is supposed to shut off. (The Delay feature in automatic kilns gives you control over this).
3. If you have a manual kiln with a Kiln Sitter PLEASE BE EXTRA CAREFUL! Kiln sitters can be very unreliable because of the moving parts, dirt or clay that can get into the tube, the way cones are placed on the tube, corrosion, etc. **DO NOT FIRE THIS KILN UNATTENDED WHEN THE KILN IS SUPPOSED TO TURN OFF AND LEARN HOW TO USE THE TIMER BACK UP.** Neither L&L Kiln Mfg., Inc. nor Edward Orton Jr. Ceramic Foundation warranty the kiln or kiln sitter against damage caused by overfiring. ***ALMOST ALL OVERFIRED KILNS WE SEE ARE FROM A MALFUNCTION OF A KILN SITTEER. We highly recommend firing all manual kilns with witness cones that you can see through the peephole and/or a pyrometer so you have some idea of what is happening inside the kiln.***
4. The controller is used to control temperature; it is not a safety device.

### MAKE SURE YOUR KILN SITTEER IS ADJUSTED

1. If you have a manual kiln (or the Kiln Sitter backup on an automatic kiln) be sure it is properly adjusted.
2. See the Kiln Sitter instructions.
3. Overfiring could result.
4. Note that the kiln sitter could have gone out of adjustment during shipment. Do NOT assume that it is adjusted when first firing the kiln.

5. The tube assembly should be replaced if gets overly corroded or contaminated with condensed glaze or other materials. Dawson recommended checking the pivot point for corrosion and sluggishness every 6 to 12 months.

### USE KILN WASH ON THE CONE SUPPORTS

1. If you have a kiln sitter, put kiln wash on the cone support (but not the sensing rod) for accurate cone action.
2. This will keep the cones from sticking when they bend.
3. We recommend cleaning off the old wash and reapply new wash each time you fire.

### UNDERSTAND YOUR CONTROL

1. Become familiar with either the control (if you have an automatic kiln) or the Kiln Sitter (if you have a manual control or have that as your backup control).
2. Do this before operating the kiln.

### PROGRAM REVIEW ON AUTOMATIC KILNS

1. Review the current program before firing to ensure the correct profile is programmed.
2. You may pick up an important mistake and save a whole load.
3. Hit **Review Prog** after you have done your programming and the control display will scroll through the program. It only takes a minute or less.

### DO NOT CONFUSE CONE NUMBERS

1. Cone ratings are not intuitive. Cones with an "0" in front of them (like cone 05) are lower in temperature rating and the higher the number the lower the temperature rating. On the other hand cones with no "0" in front (like Cone 5) raise in temperature as the number gets higher.
2. For instance, Cone 05 is a much lower temperature than Cone 5 for instance. If you fire Cone 05 clay to Cone 5 you could cause a serious overfiring of the material which could melt in your kiln and cause severe damage to the kiln interior.
3. See the Orton cone chart. ([hotkilns.com/orton-cone-chart](http://hotkilns.com/orton-cone-chart))

### USE THE PROPER THERMOCOUPLE

1. Never use a different type of thermocouple with your controller unless it has been set up from the factory (or unless you carefully go through the process of changing from one type to another).

# CAUTION INSTRUCTIONS FOR L&L KILNS

2. For instance if you used a Type S thermocouple on a control set up for Type K you would overfire your kiln.
3. On some controls (like the newer DynaTrols) it is possible to change thermocouple types. However, this involves both a programming change and a jumper change on the control. It also requires you to change out all the thermocouple lead wire to properly calibrated wire for the new thermocouple type. (See: [hotkilns.com/change-thermocouple-type](http://hotkilns.com/change-thermocouple-type))

## CHECK THERMOCOUPLE CALIBRATION

1. Thermocouples will drift in reading over time.
2. This could potentially lead to an overfiring before the thermocouple actually fails.
3. Although you can not easily check thermocouple calibration, the general accuracy of the entire kiln system can be checked by firing with witness cones. See the LOG, CONES & CERAMIC FIRING section or [hotkilns.com/troubleshooting-cones](http://hotkilns.com/troubleshooting-cones). Also see this video: [hotkilns.com/firing-kiln-witness-cones](http://hotkilns.com/firing-kiln-witness-cones).
4. **L&L recommends changing your Type K thermocouples when you change your elements.**

## SHUT OFF KILN AT DISCONNECT OR CIRCUIT BREAKER

1. It is possible for electrical contacts on contactor relays to fuse together.
2. If this happens power will continue to flow to the elements and your kilns could overfire even though everything on the kiln is shut off.
3. You should turn kiln off from the circuit breaker or fused disconnect switch after turning off the kiln itself.

## DO NOT FIRE KILN ABOVE 2350°F (1290°C, Cone 10)

1. Most L&L kilns are rated for use to 2350°F (1290°C, Cone 10).
2. The rating of the kiln is listed on its data nameplate normally affixed to the control panel.
3. **DO NOT FIRE ANY HIGHER THAN THIS** or hold for extended periods of time at those temperatures.
4. The elements, element holders and firebrick could melt.

## POST FIRING CAUTIONS

---

### CHECK FOR GLAZE AND CERAMIC CHIPS

1. Check element holders and walls for glaze, clay chips or anything that could melt at a high temperature.
2. If melted clay or glaze comes in contact with an element, a rapid failure could result. The molten material traps the heat radiating from the element and subsequently raises the surface temperature of the wire. The temperature will quickly pass the maximum recommended temperature for the wire and burn it.
3. To clean holders, a good shop vacuum **with a HEPA filter** will handle dust and loose crumbs. A very gentle chisel or grinder may help with glaze contamination on element holders, but remember that the elements themselves are quite brittle when they are cool.

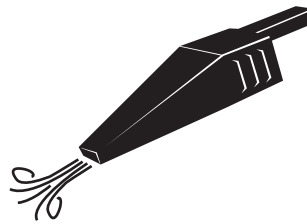

4. Replace the contaminated holder if you can not clean it.
5. Remove any glaze that has splattered on the firebrick or shelves. **(USE SAFETY GLASSES WHEN DOING THIS BECAUSE GLAZE CAN BE LIKE BROKEN GLASS).** Vacuum afterward. Note about vacuuming: it is possible to build up a strong static electricity charge when you are vacuuming. If this somehow manages to discharge into the control it can ruin the electronic circuit. Make sure vacuum is grounded and periodically touch some grounded metal surface away from the kiln to discharge the energy.

# CAUTION INSTRUCTIONS FOR L&L KILNS

## **GENERAL MAINTENANCE CAUTIONS**

### **ELECTRICAL SAFETY**

1. Shut off kiln when servicing it. Use an approved lock out/tag out procedure to make sure that no one servicing the kiln gets injured or killed.
2. **The elements carry high voltage and can electrocute you.** Many of the tests described in the troubleshooting manual are performed under power. They should be done ONLY by someone who is familiar with electrical safety such as an electrician or trained maintenance person.
3. As long as the kiln is unplugged or turned off at the fused disconnect switch or circuit breaker (and checked with a reliable meter to be sure) you are safe.
4. **When checking element resistance, disconnect kiln from power by unplugging kiln or turning off at the fused disconnect switch or circuit breaker. Lock out if appropriate.**

### **CHECK WIRES & TERMINALS**

1. Check wires for deterioration or oxidation or burns.
2. Replace any that seem brittle or where the wire insulation has deteriorated, fallen off or burned off.
3. Check terminals for oxidation (discoloration).
4. If you are near salt air or if you notice corrosion on the stainless exterior of the kiln for whatever reason (like certain fumes generated by your work) then do this far more frequently.
5. Check power connection terminals in the kiln and control box for tightness. Be sure to do this with the power disconnected (unplugged) for the kiln. If these terminal connections get loose heat can be generated (because the electrical resistance gets greater) and this can cause a fire.
6. Check thermocouple connections for corrosion, tightness and oxidation as well. A bad thermocouple connection can change the accuracy of the temperature reading which could cause an overfiring.

### **CHECK TEMPERATURE OF CORD**

1. Occasionally check temperatures of the main power cord at the main receptacle and the main kiln breaker while the kiln is at its hottest.
2. If these are hotter than normal, it could be a sign of a loose or corroded connection, or possibly the wire gauge used in the power hook-up is the wrong size for the amount of current being drawn by the kiln.

3. Immediately diagnose and fix this because it could cause a fire.
4. Also check temperature of any other cords on the kilns (such as element jumper cords).

### **CHECK FOR CORRODED CONNECTIONS**

1. When replacing infinite zone switches (and other electrical components), replace the electrical connectors.
2. At the very least check for discoloration (an indication of oxidation).
3. Electrical connectors will typically oxidize over time where there is heat and this can cause further overheating of the part at the connection point. This can in turn lead to early failure of the part, wire and connector.
4. Make certain that the new connectors are firmly crimped onto the wire.

### **THE WRONG PARTS CAN BE HAZARDOUS**

1. **Non-L&L elements can present a potential hazard to the kiln or cause a fire (by drawing too much amperage).**
2. The wrong type of fuse, relay, switch or other component can cause a fire or other hazardous condition.
3. An improperly rated cord can cause a fire.

### **VIDEO ABOUT GENERAL MAINTENANCE**

See this video for some general maintenance tips:  
[hotkilns.com/maintaining-kiln](http://hotkilns.com/maintaining-kiln)



# CAUTION INSTRUCTIONS FOR L&L KILNS

## **KILN MODIFICATIONS CAUTIONS**

---

### **COATINGS**

1. We can not at this time recommend any coatings for the elements.
2. Use of ceramic coatings will void the warranty on the elements and potentially the firebrick or element holders if it contaminates them.
3. Some people have reported success with ITC coating and some people seemed to have caused problems with this coating.
4. We have not adequately tested these coatings so we can only say, at this time, that any trouble that results from the use of ITC and other coatings must be at the risk of the user.
5. We do use a proprietary coating on all our firebrick that improves firebrick life and reduces dusting.

### **OTHER MODIFICATIONS**

1. All customer modification is made solely at the risk of the customer.
2. Modifications will void the warranty.
3. L&L takes no responsibility for hazardous conditions created by unauthorized modifications.
4. Any authorization for an engineering change must be in writing from the factory.

### **DO NOT OVERINSULATE KILN**

1. You may add insulation to the bottom, and to some extent the top.
2. If you put too much insulation on a lid it may weaken because it relies on the cooling of the lid to maintain its structural strength. This could lead to cracking or potentially a collapse of the lid.
3. See the various troubleshooting guides for information about this.
4. However, never wrap insulation around the perimeter of a typical sectional kiln.
5. You could trap heat in the wiring boxes and cause an electrical fire.
6. Also the stainless steel wrap that hold the kiln together will expand and loosen the structure of the kiln.

# REGULAR MAINTENANCE OF YOUR L&L KILN

## WATCH THIS VIDEO

This video shows you the basics of how to do routine maintenance on your L&L kiln:

[hotkilns.com/maintaining-kiln](http://hotkilns.com/maintaining-kiln)

## REGULAR KILN MAINTENANCE

To keep your kiln in top operating condition, we recommend the following minimum housekeeping:

### AFTER EACH FIRING

1) Turn off the kiln at the circuit breaker or fused disconnect switch.

2) Check element holders and walls for glaze, clay chips or anything that could melt at a high temperature. If melted clay or glaze comes in contact with an element, a rapid failure could result. The molten material traps the heat radiating from the element and subsequently raises the surface temperature of the wire. The temperature will quickly pass the maximum recommended for the wire and burn it up. To clean holders, a good shop vacuum with a HEPA filter will handle dust and loose crumbs. A very gentle chisel or grinder may help with glaze contamination on element holders, but remember that the elements themselves are quite brittle when they are cool. Replace the contaminated holder if you can not clean it. Remove any glaze that has splattered on the firebrick or shelves.

**(CAUTION: USE SAFETY GLASSES WHEN DOING THIS BECAUSE GLAZE CAN BE LIKE BROKEN GLASS).**

Vacuum afterward.

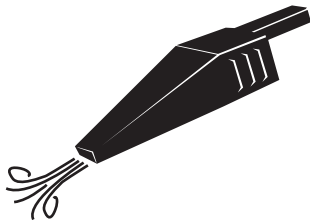

**VACUUMING NOTE:** It is possible to build up a strong static electricity charge when you are vacuuming. If this somehow manages to discharge into the control it can ruin the electronic circuit. Make sure the vacuum is grounded and periodically touch some grounded metal surface away from the kiln to discharge the energy.

3) Make sure the tops of the shelves are coated with kiln wash as it will keep running glaze from ruining the shelf. Some people also apply the kiln wash to the kiln bottom. Because this has both its benefits and detractants, we recommend that it only be done based on the kiln user's individual preferences. (Do not coat the undersides or the

sides of the shelves because you do not want the kiln wash to fall off into the kiln).

4) Keep a kiln log of firings. Tracking the performance of your kiln over time may turn out to be an extremely valuable tool if you ever need to diagnose future problems. Remember that you can easily get the firing time and final temperature at the end of the firing by hitting the Prog Review button if you have a DynaTrol.

### CAUTION: KILN WASH AND CLAY CONTAIN SILICA

1. Long term exposure to silica dust could cause lung damage.
2. See the MSDS sheets.
3. Exercise proper caution when mixing the dry powder and when removing it from your shelves.
4. Use a NIOSH approved particulate respirator for dust and use proper ventilation. You can buy these from safety supply houses. (NIOSH\_approval #TC-21C-132 is an example).

### AFTER 10 FIRINGS

1) Check temperatures of the main power cord at the main receptacle and the main kiln breaker while the kiln is at its hottest. If these are hotter than normal, it could be a sign of a loose or corroded connection, or possibly the wire gauge used in the power hook-up is the wrong size for the amount of current being drawn by the kiln. Immediately diagnose and fix this because it could cause a fire.

2) If you have a plug on your kiln, unplug it from the receptacle and check for oxidation, any burn marks, discoloration, or melted spots on the plug. If you see this replace the plug (and the receptacle) before using the kiln again. Make sure the receptacle feels tight when you press the plug into the outlet. A loose receptacle indicates worn springs, which will lead to overheating.

**NOTE:** An oxidation inhibitor can be used on the plug's prongs.

3) Check element resistance. You will need a digital multimeter (see the Troubleshooting Guide). Keep track of this information.

4) Check tightness of case and retighten if necessary. (the case will expand and contract during each firing and may eventually become loose. Brick also shrinks slightly with

# REGULAR MAINTENANCE OF YOUR L&L KILN

use - especially if used at the higher temperatures like cone 10).

5) Repair any firebrick problems.

6) If you have a manual kiln (or the Orton AutoCone backup on an automatic kiln) be sure it is properly adjusted. See the AutoCone instructions. Overfiring could result. The tube assembly should be replaced if it gets overly corroded or contaminated with condensed glaze or other materials. Orton recommends checking the pivot point for corrosion and sluggishness every 6 to 12 months.

## AFTER 30 FIRINGS OR ANNUALLY

1) Check wires for deterioration or oxidation. Replace any that seem brittle or where the wire insulation has deteriorated or fallen off.

2) Check terminals for oxidation (discoloration). If you are near salt air or if you notice corrosion on the stainless exterior of the kiln for whatever reason then do this far more frequently.

3) Check power connection terminals in the kiln and control box for tightness. Be sure to do this with the power disconnected (unplugged) for the kiln. If these terminal connections get loose, heat can be generated (because the electrical resistance gets greater) and this can cause a fire.

## CHECK THERMOCOUPLE CALIBRATION

Thermocouples will drift in reading over time. This could potentially lead to an overfiring before the thermocouple actually fails. Although you can not easily check thermocouple calibration, the general accuracy of the entire kiln system can be checked by firing with witness cones. See *troubleshoot-cones.pdf*.

Replace thermocouples once they are no longer reasonably accurate. (Note: Type K thermocouples last about the same as kiln elements so it is recommended to change thermocouples when you change elements.)

# OPERATION OF L&L KILNS WITH A ONE-TOUCH™ (Deg C)

Basic instructions are printed directly on the faceplate for easy reference.

Press the Enter button to start the program you have selected to fire.

Press and hold down Delay to enter a countdown time to delay the start of your program.

Press and hold down Review to see what program you are running.



The display area provides lots of information such as temperatures, program prompts, etc.

Choose one of either the Bisque or Glaze programs. They are preprogrammed for immediate no hassle use. Press for 5 seconds to bring up easy options like cone, heating & cooling rate and hold time

The Custom option allows more experienced users to create and save four of your own ramp/hold programs.

## 22. TABLE OF CONTENTS

<b>1. WATCH THE VIDEO FIRST!</b> .....	2
<b>2. HOW YOUR KILN WORKS</b> .....	2
<b>3. TYPEFACE CONVENTIONS</b> .....	2
<b>4. NOTE ABOUT CONES</b> .....	2
<b>5. CONE 6 &amp; CONE 10 VERSIONS</b> .....	2
<b>6. DEGREES CENTIGRADE</b> .....	2
<b>7. FIRST FIRING</b> .....	3
7.1 FIRST FIRING IN ONE FIRING (16 HOURS) .....	3
7.1.1 START.....	
7.1.2 CHOOSE CUSTOM PROGRAMMING .....	
7.1.3 PICK CUSTOM PROGRAM #1 .....	
7.1.4 MOVE THROUGH THE PROGRAM AND START .....	
7.1.5 REVIEW PROGRAM .....	
7.1.6 COMPLETE .....	
7.2 FIRST FIRING IN TWO FIRINGS (2 x 9 HOURS) .....	3
<b>8. TURNING ON THE KILN</b> .....	3
<b>9. THREE MODES OF OPERATION</b> .....	4
9.1 SIMPLE (Bisque or Glaze) .....	4
9.2 SIMPLE WITH CHANGES (Bisque or Glaze).....	4
9.2.1 TO CHANGE A SIMPLE OPTION .....	
9.2.2 EXAMPLE: CHANGE CONE OF BISQUE FIRE .....	
9.2.3 EXAMPLE: CHANGE SPEED OF BISQUE FIRE .....	
9.3 CUSTOM (Ramps and Holds):.....	5
<b>10. RESETTING FACTORY DEFAULTS</b> .....	6
<b>11. HOW TO CANCEL A FIRING</b> .....	6
<b>12. STANDARD (SIMPLE) PROGRAMS</b> .....	6
12.1 STANDARD BISQUE PROGRAMS.....	6
12.1.1 Slow Bisque (Default Bisque Program): .....	
12.1.2 Medium Speed Bisque: .....	
12.1.3 Fast Speed Bisque: .....	
12.2 STANDARD GLAZE PROGRAMS.....	7
12.2.1 Slow Glaze: .....	
12.2.2 Medium Glaze (Default Glaze Program): .....	
12.2.3 Fast Glaze: .....	
12.3 SIMPLE COOL DOWN SPEEDS.....	7
<b>13. CUSTOM RAMP/HOLD PROGRAMMING</b> .....	7
13.1 REUSE A PREVIOUS PROGRAM .....	8

13.2 CHANGING A PROGRAM (STEP BY STEP).....	8
13.2.1 START .....	
13.2.2 CHOOSE CUSTOM PROGRAMMING .....	
13.2.3 PICK A PROGRAM .....	
13.2.4 SPECIFY NUMBER OF SEGMENTS .....	
13.2.5 ENTER RAMP RATE .....	
13.2.6 ENTER HOLD TEMPERATURE .....	
13.2.7 ENTER HOLD TIME .....	
13.2.8 REPEAT STEPS FOR EACH SEGMENT .....	
13.2.9 SET A DELAY (OPTIONAL - CAN BE SKIPPED) .....	
13.2.10 START FIRING! .....	
13.2.11 REVIEW PROGRAM .....	
13.2.12 COMPLETE THE FIRING .....	
<b>14. KILN OPERATION DURING A CUSTOM FIRING PROGRAM</b> .....	9
14.1 DESCRIPTION .....	9
14.2 OPTIONS DURING FIRING .....	10
14.2.1 DISPLAYING THE CURRENT SET-POINT AND ACCESSING THE FOLLOWING OPTIONS .....	
14.2.2 SKIP STEP .....	
14.2.3 ADD TIME TO HOLD PERIOD .....	
14.2.4 ADD TEMPERATURE TO HOLD PERIOD .....	
<b>15. CUSTOM PROGRAMS</b> .....	11
15.1 CUSTOM PROGRAM 1:.....	11
15.2 CUSTOM PROGRAM 2:.....	11
15.3 CUSTOM PROGRAM 3:.....	11
15.4 CUSTOM PROGRAM 4:.....	11
<b>16. OPTIONS</b> .....	11
16.1 ACCESSING OPTIONS.....	11
16.2 OPTIONS.....	11
16.2.1 SOUND: BEEPING ON OR OFF AT END OF PROGRAM .....	
16.2.2 MAXIMUM TEMPERATURE .....	
16.2.3 TEMPERATURE INDICATION .....	
16.2.4 THERMOCOUPLE OFFSET .....	
<b>17. MESSAGES &amp; DISPLAYS</b> .....	12
<b>18. ERROR CODES</b> .....	13
<b>19. SOFTWARE VERSION</b> .....	13
<b>20. FAHRENHEIT INSTRUCTIONS</b> .....	13
<b>21. SPECIFICATIONS</b> .....	13

# OPERATION OF L&L KILNS WITH A ONE-TOUCH™ (Deg C)

## 1. WATCH THE VIDEO FIRST!

---

We highly recommend watching the video before you read this instruction manual for quicker understanding of how this great control works. Go to [hotkilns.com/one-touch-video](http://hotkilns.com/one-touch-video)

## 2. HOW YOUR KILN WORKS

---

The One-Touch™ Intuitive Kiln Control was designed for busy school teachers, contemporary studios, and hobbyists. No programming is necessary - simple adjustments are easy, yet sophisticated programming is also easy.

The One-Touch automatic program control uses one thermocouple to measure the temperature of the kiln.

The control automatically adjusts power by turning power contactors on and off to control the heat up of the kiln according to the program you are firing.

The preprogrammed Bisque and Glaze programs are set to fire to the most universally accepted versions of these programs, which makes firing basic ceramics easy. These are a slow bisque to Cone 04 and a Medium Glaze to Cone 06.

There are three modes of operation:

1. **Simple** (just the basic Bisque and Glaze programs as mentioned above)
2. **Simple with Changes** (you can adjust a few basic parameters like heat up speed, cool down speed, candling time at a low temperature, and the cone to fire to)
3. **Custom** where you program all ramps and holds yourself.

## 3. TYPEFACE CONVENTIONS

---

1. Typeface font: **CUSTOM** indicates a Button on the control.
2. Typeface font: **CUS1** indicates what you see in the display.
3. Typeface font: **URL** indicates a web link.

## 4. NOTE ABOUT CONES

---

Cones measure “heat work” rather than just final set point temperature. It is like baking a turkey. You can bake it slow at a low temperature or bake it fast at a high temperature.

The One-Touch™ control adjusts the final set point temperature based on the **actual** final ramp rate of the kiln (in the last segment of any program). It does this to achieve a particular result (which is the correct bending of the cone) rather than a particular final temperature.

For a full explanation of cones go to [hotkilns.com/what-cone-numbers-mean](http://hotkilns.com/what-cone-numbers-mean)

If you want to see the Orton Cone Chart go to [hotkilns.com/orton-cone-chart](http://hotkilns.com/orton-cone-chart).

**Note: you can adjust how the kiln fires by adjusting the thermocouple offset.** For instance, if your kiln is firing cool (according to a witness cone placed in the kiln) then you can add positive Offset. If it is firing hot then you can reduce the offset or put in a negative offset. See the **OPTIONS** section on page 11 for instructions on how to do this.

## 5. CONE 6 & CONE 10 VERSIONS

---

There are two versions of the control: Cone 6 and Cone 10. The Cone 6 versions are used on the School-Master kilns to limit the maximum temperature of the kiln. Liberty-Belle, Doll, Fuego and Robin kilns use the Cone 10 version. There are only minor differences as noted in these instructions. The main issue is the maximum temperature that the control will let the kiln go to.

## 6. DEGREES CENTIGRADE

---

Your control comes set up to display Degrees Centigrade. This can easily be changed to display in Degrees Fahrenheit (see the **OPTIONS** section).



# OPERATION OF L&L KILNS WITH A ONE-TOUCH™ (Deg C)

## 7. FIRST FIRING

---

Three of the **CUSTOM** programs have been programmed by the factory to simplify the first firing process.

Once this process has been completed they may be reprogrammed at will.

### 7.1 FIRST FIRING IN ONE FIRING (16 HOURS)

#### 7.1.1 START.

1. Start with the display reading **IdLE** and flashing a temperature or **StOP** and temperature.

#### 7.1.2 CHOOSE CUSTOM PROGRAMMING

1. Press **CUSTOM**
2. See **CUS<sub>t</sub>**
3. Press **ENTER**

#### 7.1.3 PICK CUSTOM PROGRAM #1

1. You will see **CUS<sub>1</sub>**, **CUS<sub>2</sub>**, **CUS<sub>3</sub>** or **CUS<sub>4</sub>**. These are the four custom programs.
2. Scroll to **CUS<sub>1</sub>** with the **UP** and **DOWN** button.
3. Select **CUS<sub>1</sub>** by pressing the **ENTER** button.

#### 7.1.4 MOVE THROUGH THE PROGRAM AND START

1. Press **ENTER** for each display prompt that you see as the control scrolls through the enter **CUS<sub>1</sub>** program until you see **FIrE**.
2. Press **ENTER** again when you see **FIrE** and the One-Touch control will start firing the kiln using the **CUS<sub>1</sub>** program.
3. You will know it is firing because the display just reads the kiln temperature steadily. You will probably also hear the relays clicking on and off.
4. There is a list of Preprogrammed Custom Programs later in this manual which will show you a list of values for **CUS<sub>1</sub>** you see while pressing **ENTER**.

#### 7.1.5 REVIEW PROGRAM

1. Press the **REVIEW** button to review the program.
2. You can do this when you see the **FIrE** display, **CUS<sub>1</sub>**, **CUS<sub>2</sub>**, **CUS<sub>3</sub>**, **CUS<sub>4</sub>** or while firing (when you see the kiln temperature).
3. The display will scroll though the name of the program (i.e. **CUS<sub>4</sub>**), then the number of segments, then all the

ramps, temperatures and holds in sequence.

4. The display changes rapidly so you may have review more than once to see everything.

#### 7.1.6 COMPLETE

1. When the program is complete, you will see **CPLt**.
2. If the Beep option has been turned to "**0n**" then the control will beep about 15 times. If the beep option is set for "**OFF**," then there is no sound. If the beep option is set for "**FULL**," the control will beep until any button is pressed. See the **OPTIONS** section for how to change this option.

#### 7.1.7 FIRST FIRING IN TWO FIRINGS (2 x 9 HOURS)

1. Go through the above process but do it in two programs. It works the same as above except that you run the two separate programs at different times.
2. **CUS<sub>2</sub>** is the first program and that takes about 9 hours.
3. **CUS<sub>3</sub>** is the second program and that also takes about 9 hours.
4. See the list of Preprogrammed Custom Programs later in this manual for a list of values you see while pressing **ENTER**.

## 8. TURNING ON THE KILN

---

1. Make sure your circuit breaker or fused disconnect switch is turned on and the kiln is plugged in.
2. Turn on kiln with the toggle On/Off switch on the control box.
3. You will see a software code flash briefly. Then you will see either **IdLE** or **StOP** alternating with a display of the current kiln temperature.

## 9. THREE MODES OF OPERATION

---

### 9.1 SIMPLE (Bisque or Glaze)

1. Press one of two buttons marked **BISQUE** and **GLAZE**.
2. You will then see either **bISC** or **GLA** depending on which button you pressed.
3. The **bISC** is a slow bisque to Cone 04. The **GLA** is a medium glaze to Cone 06.
4. Press **ENTER** and the display reads **FIrE**.

# OPERATION OF L&L KILNS WITH A ONE-TOUCH™ (Deg C)

5. You can add a delay time to the program by pressing the **DOWN** arrow when you see **FIrE** but before you press **ENTER**.
6. After you press the **DELAY** button, you will see **dELA** flashing with a time value, typically **00.00** which represents 00 hours and 00 minutes.
7. After you see this flashing display, you can press the **UP** or **DOWN** button to adjust the time. For instance if you want a delay time of one hour and thirty minutes you would enter a value of **01.30**.
8. Once you have the value you want, press **ENTER** and you will see **FIrE** again.
9. This will delay the start of the actual firing by the number of minutes and hours that you have chosen.
10. Press **ENTER** and the control will begin the firing cycle. If you have entered a delay, then you will see **dLY** flashing with a countdown of the time (for example **01:30** for 1 hour and 30 minutes)
11. Press the **REVIEW** button to review the program.
12. You can do this when you see the **FIrE** display (which will be before the kiln has started to fire) or while firing (when you just see temperature continuously).
13. The display will scroll though:
  - The name of the program (i.e. **bISC**)
  - Then **CndL** (for candle low fire followed by a time)
  - Then **COnE** followed by a number like **04**
  - Then **°F** or **°C** to let you know the temperature scale
  - Then a temperature like **1063** which is the anticipated maximum temperature.
  - Then **HLd** followed by a time value like **00:00**, which is any hold time at top temperature that you may have programmed into the control.
  - NOTE: Setting for **COOL** and **HtUP** are not shown so you need to make sure these are right before you fire your program.
14. Press **ENTER** anytime to stop the program.
15. When the program is complete, you will see **CPLt**.
16. If the Beep option has been turned to “**On**,” then the control will beep about 15 times. If it was set for “**OFF**,” then there will be no beeping. If it was set for “**FULL**,” then it will beep until a button is pressed. (See Options later in the manual for how to set this.)

## 9.2 SIMPLE WITH CHANGES (Bisque or Glaze)

It is easy to change simple options like candle time, cone to fire to, hold time at peak temperature, cool-down rate and heat-up rate (plus, you can restore the default values in case you lose track of where you are).

**Note that the heat up rate is what changes a Bisque or a Glaze program to Slow, Medium or High.**

### 9.2.1 TO CHANGE A SIMPLE OPTION

1. When you press **BISQUE** or **GLAZE** and hold it for 5 seconds, then you will see either **CndL**, **COnE**, **HLd**, **COOL**, **rStr**, or **HtUP**.
2. Once you see one of these displays remove your finger from the button. (**NOTE: If you do not hit another button for 5 seconds the control will return to idle. If this happens just start over.**)
3. Once you see any of these displayed options you can scroll to other displayed options by pressing the **UP** or **DOWN** button.
4. Here are the options you can change:

<b>CndL</b>	Candle Time (this is a low temperature firing used to dry moisture from the clay)
<b>COnE</b>	Cone to fire to ( <b>022</b> to <b>10</b> )
<b>HLd</b>	Hold or Soak time at peak temperature in hours and minutes up to 99 hours and 99 minutes (Format: <b>00.00</b> )
<b>COOL</b>	Cool down rate. <b>OFF</b> (natural cooling), <b>SLO</b> (Slow = 52°C/hour), <b>MEd</b> (Med = 121°C/hour), <b>FAST</b> (Fast = 260°C/hour)
<b>rStr</b>	Restore default original values
<b>HtUP</b>	Heat up rates. <b>SLO</b> (Slow), <b>MEd</b> (Medium), <b>FAST</b> (Fast). This is what changes the program to Slow, Medium or High. The rates depend on whether you are in Glaze or Bisque - see the programs later in the manual for details.

5. Once you see the what you want to change press **ENTER**.
6. Once you have entered a option to change, the **UP** and **DOWN** button will then allow adjustment of the value of that particular option.

# OPERATION OF L&L KILNS WITH A ONE-TOUCH™ (Deg C)

7. Once you see the value you want press **ENTER** to select and save.
8. The display will then cycle back to the starting display of the control. (You will see **IdLE** or **StOP** alternating with a display of the current kiln temperature).
9. To change another option go through the process again.
10. You can not change more than one option at a time.

## 9.2.2 EXAMPLE: CHANGE CONE OF BISQUE FIRE

Change the cone that the Bisque program goes to from  $\Delta 04$  to  $\Delta 06$ :

1. Press the **BISQUE** Button for 5 seconds or more.
2. See **CndL** or **COnE** or **HLd** or **COOL** or **rStr** or **HtUP**.
3. Release your finger from the button.
4. Scroll to **COnE** display by pressing the **UP** or **DOWN** button.
5. Press **ENTER** to change the value of the **COnE** option.
6. See **04** alternating with **COnE**
7. Press the **DOWN** button until you see **06**
8. Press **ENTER**
9. See either **IdLE** or **StOP** alternating with a display of the current kiln temperature.

## 9.2.3 EXAMPLE: CHANGE SPEED OF BISQUE FIRE

Change the speed of firing for the Bisque program from Slow to Fast.

1. Press the **BISQUE** Button for 5 seconds or more.
2. See **CndL** or **COnE** or **HLd** or **COOL** or **rStr** or **HtUP**.
3. Release your finger from the button.
4. Scroll to **HtUP** display by pressing the **UP** or **DOWN** button.
5. Press **ENTER** to change the value of the **HtUP** option.
6. See **SL0** alternating with **HtUP**
7. Press the **DOWN** button until you see **FASt**
8. Press **ENTER**

9. See either **IdLE** or **StOP** alternating with a display of the current kiln temperature.

Note - the temperatures, ramps and soak times that for the various preset bisque and glaze programs, are shown later on. These charts are for your reference only - when you are using the Simple mode of operation - you can not change any of those ramp and hold settings - just the overall grouping of ramps and holds that makes up the "slow", "medium" and "fast" setting.

## 9.3 CUSTOM (Ramps and Holds):

1. Press **CUSTOM** and you have four Ramp/Soak programs available for sophisticated custom programming.
2. Each program has eight segments.
3. Each segment has a ramp, a temperature set point, and a hold time for each segment.
4. See "CUSTOM RAMP/HOLD PROGRAMMING" later in manual for detailed instructions on how to program in the Custom mode of operation.

## 10. RESETTNG FACTORY DEFAULTS

It is natural, when first learning a new technology, to get confused or to put in something you are not sure of and then not know where the beginning is. If you do this and you want to go back to the factory defaults so you begin from scratch do the following:

1. Press the **BISQUE** Button for 5 seconds or more.
2. See **CndL** or **COnE** or **HLd** or **COOL** or **rStr** or **HtUP**
3. Release your finger from the button.
4. Scroll to **rStr** display by pressing the **UP** or **DOWN** button.
5. Press **ENTER** to change restore the control to its factory default values
6. See either **IdLE** or **StOP** alternating with a display of the current kiln temperature.
7. Repeat the same process for **GLAZE**

## 11. HOW TO CANCEL A FIRING

1. Just press **ENTER** while the kiln is firing.
2. You will see either **IdLE** or **StOP** alternating with a display of the current kiln temperature.

# OPERATION OF L&L KILNS WITH A ONE-TOUCH™ (Deg C)

## 12. STANDARD (SIMPLE) PROGRAMS

The following tables show you exactly how the control is set up so you can understand what is going on “under the hood”.

1. You can not change the way the ramps, holds and temperature set points are set - if you need or want to do that then you need to use Custom Programming.
2. The “Default Bisque Program” is a Slow Bisque and the “Default Glaze Program” is a Medium Glaze.
3. “Slow”, “Medium” and “Fast” refer to the ramp speeds and lengths of the programs.
4. When you change the speed of the Cooldown this goes from **OFF** (no controlled cooling or no heat at all when cooling), to **FAST** (Fast = 260°C/hour) **MEd** (Medium = 121°C/hour) to **SL** (Slow = 52°C/hour).
5. We recommend experimenting with slower cooldowns for interesting effects on glazing. It is usually irrelevant for bisquing.

### 12.3.1 STANDARD BISQUE PROGRAMS

Slow, Medium and Fast Settings for the Bisque programs are listed.

Note: Final temperatures are based on Orton cone charts (Small Self-Supporting Cones). For instance, Cone 04 is 1063° C and Cone 06 is 998° C. The second-to-last temperature is the cone temperature minus 124° C. If you want to see the Orton Cone Chart go to [hotkilns.com/orton-cone-chart](http://hotkilns.com/orton-cone-chart).

Note: Seg 1 is the candling segment. This segment is skipped if the **CndL** option is set to “**00.00**”.

You can download an Excel spreadsheet that will generate any program (with graph and times) based on a particular cone number at [hotkilns.com/one-touch-calculator](http://hotkilns.com/one-touch-calculator).

Times are calculated assuming a room temperature of 21°C

### 12.3.2 Slow Bisque (Default Bisque Program):

#### A04 Standard Slow Bisque – SEGS-6 (6 segments)

Seg 1-	10.21 Hrs	RA1 - 14°C/Hr	° C1-66°C	HOLD- 7.0
Seg 2-	3.35 Hrs	RA2 - 38°C	° C2-85°C	HOLD- 3.0
Seg 3-	4.08 Hrs	RA3 - 93°C	° C3-538°C	HOLD- 00.00
Seg 4-	1.00 Hrs	RA4 - 38°C	° C4-593°C	HOLD- 00.00
Seg 5-	2.95 Hrs	RA5 - 93°C	° C5-921°C	HOLD- 00.00
Seg 6-	2.37 Hrs	RA6 - 42°C	° C6-1063°C	HOLD- 00.00

TOTAL FIRING TIME = 23.95 HRS

### 12.3.3 Medium Speed Bisque:

#### A04 Standard Medium Bisque – SEGS-6 (6 segments)

Seg 1-	1.00 Hrs	RA1 - 27°C	° C1-66°C	HOLD- 00.00
Seg 2-	0.44 Hrs	RA2 - 27°C	° C2-85°C	HOLD- 00.00
Seg 3-	0.81 Hrs	RA3 - 27°C	° C3-121°C	HOLD- 00.00
Seg 4-	3.00 Hrs	RA4 - 121°C	° C4-538°C	HOLD- 00.00
Seg 5-	3.83 Hrs	RA5 - 82°C	° C5-921°C	HOLD- 00.00
Seg 6-	2.37 Hrs	RA6 - 42°C	° C6-1063°C	HOLD- 00.00

TOTAL FIRING TIME = 10.45 HRS

### 12.3.4 Fast Speed Bisque:

#### A04 Standard Fast Bisque – SEGS-6 (6 segments)

Seg 1-	0.53 Hrs	RA1 - 66°C	° C1-66°C	HOLD- 00.00
Seg 2-	0.23 Hrs	RA2 - 66°C	° C2-85°C	HOLD- 00.00
Seg 3-	0.43 Hrs	RA3 - 66°C	° C3-121°C	HOLD- 00.00
Seg 4-	2.83 Hrs	RA4 - 149°C	° C4-593°C	HOLD- 00.00
Seg 5-	1.47 Hrs	RA5 - 204°C	° C5-921°C	HOLD- 00.00
Seg 6-	2.37 Hrs	RA6 - 42°C	° C6-1063°C	HOLD- 00.00

TOTAL FIRING TIME = 7.34 HRS

## 12.1 STANDARD GLAZE PROGRAMS

1. Slow, Medium and Fast Settings for the Glaze programs are listed.
2. Note: Final temperatures are based on Orton cone charts (Small Self-Supporting Cones). For instance, Cone 04 is 1063° C and Cone 06 is 998° C. The second-to-last temperature is the cone temperature minus 124° C. If you want to see the Orton Cone Chart go to [hotkilns.com/orton-cone-chart](http://hotkilns.com/orton-cone-chart).
3. Note: Seg 1 is the candling segment. This segment is skipped if the **CndL** option is set to “**00.00**”.
4. You can download an Excel spreadsheet that will generate any program (with graph and times) based on a particular cone number at [hotkilns.com/one-touch-calculator](http://hotkilns.com/one-touch-calculator).
5. Times are calculated assuming a room temperature of 21°C

# OPERATION OF L&L KILNS WITH A ONE-TOUCH™ (Deg C)

## 12.1.1 Slow Glaze:

### Δ06 Slow Glaze – SEGS–3 (3 segments)

Seg 1-	0.45 Hrs	RA1 - 222°C	° C1–121°C	HOLD- 00.00
Seg 2-	3.31 Hrs	RA2 - 222°C	° C2–856°C	HOLD- 00.00
Seg 3-	2.00 Hrs	RA3 - 71°C	° C3–998°C	HOLD- 00.00

TOTAL FIRING TIME = 5.30 HRS

## 12.1.2 Medium Glaze (Default Glaze Program):

### Δ06 Medium Glaze – SEGS–3 (3 segments)

Seg 1-	0.29 Hrs	RA1 - 222°C	° C1–85°C	HOLD- 00.00
Seg 2-	3.47 Hrs	RA2 - 222°C	° C1–856°C	HOLD- 00.00
Seg 3-	1.71 Hrs	RA3 - 83°C	° C2–998°C	HOLD- 00.00

TOTAL FIRING TIME = 5.17 HRS

## 12.1.3 Fast Glaze:

### Δ06 Fast Glaze – SEGS–3 (3 segments)

Seg 1-	0.20 Hrs	RA1 - 317°C	° C1–85°C	HOLD- 00.00
Seg 2-	2.43 Hrs	RA2 - 317°C	° C2–856°C	HOLD- 00.00
Seg 3-	1.28 Hrs	RA3 - 11°C	° C3–998°C	HOLD- 00.00

TOTAL FIRING TIME = 3.71 HRS

## 12.2 SIMPLE COOL DOWN SPEEDS

Note: These are entered as one of the simple options in the Simple Programming (**C00L**).

Cool Down options are as follows:

1. **Off** = no controlled cooldown
2. **Slow** = 69.4°C/hour
3. **Med** = 138.8°C/hour
4. **Fast** = 277.7°C/hour

## 13. CUSTOM RAMP/HOLD PROGRAMMING

1. Each fully customizable program has eight segments.
2. Each segment has a ramp rate, a hold time and a temperature set point.
3. Ramp Rate is some number of degrees centigrade per hour either increasing or decreasing in temperature. For example a ramp rate of **27** means that the program will move from the temperature at the beginning of the segment to the temperature at the end of the segment

at 27 degrees centigrade per hour.

4. Hold time is a time that the program holds the temperature reached at the end of the segment. It can be set for **00.00** and, in fact, in most cases is.
5. The temperature set point is the final temperature intended to be reached in the segment.
6. At the end of the segment, i.e. when the program reached the temperature set point and finishes any hold time the control will move to the next segment. If it is the last segment then the program will be complete (**CPLt**).

## 13.1 REUSE A PREVIOUS PROGRAM

1. Start with the display reading **IdLE** and flashing a temperature or **StOP** and temperature.
2. Select **CUSTOM**
3. See **CUSt**
4. Press **ENTER**
5. You will see **CUS1**, **CUS2**, **CUS3** or **CUS4**.
6. These are the four custom programs.
7. You can scroll to other ones with the **UP** and **DOWN** button.
8. When the display shows the one you want to select press **ENTER**.
9. After you have selected your program with **ENTER** press the **REVIEW** button.
10. This will scroll through all the segments so you can see what is programmed in that custom program and the end up with **FIRe**. Press **ENTER** when you see **FIRe** and the program will start.

## 13.2 CHANGING A PROGRAM (STEP BY STEP)

### 13.2.1 START

1. Start with the display reading **IdLE** and flashing a temperature or **StOP** and temperature.

### 13.2.2 CHOOSE CUSTOM PROGRAMMING

1. Select **CUSTOM**
2. See **CUSt**
3. Press **ENTER**



# OPERATION OF L&L KILNS WITH A ONE-TOUCH™ (Deg C)

## 13.2.3 PICK A PROGRAM

1. You will see **CUS1**, **CUS2**, **CUS3** or **CUS4**.
2. These are the four custom programs.
3. You can scroll to other ones with the **UP** and **DOWN** button.
4. When the display shows the one you want to select press **ENTER**.

## 13.2.4 SPECIFY NUMBER OF SEGMENTS

1. Once you have chosen a program, you need to specify the total number of segments that you will use.
2. All programs consist of 1 or more segments, as shown in the sample profiles in this manual.
3. Each segment has 3 parts: a ramp rate (speed of temperature rise in degrees centigrade per hour), hold temperature (in degrees centigrade), and hold time (in hours and minutes) at the hold temperature.
4. It is helpful to draw your profile to see how many segments you will need.
5. Then, use the **UP** and **DOWN** buttons to display the desired number of segments, and press **ENTER** to store the value when you see the number you want.

## 13.2.5 ENTER RAMP RATE

1. You will see **rA1**, followed by a value like **150**.
2. The **rA1** stands for Ramp One.
3. The value represents a rate of temperature rise expressed in degrees per hour.
4. Use the arrow buttons to adjust the rate and press **ENTER** to store the value.
5. To help you visualize what is typical of various ramps read the following:
6. Slow rates range from 1-50 degrees per hour, and are used for thick glass projects.
7. Medium rates range from 60 to 200 degrees per hour, and are used for thick, hand-built ceramics.
8. Fast rates range from 250–1000 degrees per hour, and are used for glazes, thin ceramics and small glass projects.
9. A rate of **9999** sets the kiln to ramp as fast as possible.
10. Also, see the various ramps in the standard programs

for an idea of what works.

## 13.2.6 ENTER HOLD TEMPERATURE

1. You will see **°C1** followed by a value like **0300**.
2. The **°C1** stands for Temperature One.
3. For a single segment program, this is the top temperature of the firing.
4. For multi-segment programs, this can be a temperature where you want to hold to dry the ware or for carbon burn-out, or to equalize the temperature across the item or it can be where you just want to switch ramp rates without a hold.
5. Adjust the temperature with the **UP** and **DOWN** buttons and press **ENTER** to store the displayed value.

## 13.2.7 ENTER HOLD TIME

1. You will see **HLd1** followed by a value like **00:00**.
2. The **HLd1** stands for Hold One.
3. Hours are displayed to the left of the decimal point and minutes to the right (HH.mm).
4. Use the **UP** and **DOWN** buttons to adjust the hold time at the soak temperature.
5. Use a zero (**00.00**) hold time if you just want to move to the next segment.
6. Drying ware can take several hours, while holds at peak temperature usually range 10–15 minutes to even out the kiln. Feel free to experiment - there is no one right way to program a kiln.

## 13.2.8 REPEAT STEPS FOR EACH SEGMENT

1. For segment two, the display will read **rA2**, **°C2** and **HLd2**
2. For segment three, the display will read **rA3**, **°C3** and **HLd3** etc.

## 13.2.9 SET A DELAY (OPTIONAL - CAN BE SKIPPED)

1. If you want to set a delay, you can do it when the display says **FIRe**.
2. You can add a delay time to the program by pressing the **DOWN** arrow when you see **FIRe** but before you press **ENTER**.
3. After you press the **DELAY** button you will see **dELA**

# OPERATION OF L&L KILNS WITH A ONE-TOUCH™ (Deg C)

flashing with a time value, typically **00.00** which represents 00 hours and 00 minutes.

4. After you see this flashing display, you can press the **UP** or **DOWN** button to adjust the delay time.
5. Once you see the value you want, press **ENTER** and you will see **FiRE** again.
6. This will delay the start of the actual firing by the number of minutes and hours that you have chosen.

## 13.2.10 START FIRING!

1. The display will show **FiRE** (ready to fire) when all segments have been entered.
2. Press **ENTER** to start the firing.

*Caution should be taken to make sure that no one can place anything around or on the kiln during the delay start. Treat the kiln as firing during the delay start.*

## 13.2.11 REVIEW PROGRAM

1. Press the **REVIEW** button to review the program.
2. You can do this when you see the **FiRE** display, **CUS1**, **CUS2**, **CUS3**, **CUS4** or while firing.
3. The display will scroll though and show you the following:
4. The name of the program (i.e. **CUS4**)
5. Then the number of segments (i.e. **2** )
6. Then all the ramps, temperatures and holds in sequence.

## 13.2.12 COMPLETE THE FIRING

1. When the firing is complete, you will see **CPLt**.
2. If the Beep option has been turned to "**On**" then the control will beep about 15 times. If it was set for "**OFF**," then there will be no beeping. If it was set for "**FULL**," it will beep until a button is pressed. (See Options later in the manual for how to set this.)

## 14. KILN OPERATION DURING A CUSTOM FIRING PROGRAM

### 14.1 DESCRIPTION

1. At the start of a firing, the controller sets its moving set-point to the current temperature in the kiln.
2. The moving set-point is where the controller wants the

kiln temperature to be.

3. The controller will then move the moving set-point up at the programmed rate, and cycle power to the elements to make the temperature of the kiln follow the moving set-point.
4. You will hear the relays clicking to regulate the kiln temperature.
5. The elements will receive power when the temperature is below the moving set-point.
6. The relays will click off when the temperature is above the moving set-point.
7. The current segment and moving set-point can be viewed by pressing the **UP** arrow during a firing.
8. The control can not make the kiln go any faster than it is capable of so there may be a lag between what the control wants to do and what the kiln can do. This is normal and is only of concern if the kiln starts firing slower than it normally has done in the past.

### 14.2 OPTIONS DURING FIRING

#### 14.2.1 DISPLAYING THE CURRENT SET-POINT AND ACCESSING THE FOLLOWING OPTIONS

1. During a firing, you may advance from the current segment to the next ramp rate by using **Skip Step (SStP)**; or, if you are in a hold period, you may add time (**tME**) and temperature (**tMP**) to the hold period.
2. When the **UP** button is pressed during a firing, the current ramp or hold is displayed, followed by the current or moving set-point, then **SStP** is displayed.
3. If you do not press a button within several seconds, the display will return to showing the current temperature in the kiln.

#### 14.2.2 SKIP STEP

1. This option allows you to skip from the present segment to the next ramp rate.
2. Press the **UP** button, the display will show the current segment, then the set-point, then **SStP**.
3. When **SStP** is displayed, press **ENTER** to skip to the next ramp rate.

#### 14.2.3 ADD TIME TO HOLD PERIOD

1. This is available only during a hold period.

# OPERATION OF L&L KILNS WITH A ONE-TOUCH™ (Deg C)

- This option allows you to add time in 5 minute increments to a hold (soak) period.
- During a hold or soak, the temperature in the kiln will be alternating in the display with the remaining hold time.
- When in a hold period, press the **UP** button.
- When **SS t P** is displayed, press the **UP** button again and **tME** will be displayed.
- Press **ENTER** and 5 minutes will be added to the hold time.
- You may use this procedure as many times as necessary to get the hold time that you want.

## 14.2.4 ADD TEMPERATURE TO HOLD PERIOD

- This is available only during a hold period.
- This option allows you to add temperature in 5 degree increments to a hold (soak) period.
- During a hold or soak, the temperature in the kiln will be alternating in the display with the remaining hold time.
- When in a hold period, press the **UP** button.
- When **SS t P** is displayed, press the **UP** button twice more and **tMP** will be displayed.
- Press **ENTER** and 5 minutes will be added to the hold time.
- You may use the add temperature procedure as many times as necessary to get the hold temperature desired.

## 15. CUSTOM PROGRAMS

- There are the four programs (shown in Degrees C) that can be fully customized.
- Three of these have been preprogrammed by the factory to simplify the first firing process.
- Once this process has been completed they may be reprogrammed anyway you like.

### 15.1 CUSTOM PROGRAM 1:

#### Standard First Firing Program:

#### A5 Standard Slow Bisque – SEGS–5 (5 segments)

Seg 1-	2.15 Hrs	RA1 - 44.4°C	° C1–121°C	HOLD-	00.00
Seg 2-	3.75 Hrs	RA2 - 111.1°C	° C2–538°C	HOLD-	00.00
Seg 3-	1.00 Hrs	RA3 - 55.5°C	° C3–593°C	HOLD-	00.00
Seg 4-	4.58 Hrs	RA4 - 100°C	° C4–1046°C	HOLD-	00.00

Seg 5- 3.12 Hrs RA5 - 44.4°C ° C5–1185°C HOLD- 00.00

TOTAL FIRING TIME = 15.6 HRS

### 15.2 CUSTOM PROGRAM 2:

#### Split First Firing (First Segment):

Seg 1-	2.15 Hrs	RA1 - 44.4°C	° C1–121°C	HOLD-	00.00
Seg 2-	3.75 Hrs	RA2 - 111.1°C	° C2–538°C	HOLD-	00.00
Seg 3-	1.00 Hrs	RA3 - 55.5°C	° C3–593°C	HOLD-	00.00
Seg 4-	2.22 Hrs	RA4 - 100°C	° C4–816°C	HOLD-	00.00

TOTAL FIRING TIME = 9.12 HRS

### 15.3 CUSTOM PROGRAM 3:

#### Split First Firing (Second Segment):

Seg 1-	0.85 Hrs	RA1 - 111.1°C	° C1–121°C	HOLD-	00.00
Seg 2-	2.50 Hrs	RA2 - 277.7°C	° C2–816°C	HOLD-	00.00
Seg 3-	2.30 Hrs	RA3 - 100°C	° C3–1046°C	HOLD-	00.00
Seg 4-	3.12 Hrs	RA4 - 44.4°C	° C4–1185°C	HOLD-	00.00

TOTAL FIRING TIME = 8.77 HRS

### 15.4 CUSTOM PROGRAM 4:

Blank - nothing is preprogrammed.

## 16. OPTIONS

### 16.1 ACCESSING OPTIONS

- Options are accessed by holding the **ENTER** button while turning the power onto the control (by turning on the kiln with the toggle switch) and continuing to hold onto the **ENTER** button until **EdIt** is displayed.
- This activates the Options Menu.
- The first thing you will see after turning the power on while pressing **ENTER** is **LL-G** or **It-I** (This is the software version).
- Then you will see **1288** if it is a Cone 10 control or **1249** if it is a Cone 6 control.
- Then you will see **EdIt** and you will hear a beep. You can now let go of the **ENTER** button.

### 16.2 OPTIONS

#### 16.2.1 SOUND: BEEPING ON OR OFF AT END OF PROGRAM

- The first thing to change is the action of the beeper.

# OPERATION OF L&L KILNS WITH A ONE-TOUCH™ (Deg C)

2. **OFF** turns off the beeper.
3. **FULL** makes the beeper stay on until any button is pushed.
4. **On** makes the beeper sound 15 times and then turn off.
5. If you don't want to change this option then press **ENTER**.

## 16.2.2 MAXIMUM TEMPERATURE

1. **On a Cone 6 Version (School-Master): Maximum Temperature** (Deg C) **927**, **1093**, and **1249** are options.
2. **On a Cone 10 Version (Liberty-Belle, Doll, Fuego, Robin):** Cone 10 models have a preset maximum temperature limit of **1288** and you will not see the "Maximum Temperature" option come up.

## 16.2.3 TEMPERATURE INDICATION

1. **°F** (Deg F) or **°C** (Deg C).
2. When you are in Deg C, you will always see a little dot in the display at the bottom right to remind you.
3. Use the **UP** or **DOWN** button to change the value and then press **ENTER**.

## 16.2.4 THERMOCOUPLE OFFSET

1. **OFFS** (+/- deg C)
2. Display shows **OFFS**.
3. Press the **UP** arrow to enter a positive offset.
4. Press the **DOWN** arrow to add a negative sign to the offset, and then the **UP** arrow to add negative offset to the control.
5. The control comes with a pre-programmed +8 Deg C offset to compensate for the thermocouple protection tube.
6. Note: if you first press the **DOWN** button you can only set a negative value or if you first press the **UP** button you can only enter a positive value.
7. You can go back and change this later if you make a mistake.

**Note: you can adjust how the kiln fires by adjusting the thermocouple offset.** For instance, if your kiln is firing cool (according to a witness cone placed in the kiln) then you can add positive Offset. If it is firing hot then you can reduce the

offset or put in a negative offset. Try doing this in 5 degree increments.

## 17. MESSAGES & DISPLAYS

**CndL** Candle Time (this is a low temperature firing used to dry moisture from the clay)

**COnE** Cone to fire to

**COOL** Cool down rate. **OFF** (natural cooling), **SLO** (Slow), **MEd** (Medium), **FAST** (Fast)

**CPLt** Firing Cycle Complete (firing time is alternately displayed).

**dELA** Delay. Displays when entering the delay time (hour:minutes) until the start of the firing.

**DLy** Delay. Alternates with the remaining delay time until the start of the kiln.

**°F#** Segment temperature in °F–Set temperature for a user program. (# stands for numbers 1 through 8)

**°C#** Segment temperature in °C – Set temperature for a user program. A decimal point will display in lower right corner. (# stands for numbers 1 through 8)

**Edit** Edit the default options (beeping at complete, temperature scale, cone fire, delay, maximum programmable temperature)

**ErrP** There has been a power interruption that has stopped the firing. Press any button to clear.

**FAST** Fast (Heat up or Cool down rate)

**FiRE** Ready to fire current program. Press **START** to begin firing.

**FULL** Beeps continuously at end of firing until a button is pressed.

**HtUP** Heat up rates. **SLO** (Slow), **MEd** (Medium), **FAST** (Fast)

**HLd** Hold or Soak time at peak temperature

**HLd#** Soak time in hours:minutes at a hold temperature. (# stands for numbers 1 through 8)

**IdLE** This shows up when the control is not firing or is not being programmed. Message alternates with the current kiln temperature. Similar to **StOP**.

**It-1** This comes on when you first turn on the control if it is a Cone 10 control.

**LL-6** This comes on when you first turn on the control if

# OPERATION OF L&L KILNS WITH A ONE-TOUCH™ (Deg C)

it is a Cone 6 control.

**MEd** Medium (Heat up or Cool down rate)

**OFF** No beeping when firing is complete. Or could be that an option is off when setting options. Also used to show that Cooling is off.

**On** Beeps for 15 seconds at end of firing.

**rA#** Ramp Number (rate per hour of temperature increase or decrease). (# stands for numbers 1 through 8)

**rStr** Restore default original values

**SEG** Short for Segments. You can enter up to 8 segments in a program.

**SLO** Slow (Heat up or Cool down rate)

**SStP** Skip Step (used to advance to the next ramp)

**StOP** The kiln is at idle and ready to be programmed. Message alternates with the current kiln temperature.

**CUS1, CUS2, CUS3, CUS4** Custom program number displayed.

## 18. ERROR CODES

---

**tC FAIL** **tC** alternating with **FAIL** indicates the thermocouple has failed. Replace the defective thermocouple. To clear the error, press any button.

**Errd** Displayed whenever the kiln temperature is 38°C above the traveling set-point, which is the current desired temperature in the kiln. The traveling set-point will increase or decrease according to the programmed rate.

**Errl** Displayed whenever the kiln temperature is rising during an up ramp slower than 9°C/hr. If this rate continues for 8 minutes the firing will be stopped. **Errl** may be an indication that the elements are worn or that a relay has stopped working.

**ErrP** Displayed whenever there is a power interruption that is long enough to stop the firing. If the power interruption is brief, the kiln will continue to fire when power is restored; in this case, there will be no indication of a power failure. To clear the error, press any button.

**ErrF** Displayed whenever the kiln temperature is decreasing during a down ramp slower than 9°C/hr. If this rate continues for 8 minutes the firing will be stopped. **ErrF** may be an indication that a relay has stuck in the on position.

**tC--** The red and yellow thermocouple wires are reversed.

## 19. SOFTWARE VERSION

---

These instructions apply to software version **LL-G** for the Cone 6 version of the control or **lt-l** for the Cone 10 version of the control. You will see this code flash when you first turn on the control.

## 20. FAHRENHEIT INSTRUCTIONS

---

These instructions are available in a Fahrenheit version. Go to [hotkilns.com/basic-one-touch-f](http://hotkilns.com/basic-one-touch-f)

## 21. SPECIFICATIONS

---

Go to [hotkilns.com/one-touch-specifications](http://hotkilns.com/one-touch-specifications)



**NOTES:**

Control Wire:  
16 AWG, 105°C  
Power Wire:  
10 AWG, 150°C

LOOKING INSIDE CONTROL PANEL

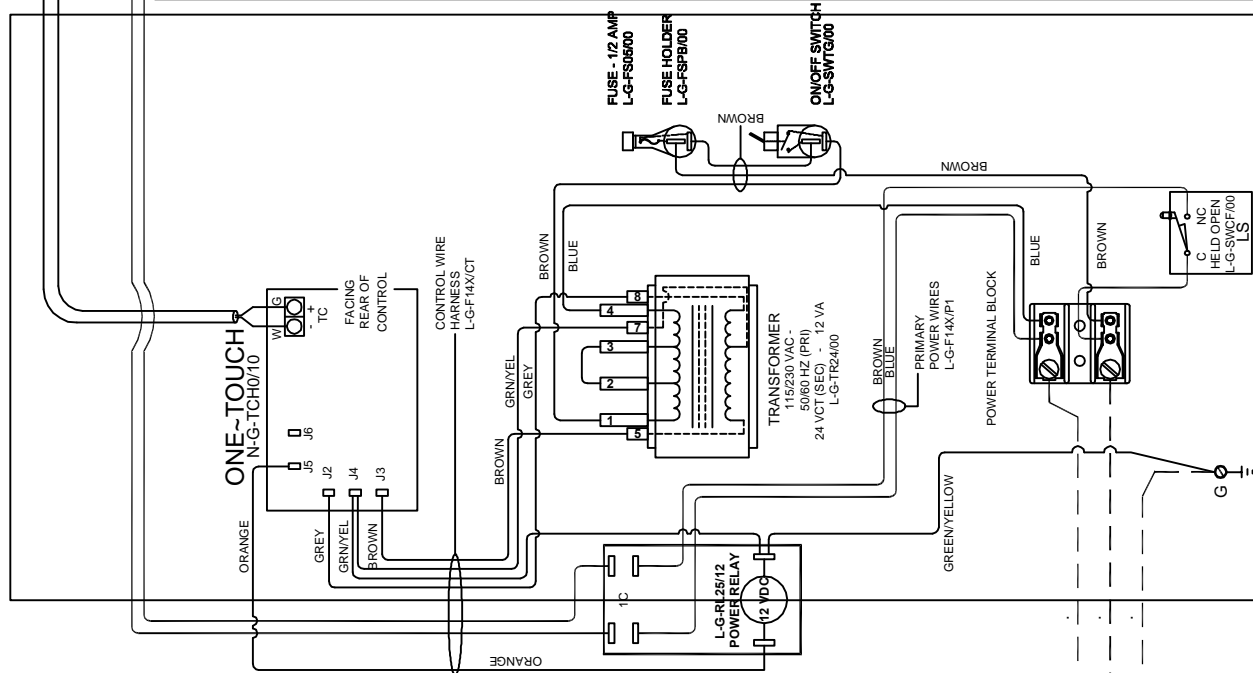

PLUG BY CUSTOMER

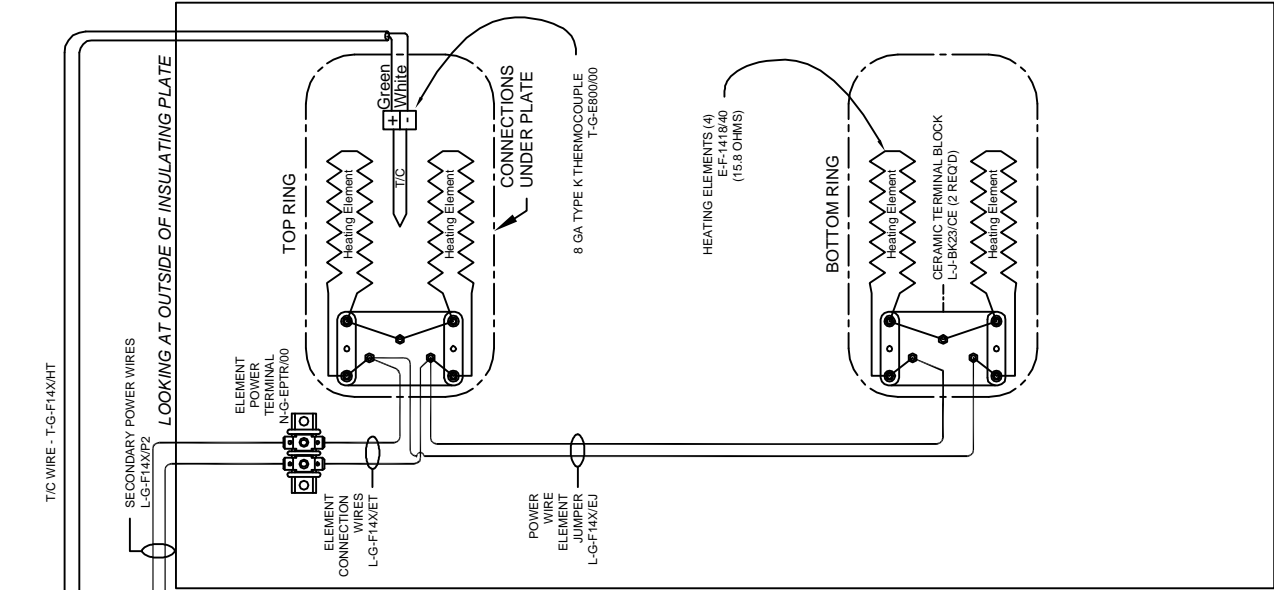
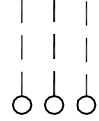

<b>Models F1418-EU-230 AND R1618-EU-230</b>	
VOLTAGE	220-240 / 1 / 50-60
WATTS	~ 3,450
FULL LOAD AMPS	L1   L2   L3 15.0   15.0   X
POWER SUPPLY	FUSE   WIRE 20A   14 AWG
ELEMENTS	QTY   OHMS 4   14.8
<b>Models F1418-UK-230 AND R1618-UK-230</b>	
VOLTAGE	220-240 / 1 / 50-60
WATTS	~ 3,000
FULL LOAD AMPS	L1   L2   L3 13.0   13.0   X
POWER SUPPLY	FUSE   WIRE 20A   14 AWG
ELEMENTS	QTY   OHMS 4   15.8

DRAWING NO.	K220-152	SHEET OF	1/1	REV	E	TITLE	MODELS FUEGO AND ROBIN 1 PHASE KILN WIRING DIAGRAM	SCALE	1 = 8	DATE	10/11/04	DRAWN BY	G.D.L.	FILE NAME	L:\E\LLKILNFUEGO K220-152.DWG	MADE FROM	K220-151.DWG																					
<table border="1"> <tr> <th>REV.#</th> <th>DATE</th> <th>REVISION DESCRIPTION</th> </tr> <tr> <td>E</td> <td>10/11/04</td> <td>ADDED RESISTANCE AND POWER SUPPLY VALUES, CORRECTED WIRING COLORS</td> </tr> <tr> <td>D</td> <td>10/11/04</td> <td>CORRECTED CONTROL INPUTS &amp; WIRINGS</td> </tr> <tr> <td>C</td> <td>03/11/04</td> <td>REPLACED BARTLETT PK CONTROL WITH ONE TOUCH CONTROL, NEW PANEL FOR WIRING</td> </tr> <tr> <td>B</td> <td>03/11/04</td> <td>ADDED MODELS F1418-UK-230 AND R1618-UK-230</td> </tr> <tr> <td>A</td> <td>02/10/04</td> <td>ADDED ROBIN MODEL / MISCELLANEOUS CHANGES</td> </tr> <tr> <td>0</td> <td>03/10/04</td> <td>FIRST ISSUE</td> </tr> </table>																		REV.#	DATE	REVISION DESCRIPTION	E	10/11/04	ADDED RESISTANCE AND POWER SUPPLY VALUES, CORRECTED WIRING COLORS	D	10/11/04	CORRECTED CONTROL INPUTS & WIRINGS	C	03/11/04	REPLACED BARTLETT PK CONTROL WITH ONE TOUCH CONTROL, NEW PANEL FOR WIRING	B	03/11/04	ADDED MODELS F1418-UK-230 AND R1618-UK-230	A	02/10/04	ADDED ROBIN MODEL / MISCELLANEOUS CHANGES	0	03/10/04	FIRST ISSUE
REV.#	DATE	REVISION DESCRIPTION																																				
E	10/11/04	ADDED RESISTANCE AND POWER SUPPLY VALUES, CORRECTED WIRING COLORS																																				
D	10/11/04	CORRECTED CONTROL INPUTS & WIRINGS																																				
C	03/11/04	REPLACED BARTLETT PK CONTROL WITH ONE TOUCH CONTROL, NEW PANEL FOR WIRING																																				
B	03/11/04	ADDED MODELS F1418-UK-230 AND R1618-UK-230																																				
A	02/10/04	ADDED ROBIN MODEL / MISCELLANEOUS CHANGES																																				
0	03/10/04	FIRST ISSUE																																				



**NOTES:**  
 Control Wire:  
 16 AWG, 105°C  
 Power Wire:  
 10 AWG, 150°C

Model	
<b>F1418-220-14A</b>	
VOLTAGE	220 / 1 / 50-60
WATTS	3,080
FULL LOAD AMPS	L1   L2   L3 14.0   14.0   X
POWER SUPPLY	FUSE   WIRE 20A   14 AWG
ELEMENTS	QTY   OHMS 4   15.1

Model	
<b>F1418-220-15A</b>	
VOLTAGE	220 / 1 / 50-60
WATTS	3,300
FULL LOAD AMPS	L1   L2   L3 15.0   15.0   X
POWER SUPPLY	FUSE   WIRE 20A   14 AWG
ELEMENTS	QTY   OHMS 4   14.1

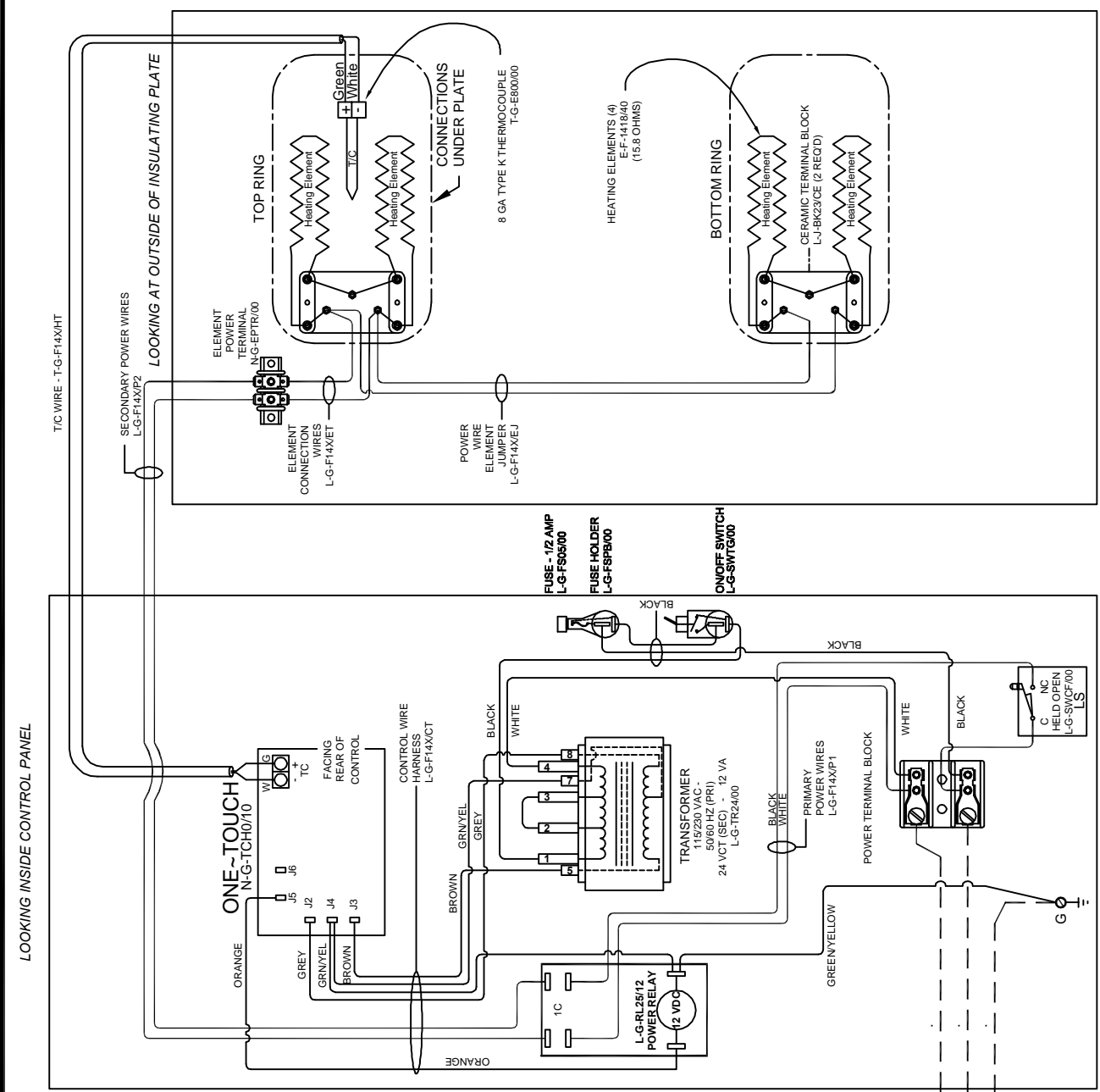

PLUG BY CUSTOMER

REV #	DATE	DESCRIPTION
0	04/03/17	FIRST ISSUE

DRAWING NO.	CH04171	SHEET OF	1/1	REV	0	TITLE	MODELS F1418-220-14A/15A 1 PHASE KILN WIRING DIAGRAM	SCALE	1 = 8	DATE	04/03/17	DRAWN BY	C.H	FILE NAME		MADE FROM	K220-152
-------------	---------	----------	-----	-----	---	-------	---	-------	-------	------	----------	----------	-----	-----------	--	-----------	----------



# ASSEMBLY INSTRUCTIONS FOR L&L FUEGO AND ROBIN KILNS

## TABLE OF CONTENTS

TOOLS NEED FOR THE JOB.....	1
<b>UNPACKING</b> .....	1
Inspect for visible damage .....	1
Remove Top from Carton.....	1
Unpacking the kiln .....	1
<b>ASSEMBLING THE STAND</b> .....	1
<b>LOCATING THE KILN</b> .....	1
<b>SETTING UP THE KILN</b> .....	2
<b>ASSEMBLING WITH TWO PEOPLE</b> .....	3
<b>ASSEMBLING WITH ONE PERSON</b> .....	3
removing the control panel.....	3
<b>DISASSEMBLING THE KILN RINGS</b> .....	5
setting up the kiln .....	6

## TOOLS NEED FOR THE JOB

You will need the following tools for the job:

- 1) Phillips head screw driver (medium size head)
- 2) Knife
- 3) Adjustable Wrench
- 4) 3/8" Nut Driver or socket wrench
- 5) Level (not absolutely necessary)

## UNPACKING

### INSPECT FOR VISIBLE DAMAGE

The carton should arrive without visible damage. If any carton was damaged in transit, you should either refuse shipment or unpack the kiln in the drivers presence in order to file a damage report with the freight company. Call the distributor immediately if there is a problem. **SAVE ALL MATERIALS UNTIL YOU ARE SURE YOU WON'T NEED THEM. AT THE VERY LEAST NOTE DAMAGE ON THE BILL- OF-LADING - WITHOUT THIS YOU HAVE NO PROTECTION!**

### REMOVE TOP FROM CARTON

- 1) Cut the banding around the kiln box.
- 2) With a screw driver pry off the staples holding the top of the box to the box sleeve and remove the top.

## UNPACKING THE KILN

- 1) With a screw driver pry off the staples holding the bottom box tray to the box sleeve.
- 2) Next remove the cardboard inset from the carton, and remove the carton sleeve from the skid.

## ASSEMBLING THE STAND

The stand consists of four legs, the stand base, and eight 1/4-20 bolts. Using the enclosed stand hardware, assemble the kiln stand.

- 1) Assemble the stand legs. **Make sure all the stand legs are tight.** Use a nut driver or an adjustable wrench to do this.

*Each leg gets bolted to the stand with two 1/4-20 bolts provided. They do not need nuts:*



## LOCATING THE KILN

- 1) Place the stand on the floor in the desired location. This should be set so that the outside stainless steel surface of the kiln will be at least 30cm (12") to 45cm (18") from any combustible wall. Floor must be nonflammable.

Information concerning clearances, ventilation and electrical requirements is detailed in the "INSTRUCTIONS" section of this manual. Read now if you are uncertain about any of these issues. **DON'T PROCEED UNTIL YOU ARE COMFORTABLE WITH THE LOCATION THAT YOU SELECT.**

# ASSEMBLY INSTRUCTIONS FOR L&L FUEGO AND ROBIN KILNS

## SETTING UP THE KILN

1) Place the stand in your desired location.

*The stand in position on the floor:*



2) You're now going to build the kiln from the bottom up.

3) **LEVEL THE STAND NOW!** Do this before proceeding because at this point it is easy to put a level on the flat base. Use metal shims under the legs to accomplish the leveling. We suggest using a carpenter's level for this job. Make sure that the stand will not wobble.

*Ensuring that the kiln stand is level when in position.*



## WHY IS LEVELING SO IMPORTANT?

If the stand and the bottom are not level your kiln shelves will not be level and loading will be difficult. Kiln shelves loaded with ceramic ware are like a house of cards to begin with - don't make it any harder!

Also - an uneven floor will quickly become a cracked floor. There should be equal support under each leg of the stand so the floor does not rock back and forth.

Be patient about doing this right as you are assembling the kiln. Once you have put the kiln sections on the bottom of the kiln you will not feel like taking it off - so it is important to have this base be level to start with.

4) Note that the kiln bottom is packed on top of the kiln so it is easily removed first without moving the kiln.

*Removing the bottom from the package.*



5) Place the bottom of the kiln on the kiln stand, making sure to center it on the stand. It is not critical how the polygonal corners are oriented to the square stand.



# ASSEMBLY INSTRUCTIONS FOR L&L FUEGO AND ROBIN KILNS

*The kiln base positioned on the stand.*



## ASSEMBLING WITH TWO PEOPLE

If you have two reasonably strong people available you can lift the whole kiln with the two sections and the top attached without disassembling the panel. (If you have only one person - skip this section and use the single person assembly technique).

**CAUTION:** The two kiln sections and top together of the Robin weigh about 70Kg (150 pounds). Be careful not to strain yourself. The Fuego weighs less and a strong person can probably lift this by themselves.

1) Pick up the kiln using the handles on the bottom section and place it on the bottom slab. Adjust it until the bottom section matches the bottom slab.

***Maneuvering the kiln using the handles on the bottom section.***



2) Your kiln is now fully assembled and ready to operate.

## ASSEMBLING WITH ONE PERSON

### REMOVING THE CONTROL PANEL

1) Remove one of the Cotter Pins from the hinge bar.

***Removing a cotter pin.***



2) Remove the Hinge Bar from the flanges on the control panel and the hinge bracket on the kiln lid.

***Removing the hinge bar.***



3) Set the kiln lid to the side of the top section. There is no need to remove the support chains unless you want to completely remove the kiln lid.



# ASSEMBLY INSTRUCTIONS FOR L&L FUEGO AND ROBIN KILNS

*Offsetting the lid for panel removal.*

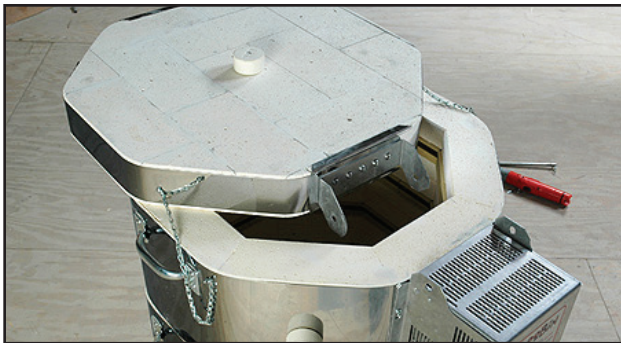

4) Loosen, but do not remove, the mounting screws that hold the control panel to the two kiln rings.

*Unscrewing the mounting screws.*

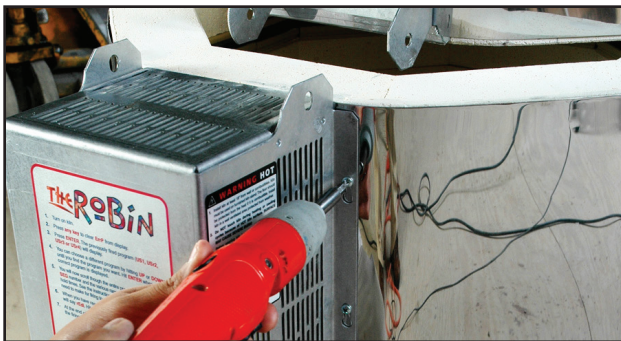

5) Lift the Control Panel up slightly so that the screws on its right side can pass through the keyhole slots.

*Lifting up the control panel.*



6) Swing the Panel out and to the left so that it is still attached to the kiln, yet the right side is open.

*Swinging the control panel to the left.*

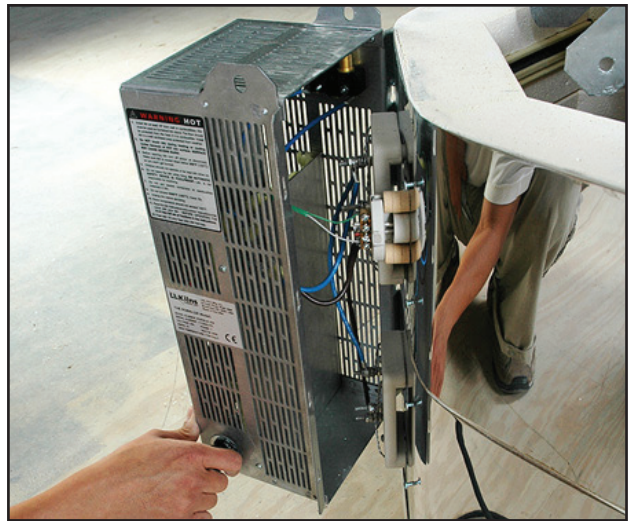

7) Unscrew the Thermocouple Wires.

*Unscrewing the thermocouple wires*



8) Pull the two element connections wires off of the Element Power Terminal.

# ASSEMBLY INSTRUCTIONS FOR L&L FUEGO AND ROBIN KILNS

*Removing the element connection wires.*



9) The Control Panel can now be completely removed from the kiln rings.

*The removed control panel.*

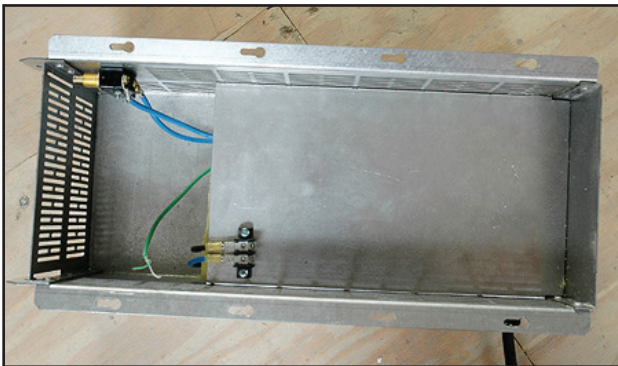

## DISASSEMBLING THE KILN RINGS

1) Using a standard 10mm (3/8") nut driver, remove the nuts on the bottom Element Terminal Block so that the element wires that run between the two kiln sections can be removed. Set the hardware aside.

*Removing the jumper wires from the bottom section.*



2) Remove the top kiln section, with the lid still attached, from the bottom section. Temporarily place it in a stable location.

*Removing the top section along with the lid.*

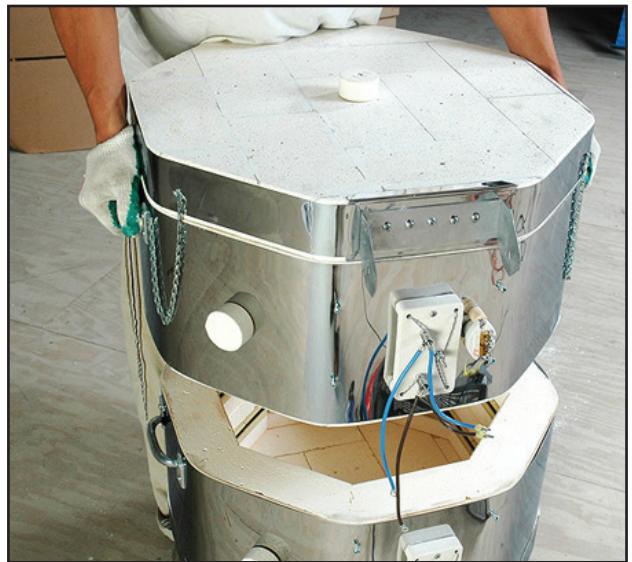

NOTE: Usually the top section with the lid still attached is light enough for one person to move. If you feel uncomfortable with this amount of weight then remove the screws that hold the support chains to the kiln body and move the top separately. Do NOT over-exert yourself.



# ASSEMBLY INSTRUCTIONS FOR L&L FUEGO AND ROBIN KILNS

## SETTING UP THE KILN

1) Remove the bottom kiln section from the packaging and place it on the bottom slab. Adjust it until the section matches the slab.

*Positioning the bottom section on the base.*



2) Place the top section, with the lid still attached, on top of the bottom section. Adjust it until the top section matches the bottom section.

*Positioning the top section and lid on the bottom section.*



3) Reattach the element jumper wires to the bottom Element Terminal Block.

a) If it was taken off, replace the washer that goes between the second nut and the jumper cords.

b) Next the element jumper wires go on, with blue on the top-left terminal bolt and brown on the lower-left terminal bolt.

*How the element terminal blocks with elements, element jumper wires, and power lead wires should be wired.*

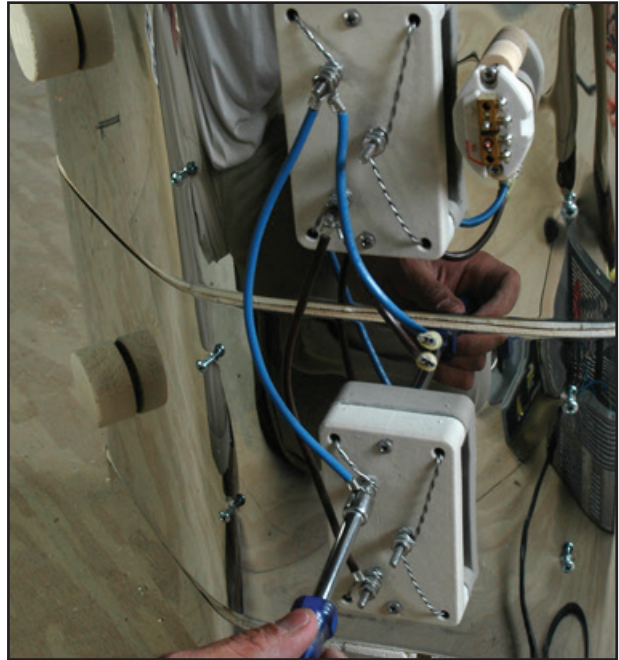

c) Then a washer goes on.

d) Then another nut goes on and gets tightened.

# ASSEMBLY INSTRUCTIONS FOR L&L FUEGO AND ROBIN KILNS

Detail showing how all the hardware gets assembled on the terminal bolt before it is tightened. The white wires shown will be blue.



4) Rehang the Control Panel on the left-most mounting screws so that the panel is swung out to the left.

*The control panel rehung on kiln body.*



5) Reconnect the element connection wires to the Element Power Terminal.

*Reattaching the element connection wires.*

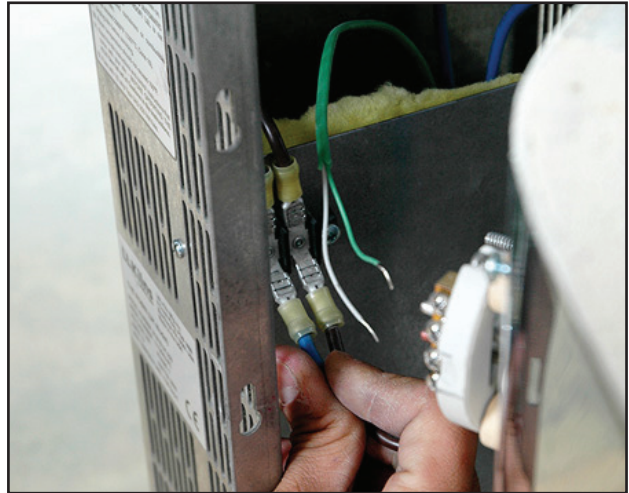

6) Reconnect the thermocouple wire to the Thermocouple. For most Fuegos: Be sure to get Black matched to the Plus (+) sign and the Red matched to the Minus (-) sign. For UK & European Fuegos: Be sure to get Green matched to the Plus (+) sign and the White matched to the Minus (-) sign.

*Tighten screws on thermocouple lead wire.*



NOTE: The terminals on the control are painted RED for negative (-) and YELLOW for positive (+). For UK & European Fuegos: Be sure to get Green matched to the Plus (+) sign and the White matched to the Minus (-) sign.



# ASSEMBLY INSTRUCTIONS FOR L&L FUEGO AND ROBIN KILNS

7) Push the right side of the panel flush with the kiln body and slide the mounting screws through the keyhole slots.

**Reattaching the right side of the control panel.**



8) Ensure that the top of the panel is flush with the top of the firebrick. Tighten all of the mounting screws.

**Ensuring that the control panel is flush.**



9) Reinsert the Hinge Bar through the control panel flanges and the lid mounting bracket.

**Reinserting the hinge bar.**



10) Reinsert the Cotter Pin into the hinge bar.

**Reinserting the cotter pin.**



11) Your kiln is now fully assembled and ready to operate.



# FUEGO - ROBIN PANEL PHOTO

## Photo of inside a Fuego or Robin control panel

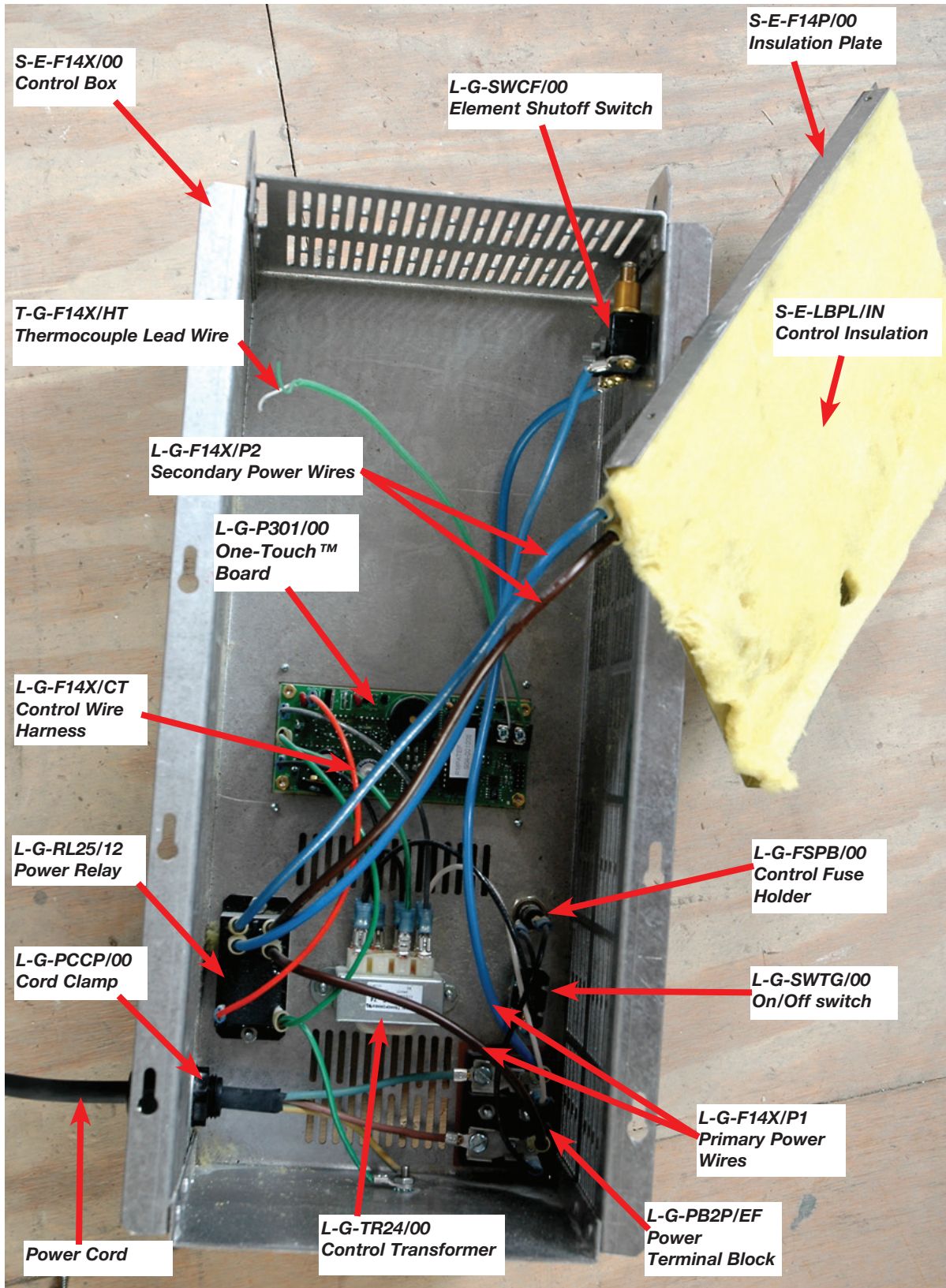

# TROUBLESHOOTING AND REPAIR INSTRUCTIONS FOR L&L KILNS

## TABLE OF CONTENTS

<b>TROUBLESHOOTING GUIDE</b> .....	<b>2</b>
<b>VIDEOS</b> .....	<b>2</b>
<b>TROUBLESHOOTING WEB TOOLS</b> .....	<b>2</b>
<b>RELATED L&amp;L GUIDES</b> .....	<b>2</b>
CAUTION INSTRUCTIONS .....	2
REGULAR KILN MAINTENANCE .....	2
BASIC ELECTRICITY FOR TROUBLESHOOTING .....	2
TROUBLESHOOTING BRICK PROBLEMS .....	2
TROUBLESHOOTING ELEMENT PROBLEMS .....	3
TROUBLESHOOTING FIRING PROBLEMS WITH CONE PACKS .....	3
THE CERAMIC PROCESS .....	3
REPLACEMENT PARTS .....	3
SERVICE .....	3
<b>GENERAL TROUBLESHOOTING TOOLS AND METHODS</b> .....	<b>3</b>
BASIC TOOLS REQUIRED .....	3
<b>KEYS TO GOOD TROUBLESHOOTING</b> .....	<b>3</b>
SAFETY FIRST .....	3
DEFINE THE VARIABLES .....	3
ELIMINATE VARIABLES ONE AT A TIME .....	3
<b>Err1 (ERROR 1) - THE MOST COMMON ERROR</b> .....	<b>3</b>
<b>CONTROL DISPLAY DOESN'T SHOW ANYTHING</b> .....	<b>3</b>
On/Off Switch .....	3
Fuse .....	3
Fuse Holder .....	3
On/Off Switch .....	4
Plug & Cord (if you have one) .....	4
Circuit Breaker / Power Source .....	4
Control Transformer .....	4
Control Board .....	5
Internal Wiring .....	5
Short Circuits .....	5
<b>EASY-FIRE DISPLAY READS FAIL</b> .....	<b>5</b>
<b>EASY-FIRE DISPLAY READS 2400 or CPLt WHEN IT STARTS UP</b> .....	<b>6</b>
<b>ONE-TOUCH CONTROL DISPLAY READS FAIL</b> .....	<b>6</b>
<b>DISPLAY IS NORMAL BUT KILN WON'T HEAT UP</b> .....	<b>7</b>
Programming .....	7
Wiring .....	7
EASY-FIRE Control Board Outputs .....	7
ONE-TOUCH Control Board Outputs .....	7
Bad Power Relays .....	7
Bad Elements .....	7
Run a Simple Paper Test .....	7
<b>KILN FIRES UNEVENLY</b> .....	<b>7</b>
Peepholes .....	7
Lid Seal .....	7
Elements .....	8
Loading .....	8
Firing with Cones .....	8
EASY-FIRE Thermocouple Offsets .....	8
ONE-TOUCH Thermocouple Offsets .....	8
Vent System .....	9
<b>KILN FIRES TOO HOT OR COLD</b> .....	<b>9</b>
Firing with Cones .....	9
Easy-Fire vs Vary-Fire (on DynaTrol) .....	9
Be Careful with Hold Times .....	9
Control Settings .....	9
Thermocouple Drift .....	9
<b>KILN STALLS</b> .....	<b>9</b>
<b>KILN FIRES SLOWLY - BOTH SERIES</b> .....	<b>10</b>
Run a Simple Paper Test .....	10
Bad or Wrong Voltage .....	10
Element Aging .....	10
Power Relays .....	11
Bad Wiring .....	11
Wiring in the Kiln .....	11
Element Connections .....	12

Heat Leakage & Vents .....	12
Adding More Insulation .....	12
<b>KILN FIRES SLOWLY - EASY-FIRE</b> .....	<b>12</b>
Single vs Three Zone Control .....	12
ShtO (SHUT-OFF) SETTING .....	13
Pld SETTING .....	13
Change elements to graded elements .....	13
<b>KILN HEATS TOO FAST</b> .....	<b>13</b>
Relays .....	13
Voltage .....	13
Elements .....	13
<b>EASY-FIRE ERROR MESSAGES</b> .....	<b>14</b>
Errd .....	14
Err1 .....	14
Err2 .....	15
Err3 .....	15
Err4 .....	15
Err5 .....	15
Err6 .....	15
Err7 .....	15
Err8 .....	15
ErrP + PF .....	15
Err- .....	15
FAIL .....	15
Turning Error Codes On or Off .....	16
Can you restart the kiln after it stops because of Error Codes? .....	16
Worst Case Scenario for Restarting After an Error Code .....	16
<b>ONE-TOUCH ERROR MESSAGES</b> .....	<b>17</b>
Errd .....	17
Err1 .....	17
ErrP .....	18
ErrF .....	18
tC- .....	18
FAIL .....	18
Can you restart the kiln after it stops because of Error Codes? .....	18
Worst Case Scenario for Restarting After an Error Code .....	18
<b>SERVICE FOR YOUR KILN</b> .....	<b>19</b>
WHERE TO GET SERVICE .....	19
WHERE TO BUY PARTS .....	19
REPLACEMENT ELEMENTS .....	19
<b>REMOVING PANEL FOR SERVICE</b> .....	<b>19</b>
<b>REPLACING DYNATROL</b> .....	<b>20</b>
<b>REPLACING ONE-TOUCH™</b> .....	<b>20</b>
<b>REPLACING TRANSFORMER</b> .....	<b>21</b>
<b>REPLACING POWER RELAYS</b> .....	<b>21</b>
<b>REPLACING FUSE HOLDER</b> .....	<b>21</b>
<b>REPLACING THERMOCOUPLES</b> .....	<b>22</b>
<b>CHECKING ELEMENT OHMS</b> .....	<b>22</b>
<b>Element Ohm Charts</b> .....	<b>22</b>
Easy-Fire Element Ohm Chart .....	22
School-Master Top Element Ohm Chart .....	23
School-Master Bottom Element Ohm Chart .....	23
<b>CHANGING ELEMENTS</b> .....	<b>23</b>
SEE THESE VIDEOS FIRST .....	23
<b>REPLACING ELEMENT HOLDERS</b> .....	<b>23</b>
<b>CRACKS IN THE LID &amp; BOTTOM</b> .....	<b>23</b>
<b>TIGHTENING STAINLESS BANDS</b> .....	<b>23</b>
<b>REPLACING FIREBRICK IN SIDES</b> .....	<b>23</b>
<b>DRILLING OUT HOLES FOR PEEPHOLES</b> .....	<b>24</b>
<b>DRILLING OUT FOR ELEMENT CONNECTIONS</b> .....	<b>24</b>
<b>REPLACING BOTTOMS</b> .....	<b>24</b>
<b>REPLACING LIDS</b> .....	<b>24</b>
<b>MORE ABOUT TROUBLESHOOTING CERAMIC PROBLEMS</b> .....	<b>24</b>
<b>Photo of a 1-phase control panel for a three section Easy-Fire kiln</b> .....	<b>25</b>

# TROUBLESHOOTING AND REPAIR INSTRUCTIONS FOR L&L KILNS

## CAUTION - ELECTRICITY CAN KILL

Many of the tests described in here are performed under power. They should be done ONLY by someone who is familiar with electrical safety such as an electrician or trained maintenance person. We identify any test that is live with a CAUTION statement. We describe these tests in detail so that an electrically trained person who doesn't specifically understand kilns can do the troubleshooting - the level of simplicity described is not meant as an invitation to harm the untrained. AS LONG AS THE KILN IS UNPLUGGED YOU ARE SAFE.

## GET A DIGITAL MULTIMETER!

If you want to do much of the troubleshooting described here and not be dependent on a kiln service person then get this tool. It is not hard to use! Without it you are only guessing at the origin and severity of an electrical problem based on how the kiln is acting. A slow-firing kiln may just have old elements, or the elements could be fine but the incoming voltage from your power supply could be low, or fluctuating. Unless you test with a multimeter, you could purchase new elements and run the risk that you might be wasting money and time without solving the problem. Be forewarned however: Testing electrical circuits is very dangerous and potentially deadly if you do it incorrectly. It could result in electrocution! If you don't feel comfortable doing this hire an electrician or get someone to do it who is qualified. That being said - many of the tests described in here just require testing for resistance - which is done with the kiln unplugged. **AS LONG AS THE KILN IS UNPLUGGED YOU ARE SAFE.**

You can buy an inexpensive digital multimeters for around \$40-\$50. The meter you buy should be digital simply because the analog type is not very accurate. **You must be able to see ohm (resistance) readings to the first decimal place.**

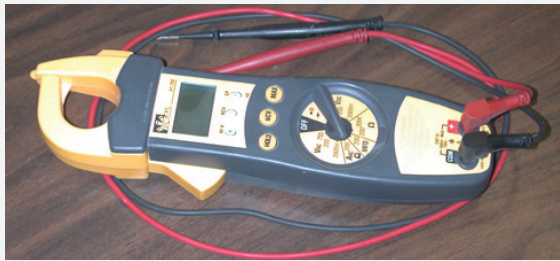

## TROUBLESHOOTING GUIDE

This manual is meant to assist and educate kiln owners and service technicians. Our basic philosophy at L&L is to make kilns that last. No small part of having a reliable well-firing kiln is good maintenance. This information is provided as a service and is believed to be accurate. However, it is the reader's sole responsibility to interpret and use this information correctly. Please visit our web site to download the latest versions of all our instructional and technical information.

## VIDEOS

ALSO WE ENCOURAGE YOU TO USE THE VIDEOS ON OUR WEB SITE ([hotkilns.com/video](http://hotkilns.com/video)).

## TROUBLESHOOTING WEB TOOLS

The latest troubleshooting information is on the web. This is constantly updated. See [hotkilns.com/knowledgebase](http://hotkilns.com/knowledgebase)

## RELATED L&L GUIDES

### CAUTION INSTRUCTIONS

See CAUTION INSTRUCTIONS FOR L&L KILNS in the CAUTIONS section of your Instruction Manual. THIS IS SOMETHING YOU MUST READ. (Also [hotkilns.com/cautions](http://hotkilns.com/cautions))

### REGULAR KILN MAINTENANCE

See REGULAR MAINTENANCE OF YOUR L&L KILN in the MAINTENANCE section of your Instruction Manual. THIS IS SOMETHING YOU MUST READ.

### BASIC ELECTRICITY FOR TROUBLESHOOTING

See BASIC ELECTRICITY FOR TROUBLESHOOTING KILNS in the TROUBLESHOOTING section. Also see [hotkilns.com/volts.pdf](http://hotkilns.com/volts.pdf) for more in-depth information about electricity for kilns.

### TROUBLESHOOTING BRICK PROBLEMS

See TROUBLESHOOTING AND FIXING BRICK PROBLEMS in the TROUBLESHOOTING section for information on firebrick problems and instructions on how to repair firebrick problems.



# TROUBLESHOOTING AND REPAIR INSTRUCTIONS FOR L&L KILNS

## TROUBLESHOOTING ELEMENT PROBLEMS

See ELEMENT TROUBLESHOOTING & INSTALLATION INSTRUCTIONS in the TROUBLESHOOTING section for information on elements problems and instructions on how to install elements and element holders.

## TROUBLESHOOTING FIRING PROBLEMS WITH CONE PACKS

See TROUBLESHOOTING KILN FIRING WITH CONE PACKS in the LOG, CONES, TIPS section.

## THE CERAMIC PROCESS

See THE CERAMIC PROCESS in the LOG, CONES, TIPS section.

## REPLACEMENT PARTS

See the PARTS section.

## SERVICE

See SERVICE section.

## GENERAL TROUBLESHOOTING TOOLS AND METHODS

### BASIC TOOLS REQUIRED

The minimal toolkit necessary for effective troubleshooting and fixing of electric kilns contains a digital multi-meter to measure ohms and AC voltage, and an assortment of screwdrivers, nutdrivers, wrenches, pliers, cutters, wire strippers and wire terminal crimpers. As you work on your kiln you will see what types of tools you need, like a 3/8" nut-driver, needle-nose pliers without the cutting part so the tips will close all the way. wire cutters heavy enough to cut the element terminals, wire strippers and wire terminal crimpers. No special tools are required for maintenance on L&L kilns.

## KEYS TO GOOD TROUBLESHOOTING

### SAFETY FIRST

Pay attention to electrical safety. Don't get electrocuted and don't guess.

### DEFINE THE VARIABLES

Define all variables of the situation, and how they could potentially interact with and affect each other in each unique case you come across.

## ELIMINATE VARIABLES ONE AT A TIME

Eliminate variables one by one to expose the problem variable(s). Asking questions can do this to some degree. Electrical testing, examining shards of ware or cone, or examining the interior of the kiln usually can supply the rest of the story. Good troubleshooting is based on logic.

## Err1 (ERROR 1) - THE MOST COMMON ERROR

This is the most common troubleshooting problem we see. It generally means one of two things. 1) The elements have aged with increased resistance and therefore lower power. 2) A relay is not working. See The section in these instructions on Error Codes, CHECKING ELEMENT OHMS, and various paragraph on checking the relays.

## CONTROL DISPLAY DOESN'T SHOW ANYTHING

### On/Off Switch

1) Make sure the On/Off Switch is turned on. Turn it on and off.

### Fuse

1) Check control fuse in side of control box. Twist open the fuse holder and physically check the fuse. If the metal element inside is melted if it is blown. You can also use your digital multi-meter to check continuity across the fuse. Replace if faulty: [hotkilns.com/control-panel-fuse](http://hotkilns.com/control-panel-fuse)

*Picture of the on/off switch and fuse holder opened.*



### Fuse Holder

If you notice that the fuse holder itself is damaged replace it. See: [hotkilns.com/change-fuse-holder](http://hotkilns.com/change-fuse-holder)

# TROUBLESHOOTING AND REPAIR INSTRUCTIONS FOR L&L KILNS

## On/Off Switch

The on/off switch rarely needs replacing but if you have to replace that see this video: [hotkilns.com/replace-on-off-switch](http://hotkilns.com/replace-on-off-switch)

## Plug & Cord (if you have one)

1) Make sure the power cord is plugged into the receptacle. Reseat plug. Make sure it is held firmly and that the springs inside the receptacle seem to be working.

2) With power off examine the electrical cord. Look for burned or melted areas and breaks or pinched sections. Look closely at the head of the plug. If there is an internal problem with the wires and the plug parts you won't be able to see it but you may detect a softening or melting of the plastic at the plug head. Look for oxidation or substantial discoloration or even burnt spots on the prongs. Replace plug and cord if this is questionable.

3) With power turned on and panel open check voltage at the Power Terminal Block. If you see no voltage there then you know something is wrong with the power source.

**CAUTION:** This test should only be done by an experienced person familiar with electricity and its dangers.

If you have to replace the power cord see this video. It includes video of changing a power cord. [hotkilns.com/change-phase-easy-fire](http://hotkilns.com/change-phase-easy-fire)

## Checking voltage at the power terminal block.

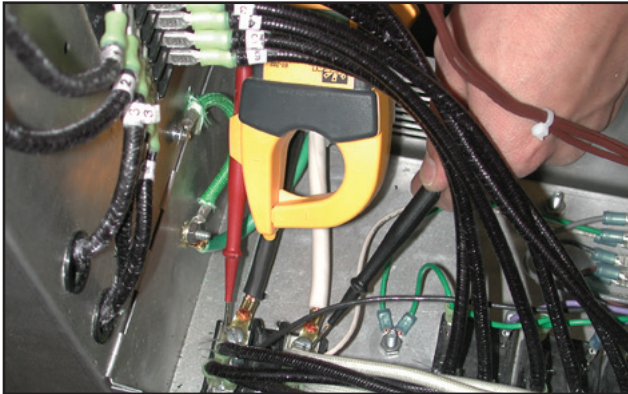

## Circuit Breaker / Power Source

1) Check voltage at the receptacle. **CAUTION:** This test should only be done by an experienced person familiar with electricity and its dangers.

## A fused disconnect switch.



2) Check circuit breaker or fused disconnect switch to make sure they are turned on. Sometimes circuit breakers need to be turned on and off to reset them.

3) If you have a fused disconnect check the fuses with your voltmeter for continuity. **CAUTION: This test should only be done by an experienced person familiar with electricity and its dangers.**

4) Make sure fuses or circuit breaker are the proper amperage and type. See wiring diagram for details.

5) Test for voltage at the main power supply as close to the kiln as possible. **CAUTION: This test should only be done by an experienced person familiar with electricity and its dangers.**

## Control Transformer

See this video: [hotkilns.com/check-control-transformer](http://hotkilns.com/check-control-transformer) and [hotkilns.com/change-transformer](http://hotkilns.com/change-transformer).

1) If none of these solve the problem then you could have a bad control transformer. To check the transformer operation test with your digital multimeter. It should read 240 (or 208) volts across terminals 1 & 4 (black and white wires) and 24 volts across terminals 5 & 8 (where the gray and brown wires come out). This is a live test so be very careful not to touch any of the wires - remember there is 240 volts in the panel and this can electrocute you. See photo below. If you are receiving 240/208 Volts in, but not getting the proper approximate 24 Volts out, then you need to replace the control transformer. See: [hotkilns.com/control-transformer-12-va](http://hotkilns.com/control-transformer-12-va)

2) If there is no voltage coming into terminals 1 & 4, white & black, then test for it at the Power Terminal Block where the power cord comes in. If there is power there then look for a bad connection or wire between the power connection block and the transformer, i.e. a bad toggle switch, wire, or ½ amp



# TROUBLESHOOTING AND REPAIR INSTRUCTIONS FOR L&L KILNS

fuse holder. If power is not there then go further back on the line and measure the voltage. Keep going until you find voltage, then look for the problem between that point with the voltage and the last point checked that had no voltage.

## Control Board

1) If the transformer is OK and you know you have voltage going to the control board but the control still shows no display then the control board needs to be replaced.

DynaTrol: [hotkilns.com/dynatrol-control-board](http://hotkilns.com/dynatrol-control-board)

Genesis: [hotkilns.com/genesis-control-board](http://hotkilns.com/genesis-control-board)

One-Touch for School-Master kilns: [hotkilns.com/one-touch-control-board-cone-6](http://hotkilns.com/one-touch-control-board-cone-6)

One-Touch for Doll, Liberty-Belle and Fuego kilns: [hotkilns.com/one-touch-control-board-cone-10](http://hotkilns.com/one-touch-control-board-cone-10)

See this for how to replace: [hotkilns.com/replace-dynatrol](http://hotkilns.com/replace-dynatrol)

## Internal Wiring

1) Unplug kiln or turn off at circuit breaker or fused disconnect and open up panel. CHECK VOLTAGE TO BE SURE. Make sure that all the wires inside the control panel are connected. See photograph on page 2 or page 3 and also the Wiring Diagram. Specifically look at the wires that go from the power connection block to the on/off switch, then to the control fuse and then to the control transformer.

## Short Circuits

Do all the following with the kiln unplugged.

1) Check for short circuits. Look for any signs of burnt wires. This might indicate a short circuit. A way this might happen, as an example, is that frayed wires at the end of a wire connector might touch each other.

2) Check for worn wires that may have shorted against the case. Examine wire insulation. If the wire insulation has become frayed the wires could short to the metal casing which is electrically grounded.

3) Look for dirt. Some dirt (such as carbon compounds) are electrically conductive. This is generally not the case with ceramic materials but some can be. Vacuum out if you see dirt.

NOTE: Usually a short circuit will trip either the circuit breaker for the kiln or the fuses in the fused disconnect switch, if you have one. You will then not see any display on the DynaTrol. Turn your circuit breaker on and off, and check fuses on the fused disconnect and control fuse.

**CAUTION:** These tests should only be done by an experienced person familiar with electricity and its dangers.

## Checking output of the Control Transformer (DANGER-live test).

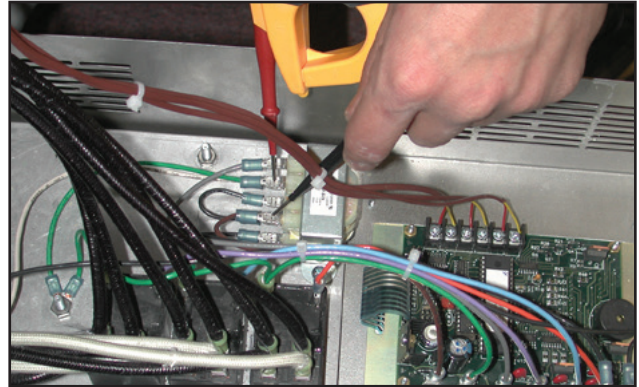

## EASY-FIRE DISPLAY READS FAIL

Usually **FAIL** will be seen flashing along with a **tC1**, **tC2** or **tC3** indicating which thermocouple circuit has failed.

Typically this will just mean that your thermocouple(s) need replacing. Overtime the thermocouple tip will corrode and cause a circuit to **FAIL**. We recommend replacing all thermocouples simultaneously rather than as they fail.

See this to replace thermocouple: [hotkilns.com/change-thermocouple](http://hotkilns.com/change-thermocouple)

1) Unplug the kiln. Open the Control Panel. Remove the offending thermocouples connection wires from the Thermocouple Terminal Strip and bind the red and yellow wires together with electrical tape. Close up the panel and plug in the kiln. The control should read room temperature for that thermocouple (approximately 90 Deg F because of the thermocouple offsets).

2) If it does read room temperature then the thermocouple is probably bad and needs to be replaced. If the control does not read room temperature then there is either a bad thermocouple wire in the Control Thermocouple Harness or the control is bad.

3) Redo the test by putting a small jumper like a paperclip across the thermocouple terminals directly on the DynaTrol board. If the control now will read room temperature then you have a bad thermocouple wire. If it does not read room temperature then the control is definitely bad and needs to be replaced. See this: [hotkilns.com/replace-dynatrol](http://hotkilns.com/replace-dynatrol)

# TROUBLESHOOTING AND REPAIR INSTRUCTIONS FOR L&L KILNS

## EASY-FIRE DISPLAY READS 2400 or CPLt WHEN IT STARTS UP

Even though you know the kiln is not that hot. This indicates thermocouple circuit failure.

**TECHNICAL NOTE:** This is called thermocouple upscale protection. If the control senses a lack of millivoltage (an open circuit) it interprets this as the highest temperature the control could reach. This automatically ensures that the control will not call for power.

1) Check thermocouple end. Examine end carefully. Sometimes there can be a crack that opens up while the kiln is hot but appears to be normal when the kiln is cold. If the end of the thermocouple looks severely corroded and you are getting Error codes then it is best to replace the thermocouple. NOTE: You have to open up the Element Cover Box and remove the thermocouples to check the ends.

*A thermocouple end that will still work but is getting close to creating a problem.*



2) Check thermocouple circuit. For instance check to make sure that all the thermocouple lead wires are firmly connected to the Thermocouple Terminal Strip. Check where the thermocouple lead wires go into the ends of the thermocouples. Are the wires loose? Tighten the screws on the ends of the thermocouples to be sure you have a tight connection. Check for corrosion. Check where the thermocouples connect to the DynaTrol. Try pulling off each connection and reseating it. This can scrape away corrosion that may have built up. Check for melted wires inside the Element Cover Box.

3) A very easy check is to check resistance (ohms) right on the Thermocouple Terminal Strip. Unplug kiln or disconnect from live power by turning off circuit breaker or fused disconnect switch. Open panel. You don't even have to remove the thermocouple wires. Just touch the terminal strip itself with your probes (terminals #1 & #2 for TC1, terminals #3 & #4 for TC2 and terminals #5 & #6 for TC3). If the thermocouples and circuit is normal then you will see a

resistance of about .9 or 1.0. If you see an **OL** in your meter then you have an open circuit somewhere which is probably a bad thermocouple.

4) If you have a bad thermocouple replace it with a new one. Although you may be able to "make it work" by twisting the ends of the wire together this could easily fail during an important load and could also be extremely inaccurate.

## ONE-TOUCH CONTROL DISPLAY READS FAIL

Usually **FAIL** will be seen flashing along with a **tC** indicating the thermocouple has failed.

1) Check thermocouple end. Examine end carefully. Sometimes there can be a crack that opens up while the kiln is hot but appears to be normal when the kiln is cold. If the end of the thermocouple looks severely corroded and you are getting Error codes then it is best to replace the thermocouple. NOTE: You have to open up the Element Cover Box and remove the thermocouple to check the end.

See this to replace thermocouple: [hotkilns.com/change-thermocouple](http://hotkilns.com/change-thermocouple)

2) Check thermocouple circuit. For instance check to make sure that all the thermocouple lead wires are firmly connected to the Thermocouple Terminal Strip. Check where the thermocouple lead wires go into the ends of the thermocouples. Are the wires loose? Tighten the screws on the ends of the thermocouples to be sure you have a tight connection. Check for corrosion. Check where the thermocouples connect to the DynaTrol. Try pulling off each connection and reseating it. This can scrape away corrosion that may have built up. Check for melted wires inside the Element Cover Box.

3) A very easy check is to check resistance (ohms) right on the Thermocouple Terminal Strip. Unplug kiln or disconnect from live power by turning off circuit breaker or fused disconnect switch. Open panel. You don't even have to remove the thermocouple wires. Just touch the terminal strip itself with your probes (terminals #1 & #2 for TC1, terminals #3 & #4 for TC2 and terminals #5 & #6 for TC3). If the thermocouples and circuit is normal then you will see a resistance of about .9 or 1.0. If you see an **OL** in your meter then you have an open circuit somewhere which is probably a bad thermocouple.

4) If you have a bad thermocouple replace it with a new one. Although you may be able to "make it work" by twisting the ends of the wire together this could easily fail during an important load and could also be extremely inaccurate.

# TROUBLESHOOTING AND REPAIR INSTRUCTIONS FOR L&L KILNS

## DISPLAY IS NORMAL BUT KILN WON'T HEAT UP

### Programming

1) Make sure you have programmed the kiln properly and it is supposed to be firing. Do you have a **Delay Time** or a **Preheat Time** in your program? (Hit the **Review Prog** button on the Easy-Fire or hold down the **Custom/Review** button on the School-Master to find out).

### Wiring

1) Unplug kiln or disconnect from live power by turning off circuit breaker or fused disconnect switch. Open panel. Check all power wires for firm connections. Using your multimeter set on resistance you can check continuity of each element circuit by placing the probes on each set of outputs on each Power Relay or right at the Power Terminal Strip (as shown below).

*Picture showing a Multimeter testing for continuity in an element circuit.*



2) Visually inspect the power wires coming from the Power Terminal Block to the inputs of the Power Relays. Reseat all the spade connectors to rub off any oxides and to ensure a good connection.

### EASY-FIRE Control Board Outputs

1) It is possible that the internal switches on the DynaTrol control board could be bad. You can test that by checking to see if you find voltage (12 volts DC) between any of the output contacts on the control board (where the orange, blue and purple wires come out) to ground (any green wire). CAUTION: This test should only be done by an experienced person familiar with electricity and its dangers. See this video: [hotkilns.com/check-switches-dynatrol](http://hotkilns.com/check-switches-dynatrol)

### ONE-TOUCH Control Board Outputs

1) It is possible that the internal switches on the One-Touch™ control board could be bad. You can test that by checking to see if you find voltage (12 volts DC) between

the output contacts (AC1 & AC2 marked on the control board) to ground (any green wire). CAUTION: This test should only be done by an experienced person familiar with electricity and its dangers.

### Bad Power Relays

See this video: [hotkilns.com/checking-relay](http://hotkilns.com/checking-relay) and [hotkilns.com/change-relay](http://hotkilns.com/change-relay)

1) You should be able to hear contactors going on and off with a soft clicking noise when you first turn on the kiln and it is supposed to be heating up. If not try turning the kiln off and then back on again and restarting the program. Of course if you don't hear the relays it only tells you that they aren't firing. The problem could be in the control for instance not telling the relays to fire. If you do hear relays and the kiln is not heating then you know the problem is in the power circuit AFTER the relays.

2) With power on and panel open check voltage before and after each of the contactors while the kiln is firing. CAUTION: This test should only be done by an experienced person familiar with electricity and its dangers.

### Bad Elements

See next section.

### Run a Simple Paper Test

This will tell you if all kiln sections are firing. If they are not it could be a bad relay or maybe a bad internal switch on the control.

1. Place a little piece of paper in each element.
2. Then run a Fast Glaze (or turn the manual switches to Hi on a manual kiln) while you watch the papers.
3. They begin to smolder in about 2 minutes. After 3 or 4 minutes shut the kiln off.
4. This shows you if the elements are operating (or which ones are and which ones are not).

## KILN FIRES UNEVENLY

### Peepholes

1) Plug up Peephole holes in the kiln to prevent drafts.

### Lid Seal

1) Check to make sure that door/lid is sealing properly. If door/lid is not sealing against top brick correctly a bright red glow will be visible around the door/lid seal when kiln is operating. (A little of this is OK). Also excessive heat loss can be felt around seal. Rub seal high points down with



# TROUBLESHOOTING AND REPAIR INSTRUCTIONS FOR L&L KILNS

sandpaper until no more than 1/16 of an inch gap is found at any point along seal. Note that the gap at the top will definitely appear larger than any gap you see between the kiln sections. This is partly because the lid actually bows down in the center of the lid when it heats up and the edges consequently rise slightly. Just check for an UNEVENNESS in this gap which will cause an excessive heat loss.

2) If door/lid is excessively cracked or worn or has holes in it this may cause drafts in the kiln. Replace lid.

See the TROUBLESHOOTING AND FIXING BRICK PROBLEMS section in the TROUBLESHOOTING tab of your instruction manual or [hotkilns.com/brick-troubleshooting](http://hotkilns.com/brick-troubleshooting)

## Elements

1) Elements may have differentially changed in resistance which will also have an effect on uniformity. The three zone control mostly compensates for this but there are limits. Check element resistance (see section at end of this Troubleshooting Guide called "CHECKING ELEMENT OHMS").

2) Empty the kiln. Then turn kiln on using a fast program like FAST GLAZE until elements are red. Open the door carefully and observe the elements to see if they all seem to be glowing about the same amount. CAUTION: The power does not turn off when you open the lid. Be careful not to put your hand inside the kiln while it is on. Dangerous electric shock could result if you touch an element.

## RUN AN EASY-FIRE DIAGNOSTIC

There is a useful diagnostic program within the DynaTrol on Easy-Fire Kilns. This is handy to use when your kiln is first delivered and set up to make sure it was done properly. It can also be useful in seeing if an element has burned out. To use this diagnostic program enter the following sequence when the display says IdIE.

1) Press **OTHER, 4, 4, 3**.

2) Keep pressing **OTHER** to cycle through the menu options until you get to **dIAG** and then press **ENTER**.

3) Open the lid of your kiln. You will see each zone of the kiln turn on for one minute each, starting with zone #1, the top zone. The control will display **Out1**, then **Out2**, then **Out3** as it cycles through this sequence. **CAUTION: The power does not turn off when you open the lid. Be careful not to put your hand inside the kiln while it is on. Dangerous electric shock could result.** This will tell you if the kiln sections are in the wrong order or if the wires are somehow crossed in the control panel. If this is the case the zones will not turn on in the proper 1, 2, 3, order.

## Loading

The Dynamic Zone Control of the EASY-FIRE kilns can compensate for many uneven loading situations. The SCHOOL-MASTER kilns, however, do not employ Zone Control so pay particularly close attention to the following steps.

1) If you are having a problem with uneven firing try to vary the way you load it to match the firing characteristics of the kiln. For instance if it typically fires hot at the top then put more weight in the top to absorb that heat. You can discern how your kiln fires in each section by using cones.

2) Be sure to put posts under the bottom shelf. The bottom shelf should be at least 1/2" to 1-1/2" above the floor of the kiln.

## Firing with Cones

1) Run an empty kiln with three cone packs top- middle - bottom. This will tell you if the load contributes to the problem.

2) Try using cone packs in all sections (top, center, bottom) of the kiln during loaded firings and keep records of what happens. See the TROUBLESHOOTING KILN FIRING WITH CONE PACKS in the LOG, CONES, TIPS, CERAMIC PROCESS tab or [hotkilns.com/troubleshooting-cones](http://hotkilns.com/troubleshooting-cones).

## EASY-FIRE Thermocouple Offsets

Thermocouples can drift in their accuracy over time and this can happen at different rates for each thermocouple. If one thermocouple reads at a different temperature than another thermocouple this can cause unevenness in the kiln. You may need to adjust the offsets to trick the kiln into firing hotter or cooler in certain zones. Read about Thermocouple Offset in section 9.9 of the DYNATROL 700 INSTRUCTIONS FOR L&L KILNS in the CONTROL section of the Instruction Manual and the and the CALIBRATING THE CONTROL section in the BASIC OPERATION OF L&L KILNS WITH A DYNATROL 700 in the OPERATION section of the manual. Also see this: [hotkilns.com/calibrating-kiln](http://hotkilns.com/calibrating-kiln).

## ONE-TOUCH Thermocouple Offsets

Thermocouples can drift in their accuracy over time and this can cause inaccurate firings in the kiln. You may need to adjust the offset to trick the kiln into firing hotter or cooler. Read about THERMOCOUPLE OFFSET in the OPTIONS Section of the OPERATION OF L&L KILNS WITH A ONE-TOUCH™ (Deg F) in the OPERATION tab in your instruction manual. Also see this: [hotkilns.com/calibrating-kiln](http://hotkilns.com/calibrating-kiln).

# TROUBLESHOOTING AND REPAIR INSTRUCTIONS FOR L&L KILNS

## Vent System

1) Is your vent system on and pulling air? You can check this with a source of smoke in a cold kiln. (If you burn a small piece of paper near the holes on the bottom of the kiln with the vent on and THE KILN OFF you can see if the smoke is being drawn into the holes. You can also check this by feeling the output of the vent when the kiln is at high temperatures. The air coming out should be quite warm to the touch (about 110°F to 140°F). The Vent-Sure will aid in keeping your kiln uniform by drawing hot air from the top of the kiln towards the bottom. It counteracts the natural rising of the heat.

2) If you want to increase draw first close the Bypass valve on the Bypass Collection Box under the kiln. You can also increase the size of the vent holes in the bottom of the kiln. You can also try taking out the top peephole plug. See the L&L VENT-SURE DOWNDRAFT KILN VENT INSTRUCTIONS in the VENT section of your instruction manual or [hotkilns.com/vent-sure-instructions](http://hotkilns.com/vent-sure-instructions).

## KILN FIRES TOO HOT OR COLD

### Firing with Cones

Try using cone packs in all sections (top, center, bottom) of the kiln and keep records of what happens. See the TROUBLESHOOTING KILN FIRING WITH CONE PACKS in the LOG, CONES,TIPS, CERAMIC PROCESS tab or [hotkilns.com/troubleshooting-cones](http://hotkilns.com/troubleshooting-cones).

### Easy-Fire vs Vary-Fire (on DynaTrol)

Keep in mind that the Easy-Fire programs feature Orton software that adjusts the final temperature based on the speed of firing. This in effect adjusts the heat-work and hence the actual cone that the kiln fires to. This applies to Easy-Fire and cone-fire Vary-Fire programs.

### Be Careful with Hold Times

Be very careful with hold times. Even a fairly short hold time of 10 minutes can dramatically increase the amount of heat work and hence the cone that the kiln fires to. On the other hand you can use the hold time to increase the heat-work to compensate for underfired work. Just test this in small increments.

### Control Settings

1) The ceramic thermocouple protection tubes introduce a known error into the system. This is covered in the Operational Instructions but bears repeating here. The temperature that is measured by the tip of the thermocouple

is approximately 18 Deg F cooler than the actual kiln temperature. We have found through extensive testing that the best way to compensate for this is to put in a Thermocouple Offset of + 18 Deg on each thermocouple. The specific setting is **0018** on Easy-Fire kilns, along with a Cone Offset of **-20** (setting is **9020**) for EACH cone that you fire to on the Easy-Fire Programs (or **9030** on cones 022 to 017).

2) We have already programmed the control with this information so that you don't have to do it. However, we also provide step-by-step instructions on how to do it in BASIC OPERATION OF L&L KILNS WITH A DYNATROL 700 in the OPERATION tab of your manual (or [hotkilns.com/basic-operation-dynatrol](http://hotkilns.com/basic-operation-dynatrol)) and the OPERATION OF L&L KILNS WITH A ONE-TOUCH™ (Deg F) in the OPERATION tab of the School-Master instruction manual (or [hotkilns.com/basic-one-touch-f](http://hotkilns.com/basic-one-touch-f)) If you are using the VARY-FIRE programming on an Easy-Fire kiln then use a Thermocouple Offset of plus 70 (setting is **0070**).

### Thermocouple Drift

Thermocouples drift in their accuracy with time. You may have to make further adjustments in the Thermocouple Offset or Cone Offset settings over time. **You should change all thermocouples when you change elements because they age at approximately the same rate.**

## KILN STALLS

1) The kiln may refuse to increase in temperature, and the kiln will just run on and on. If it is re-started it may work fine for a while. The most likely cause is old or failing elements or relays. An issue in one circuit/section/zone can cause the whole kiln to stall as it waits for the problem section to "catch up". Check the temperatures in all zones to see if one zone is lagging behind and test elements and relays.

2) Thermocouples close to end of their useful life can cause some of these same problems.

3) Sometimes excessive ambient temperatures (over 125°F) around the control can cause stalling too.

4) Corroded connection points can also cause stalling.

5) Generally you will see the error message **Err1** when this happens.



# TROUBLESHOOTING AND REPAIR INSTRUCTIONS FOR L&L KILNS

## **KILN FIRES SLOWLY - BOTH SERIES**

### **Run a Simple Paper Test**

This will tell you if all kiln sections are firing. If they are not it could be a bad relay or maybe a bad internal switch on the control.

1. Place a little piece of paper in each element.
2. Then run a Fast Glaze (or turn the manual switches to Hi on a manual kiln) while you watch the papers.
3. They begin to smolder in about 2 minutes. After 3 or 4 minutes shut the kiln off.
4. This shows you if the elements are operating (or which ones are and which ones are not).

### **Bad or Wrong Voltage**

1) Check your voltage. Do this at the kiln at the Power Terminal Block with the control panel open or check it at your fused disconnect box. **CAUTION: This test should only be done by an experienced person familiar with electricity and its dangers.** You need to see what the voltage is when the kiln is firing. Low voltage will make the kiln fire considerably slower. For instance a kiln designed for 240 volts will have 25% less power when operated on 208 volts. Check voltage at your panel and where the kiln is connected. Check the voltage when the kiln is firing and when it is not firing. Sometimes the high amperage draw of the kiln will cause a voltage drop at the kiln. A voltage drop of 5 to 10 volts is not uncommon and is to be expected. If your voltage drop is more than that then you may have a problem with your electrical supply.

2) Make sure no other large electrical appliances such as a clothes dryer or electric oven are on when you are operating your kiln. This may cause a voltage drop which would slow the kiln down.

3) Voltage may vary in your area depending on season and time of day. Frequently there are "brown outs" during the summer months in some areas. This is when the electric utility reduces the voltage. Try firing at night after peak electrical use hours. You can use your Delay feature to do this easily. Find out from your local utility company when the end of the peak period of electrical use is. Some utilities offer preferential rates for using electricity at night because it is cheaper for them.

4) Check to see what the wire size of your circuit is. If it is very long (more than 50 feet) from your main circuit box then the wire size might need to be higher (e.g. #8 instead of #10 wire).

### **Element Aging**

1) Elements both age and increase in resistance when fired. When they increase in resistance the amount of power they develop decreases. See the section on "CHECKING ELEMENT RESISTANCE" at the end of this guide.

2) Replacing only one element per section or zone may cause an unbalance in firing. In Easy-Fire kilns the multi-zone control will compensate for much of this imbalance automatically, however, this will not be the case in School-Master kilns.

3) Use original L&L parts for satisfactory maintenance. (Elements, in particular, provided by other vendors may not work well in your L&L kiln. Some of our customers have found this out the hard way and thought it was an L&L problem. Only L&L has the design information to make our elements properly).

4) Empty the kiln. Then turn kiln on until elements are red. Open the door carefully and observe the elements to see if they all seem to be glowing about the same amount. **CAUTION:** The power does not turn off when you open the lid. Be careful not to put your hand inside the kiln while it is on. Dangerous electric shock could result. See the diagnostic program described in the earlier section called KILN FIRES UNEVENLY.

5) Elements expand and grow with age. If you fire low-fire clay and glazes and never get above cone 05 or so, your elements will last a long time, especially if you are only bisque firing. This is good, to a point. If you only low-fire, the problem you are most likely to encounter over many years is that the elements will expand as they age. The length and the coil diameter increase. Meanwhile the atmosphere in the kiln slowly eats away at the metal of the element. Although the total resistance usually increases as the elements age, sometimes it decreases, or reverses itself. This usually only happens when the elements are very old but have not yet failed completely. As the element expands, it binds up in the corners. This can make the individual coils push together and touch each other in the corners, making a short cut for the electricity, reducing the amount of element material the electricity must pass through, and therefore reducing the resistance in the whole element. This may make it hotter in the kiln, but if there is a lot of element material jammed in the corners there will not be enough material left in the coiled form to radiate the heat generated by the increased amperage and decreased resistance. Only the parts of the wire not touching the coils on either side of them will emit heat. More amperage through the electrical components in the control could cause damage if the situation continues or

# TROUBLESHOOTING AND REPAIR INSTRUCTIONS FOR L&L KILNS

the resistance drops far enough. In addition, the expanding diameter of an element can make it difficult to get it out of the holder. Usually this will not happen to those firing to higher temperatures because the maximum temperature of the kiln is quickly compromised by increases in the resistance, requiring the elements to be changed long before they can jam up in the corners. Also, high temperatures and glaze firings are more prone to eating through the element, causing it to fail, before the element can expand enough to cause the problems mentioned above. Visually inspect your elements for the above conditions and do a resistance check. If you see this it may be time to change elements.

## Power Relays

As mechanical switches, power relays will fail over time. In particular, the coil which actuates the switch closure increases in resistance to the point where it no longer has the power to close, especially as it gets hot. This means that a relay can work at low temps but fail at elevated ones, making it more difficult to diagnose.

## WIRES WILL GET HOT

Unlike many other appliances that use electricity (like motors) kilns are called a "resistive load." This means that there will be a continuous pull of steady electrical power for many hours. Even with properly sized wire this will generate SOME heat in the wires. This is one reason we recommend against using aluminum wire for a power feed. If you look carefully you will see that we have OVERSIZED our internal power wires far in excess of their rated capacity. In addition all our power wire is rated for very high temperatures. The larger the wires the less resistance in the wires and the cooler they will operate.

## Bad Wiring

1) Have an electrician check your wiring. We have seen aluminum wire cause intermittent problems with allowing enough voltage through. We do not recommend aluminum wiring although some electricians will swear by it. The problem with it is that aluminum oxide, which is formed from heat, is a resistor while copper oxide is not a resistor. With kilns you will often develop some heat in the electrical lines. If all connections are perfect and the wire is oversized you probably will not have a problem - but why take that chance? Make sure your wires are of the proper size and that all connections are good.

2) Check your circuit breaker for proper operation. These sometimes go bad over time.

3) If all the elements are firing and the kiln is still firing too

slow check the amperage draw of the kiln under a full load. CAUTION: This test should only be done by an experienced person familiar with electricity and its dangers. You need to see what the voltage is when the kiln is firing.

### Check amperage under load with an amp-probe.



3) To check to see if all zones are firing on an Easy-Fire kiln, press the number 8 on the control numeric pad. You will see one little light per zone under the numbers on the control display. If you see two dots on an e18S, e23S, or e28S then you are firing at full load. If you see three dots on an e18T, e23T, or e28T then you are firing at full load. See if the amperage drawn is the same as what the kiln is rated for. See the product literature and/or data nameplate on the kiln for the rated amperage draw. There is also a complete table of this information in the Installation Instructions part of this manual. For instance, a model e23T rated for 240 volts, Single Phase should draw 48.0 amps. If it is substantially less than the rated amperage draw and your voltage is within 5% of the rated voltage (for instance 230 volts for a 240 volt unit), then chances are the elements have changed in resistance. This will require element replacement.

**Pressing the number "8" will turn on 2 or 3 small LEDs that indicate whether the various zones are firing.**

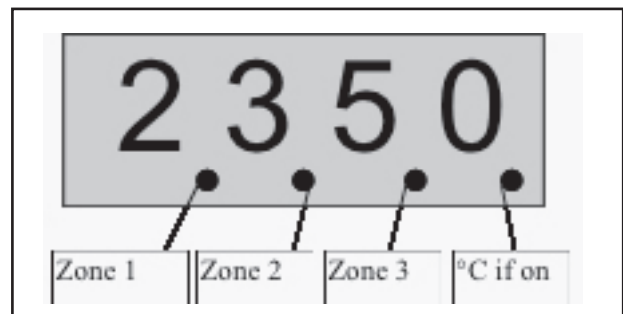

## Wiring in the Kiln

1) Unplug kiln.

# TROUBLESHOOTING AND REPAIR INSTRUCTIONS FOR L&L KILNS

- 2) Trace wiring for missing or bad connections.
- 3) Check wiring against wiring diagram.
- 4) Check for corroded connectors or connectors that have frayed wires. Replace if you see this.

## Element Connections

1) The holes where the elements go through the firebrick walls are too large. This could cause too much heat to escape from the kiln thereby overheating the element terminals. This can be remedied by lightly stuffing non-RCF ceramic fiber in the element holes. (See [hotkilns.com/non-rcf-fiber-blanket](http://hotkilns.com/non-rcf-fiber-blanket) for non-RCF fiber). You can stuff this in from the inside of the kiln using a sharp tool like a very small screw driver.

2) Check to see if the element ends are twisted properly. They should be twisted clockwise around the terminal screw. If the twist is too loose this could generate extra heat at the element ends. Check for corrosion on the terminal. If there is corrosion sometimes you can remove it with a wire brush.

3) The element connection hardware may not be tight enough. A loose connection can generate heat and cause oxidation of the hardware which in turn will cause a worse electrical connection (because of resistance) and more heat. Replace with new terminal hardware. See [hotkilns.com/parts](http://hotkilns.com/parts) and filter for **Model Series** and **Elements (Terminals)**

## Heat Leakage & Vents

- 1) Make sure peephole plugs are in.
- 2) Make sure hole for vent is proper. Check Vent-Sure instructions for proper hole sizes.
- 3) If you are using a different brand of vent make sure it is the appropriate size for your kiln. Check with the vent manufacturer and tell them how many cubic feet are in your kiln.
- 4) If your lid or bottom is cracked check to see if it seems to be leaking much heat at high temperatures. Patch or replace if extreme. (SOME IS OK).

## Adding More Insulation

- 1) In L&L's top loading kilns an additional bottom may be placed under the original bottom. This will improve the insulation in the kiln, thereby slowing heat loss and speeding the firing time. You can also put a 2" layer of calcium silicate on top of the stand beneath the bottom of the kiln.
- 2) Also try raising the height of the kiln from the floor or putting a reflective stainless steel or aluminum sheet under

the kiln. All these things keep the floor from absorbing the radiant energy from the kiln and will improve heat up times (as well as bottom of the kiln uniformity).

3) Put a 1" layer of non-RCF ceramic fiber on the lid. This is completely non-hazardous which is important in this application because you will be releasing fibers into the air when you move it while loading. While this is a somewhat extreme measure we have found that a disproportionate amount of the heat loss from a kiln is through the top. Non-RCF ceramic fiber is soluble in the body and is considered totally safe.

4) Whatever you do be sure NOT to put the kiln directly on the floor. If the floor is cement or other hard non-flammable material it will absorb the heat from the kiln. If the floor is wood or other flammable material you will create a very DANGEROUS situation which could cause a serious fire.

## KILN FIRES SLOWLY - EASY-FIRE

### Single vs Three Zone Control

1) Three zone control will slow a kiln down. It helps even out the temperatures in a kiln by shutting off one or more zones while firing. In addition zone control introduces other issues like LAG that sometimes complicate a firing. The first thing to try if you are getting a slow firing is to switch the kiln to single zone operation. That may get you back into operation quickly. Then, if that makes the problem go away you can fine tune the specific issue within the zone system that is causing the problem.

2) Normally models e23S and e28S are programmed to have two zones and models e23T and e28T are programmed to have three zone control. You can easily change this to be single zone operation.

3) Press **OTHER, 4, 4, 3**

4) The display says **notC** This stands for "number of thermocouples".

5) To run the kiln using only one thermocouple press **ENTER** at the **notC** prompt. You will then see **0003** or **0002** (depending on whether it is currently programmed for three zones or two zones). Then press **1**, then **ENTER**. The display will then say **StOP**. All the zones of the kiln will turn on and off simultaneously when you program the DynaTrol to use only one thermocouple.

# TROUBLESHOOTING AND REPAIR INSTRUCTIONS FOR L&L KILNS

## ShtO (SHUT-OFF) SETTING

- 1) This option is used to shut off the automatic feature in the DynaTrol that holds the hottest part of the kiln at each segment's set point until the average of the three (or two) thermocouples reaches that set point. This can have a dramatic effect on speed of firing and is worth trying to see if it helps you if you are having a problem.
- 2) When you press **OTHER, 4, 4, 3**.
- 3) Press **OTHER** until **ShtO** is displayed.
- 4) Pressing **ENTER** here allows you to toggle, using any number key, between **On** and **OFF**.
- 5) **On** means that as soon as the hottest zone gets to the segment's set point the entire kiln switches to either the "hold time" or the next segment. This will result in a quicker firing.
- 6) **OFF** means that the DynaTrol will not let the hottest zone's temperature rise until the average temperature of the three zones reaches that segment's set point. Then the kiln can begin the "hold time" or the next segment. This will result in more even firing.
- 7) When you have the setting you want shown in the display (On or **OFF**) press **ENTER**. **CPL** will display for a few seconds and then **Idle**, **tC2** and current temperature.

## PId SETTING

- 1) This setting generally should be left at its factory default because it is hard to predict the changes that it will create in your firing. However, a full explanation is given for more advanced users who want to experiment with this.
- 2) This setting comes pre-programmed at the factory for 65%. Basically this setting determines how much help the middle zone of the kiln gives the bottom zone of the kiln when the bottom zone is lagging behind during heating. This comes into play when the bottom zone is on 100% of the time. With this feature, the middle zone of the kiln will come on the programmed percent (**PId**) of the time that the TOP zone comes on, if the bottom zone is on all the time. Tests showed that if the bottom was on 100% of the time, the top zone was generally on 90% of the time, but the middle zone was on only about 40% of the time. By programming a higher percent you can greatly speed up your firings. (you will have to experiment, try the factory setting 65% then try maybe 100% and compare your results). Basically the higher the **PId** setting the faster the firing at the potential price of unevenness.
- 3) As your elements age firing by firing, this setting will activate earlier and earlier in the firing because the bottom

will be working at 100% earlier and earlier. This will allow the artificial inflation of the center's temperature sooner and sooner. Because this center is heating based on mathematics now and not it's own thermocouple's reading, it will have a longer and longer period of time to get hotter than the top and the bottom. In some cases this can lead to gross unevenness. You may find yourself dialing down the **PId** to something like 50% or 60%. Remember that if it is set around 40% (it's normal operating percentage) or below, the thermocouple's reading then will be the control for that section, not the mathematics of the **PId** feature.

- 4) When display flashes **Idle**, **tC2** press **OTHER** see **rSEt**. Press **4, 4, 3**. See **notC**
- 5) Keep pressing **OTHER** to cycle through the menu options until you get to **PId**.
- 6) Press **ENTER**. See **Pct**, **00&5** cycling.
- 7) Press any number from **0** to **150**, see the number you have entered preceded by a zero like **0120** if you entered **120**. Press **ENTER**, see **CPL** or **StOP** for a few seconds, then **IDLE**, etc.
- 8) Pressing **ENTER** here allows you set another percent setting that can help a slow, heavily loaded kiln fire faster.

## Change elements to graded elements.

This is an extreme solution for Easy-fire kilns but can be effective. Contact factory.

## KILN HEATS TOO FAST

### Relays

- 1) A stuck relay, meaning that the power relay is stuck closed, delivering constant power to the elements, can cause the kiln to heat uncontrolled. If the kiln is still heating even when no program is firing or even the toggle switch is off, then you have a stuck relay. Whichever section is still heating, that is the relay that needs replacing.

### Voltage

- 1) Check your voltage. Some people may have high voltage like 245 volts where you should nominally have 240 volts.
- 2) Make sure you don't have a 208 volt kiln hooked up to a 240 volt circuit. This is dangerous because the kiln will draw more amps than it is rated for which will overload the power wires and other components and could cause a fire.

### Elements

- 1) Check element ohms and compare with factory values. (See CHECKING ELEMENT OHMS later in this section).



# TROUBLESHOOTING AND REPAIR INSTRUCTIONS FOR L&L KILNS

2.) Make sure the elements are wired properly. Check the wiring diagram.

## EASY-FIRE ERROR MESSAGES

See this for a complete description on the web: [hotkilns.com/error-codes](http://hotkilns.com/error-codes). You can also see more information in the instruction manual in the CONTROL section: Appendix E in DYNATROL 700 INSTRUCTIONS FOR L&L KILNS.

Error codes can appear at any time during the firing. They always refer to a problem that, if allowed to continue, could end with unknown or even disastrous results. **Errd**, **Err1**, **ErrP** and the **FAIL** message make the most frequent appearances. **Errd** means there is a temperature difference of more than 50 degrees between the zones. **Err1** indicates that the kiln is climbing too slowly in an Easy-Fire program. **ErrP** indicates that there was either a very quick power outage (**ErrP** will flash along with the temperature and the kiln will still be heating), or there was a longer power outage (**PF** will be the only thing in the display and the kiln will not be heating). **FAIL** refers to a specific thermocouple failure. It will appear after displaying a 'tC' (thermocouple) number 1, 2 or 3.

### Errd

1) If the kiln was just re-assembled and **Errd** is the error code, then double-check that the element connection wires go to their proper power relays and that the thermocouple wires are connected to the proper zones.

2) If you are sure the kiln is set up properly, nothing is out of place and none of the thermocouples are partially out of the kiln, then one of the following situations may apply:

3) You were firing with the lid open and you got **Errd** either while the lid was open or right after you closed it. For drying with the lid open, only about two inches is needed to adequately vent off water vapor. This is plenty if all the peep holes are open. The DynaTrol will attempt to compensate for the heat loss, and it usually can. The trouble may happen when you close the lid. The elements in the top of the kiln are already much hotter than the ones nearer the bottom due to their need to compensate for the heat loss from the top. When you close the lid it can take as long as eight seconds for the DynaTrol to respond to the rise in temperature in the top of the kiln, and shut off those elements. This can quickly cause an uneven temperature in the kiln, which will usually result in **Errd** (possibly an **Err2** in a smaller kiln -**Err2** is when the entire kiln temperature is more than 50°F over the hold time's temperature for longer than 18 seconds).

4) There was a lot of air being exhausted from your kiln when **Errd** appeared. If a vent system pulls too much air from just one point in the kiln, say, to down-ramp the load very quickly to a lower hold time for crystal formation, an uneven temperature can result. The firing will go slowly as it will be difficult to compensate for the heat loss; eventually, however, the **Errd** (or **Err1**) can appear.

5) Something is too close to, or is touching, **TC#** in the kiln. Allow almost an inch between everything for thermal expansion. Fix and re-fire the kiln.

6) A thermocouple wire has melted against the kiln case. The wire must be replaced.

7) A thermocouple is about to fail. Perform a physical inspection if possible, or just re-start the kiln and monitor it carefully.

8) Element(s) just burned out. Perform an ohms test for more information.

9) A relay has just failed. Perform a voltage test.

10) There is a bad connection point somewhere. This will become more of a possibility as the kiln ages. Examine all points carefully for melting, corrosion, and discoloration.

### Err1

1) If **Err1** is the error code on the screen when you check on the firing, then for some reason the kiln could not generate enough heat to counter the heat loss. If the kiln can get no hotter (even though all the elements appear to be on and the program is not holding), then **Err1** is what you will see. If one of the elements or one of the circuits in the control fails while the kiln is at a high enough temperature then it will probably display an **ErrB** code (which means temperature is falling when it should be rising) **Err1** or **ErrB** can mean either you need new elements or a new component in one of the circuits. An ohms test and a voltage test can tell you which it is. If you recently changed locations, power supplies, elements, or did any repairs, then closely examine what changed between your last successful firing and this one. There may be some other issue besides bad elements or a bad component.

2) A new location can mean a 208 volt power supply rather than a 240 volt supply (about 25% less power).

3) In re-wiring the power supply you may not have used thick enough copper wire (line, conduit and connection points will be very hot).

4) The elements are the wrong resistance. Check new elements with your multimeter just to be safe. Mistakes can happen.



# TROUBLESHOOTING AND REPAIR INSTRUCTIONS FOR L&L KILNS

5) If you rewire anything improperly or incorrectly the potential for anything from a blown breaker to just no power at all is possible. (Using wire with a temperature rating of less than 150°C for the power wiring can seriously limit the life of the circuitry and can be dangerous as well, especially when the wires are close to the kiln.) Use a wire diagram and trace every wire to check yourself. You can buy high temperature wire from L&L (see the Parts List).

## Err2

During a hold segment the temperature rises to greater than 50 degrees above the hold temperature which was set. The temperature must stay 50 degrees above this set temperature for 18 seconds before the error is displayed.

## Err3

During a hold segment the temperature is more than 50 degrees below the hold temperature which was set. The temperature must stay 50 degrees below this set temperature for 18 seconds before the error is displayed.

## Err4

The temperature is more than 50 degrees above the previous hold temperature during a ramp segment where the temperature is programmed to decrease. The temperature must stay 50 degrees above this set temperature for 18 seconds before the error is displayed.

## Err5

The temperature is more than 50 degrees below the local setpoint temperature during a ramp segment where the temperature is programmed to decrease. The temperature must stay 50 degrees below this set temperature for 18 seconds before the error is displayed.

## Err6

A Negative temperature is displayed. This generally indicates the thermocouple is connected incorrectly. To correct this situation, ensure the red and yellow wires are connected correctly to the controller and at all junctions. You can identify the red lead on an unmarked thermocouple with a magnet because a magnet will be attracted to the red lead.

## Err7

The temperature is more than 50 degrees above the local setpoint temperature during a ramp segment where the temperature is programmed to increase. The temperature must stay 50 degrees above this set temperature for 18 seconds before the error is displayed.

## Err8

When using the Easy Fire Mode, the temperature is decreasing during the last ramp segment. This could indicate that the lid was up or the peepholes open or some other physical thing is causing the kiln to decrease in temperature.

## ErrP + PF

Continuous **PF** in display. Indicates a long term power outage. The kiln has been shut down. Press **1** to clear the display.

**ErrP** and the current temperature are alternately flashing. To clear the display, press the **1** key. If a firing was in progress, the kiln will continue to fire even though this message is flashing. This error can also happen as a result of RF (radio frequency) noise that resets the microprocessor. If this is suspected, the control panel should be returned to L&L for testing and possible modification. Also see [hotkilns.com/noise](http://hotkilns.com/noise)

## Err-

The **Err** with a dash indicates there was a power loss to the controller while writing a program to the non-volatile memory chip. Recheck the selected program, and reprogram if necessary.

## FAIL

1) If, upon inspection, the error code **FAIL** turns out to be a burned out thermocouple then replace it. You typically will not need to replace the mullite protection tube - just the internal thermocouple "element" (see [hotkilns.com/thermocouple-k-standard](http://hotkilns.com/thermocouple-k-standard)). You should not mix unsheathed thermocouples with sheathed ones. (because their response rates are slightly different). A spare on hand is a good idea as well.

2) If the TCs are not bad (you just replaced them and they worked fine for at least one complete firing) but the **FAIL** message still appears, it may be that the TC wire is bad (melted or broken at a point) or the electronics have partially failed.

A) Turn OFF the power at the Disconnect Switch or Circuit Breaker and/or unplug the kiln.

B) Open the cover of the control.

C) Remove the Thermocouple wires from the DynaTrol and the Thermocouple Terminal Strip. Take out of the Control Box and set aside.

D) Make tiny "U" shaped jumper wires from paperclips and jumper between each of the + and - connections on the

# TROUBLESHOOTING AND REPAIR INSTRUCTIONS FOR L&L KILNS

DynaTrol board.

E) You are simply completing each TC circuit without using the TC wire or the TC. Do not let the 'U's touch anything other than the TC connection points. Note: the fact that a paperclip is not the proper type of metal to use in a Type K TC circuit is not an issue for a test like this.

F) Close up the Control Box and turn the unit on. If it still says **FAIL** then the electronic board has failed. If it reads room temperature then the TC wire or the TC has failed.

G) If it reads room temperature with these jumpers in, and you are not sure if it is the TC or the TC wire, just re-attach TC2's wire to TC3 and re-attach TC3's wire to TC2. If the **FAIL** message is still on **TC2** then it is the wire, not the TC. If it says that the **FAIL** is now at **TC3**, then you know it is the TC, not the wire (there are many other ways to determine this as well).

## Turning Error Codes On or Off

1) When you receive your DynaTrol the error codes are turned on. In most cases, you will want the error codes on. They can be turned off if you are doing special firings, such as jewelry or glass firing where the kiln is opened while hot. Turning the error codes off turns off the dynamic zone control feature that keeps the temperature in the kiln even top to bottom. It eliminates nuisance shut downs but side steps built in fail-safe measures.

2) The only Error codes that this can not turn off are **ErrB**, **FAIL**, and **ErrP** in both the "Easy Fire" and "Vary Fire" modes. In addition **Err1** and **ErrB** are not turned off in the last segment of an "Easy Fire" program. This is because the built in calculations would make no sense if the kiln were firing too slowly.

3) To turn Error Codes off do the following:

4) Press the **OTHER** button several times until you see **ErCd**.

5) Press **ENTER**

6) Display will say **On** (which indicates that the error codes are turned on) or **OFF** (which indicates that the Error Codes are Off). You can toggle back and forth between on and off by pressing the **1** key.

7) Hit **ENTER** when you see **On** or **OFF** and you want to keep that setting

8) **CPL** will display for a few seconds. **IdLE**, **tC2**, and the current temperature then cycle in the display.

## Can you restart the kiln after it stops because of Error Codes?

You can try to restart the kiln after getting an error code. Some messages, like flashing **ErrP** and **FAIL**, will not necessarily turn off the kiln. Depending on the problem though, re-starting it may or may not let it finish the firing, or even start up again. An **Errd** will usually not re-start easily because the temperature top to bottom is drastically different. An **Err1** at the end of the firing will re-start but will probably re-occur in about 22 minutes. A **FAIL** message will not go away even if the problem is fixed during the firing. The kiln can still be firing with the **FAIL** message flashing along with the number of the TC that failed. Stopping and then re-starting the kiln after fixing the problem with the TC circuit is the only way to erase the **FAIL** message. **ErrP** flashing with the temperature means that the kiln is still firing, after just a short power outage or interference. Just press any number to clear the **ErrP**. An **ErrP** which is not flashing must be re-started.

## Worst Case Scenario for Restarting After an Error Code

Keep in mind that you run the risk of over-firing if you re-start while the kiln is very close to the final temperature. A pyrometric cone melts with the proper combination of time and temperature. Add more time and you don't need as high a temperature, go to a higher temperature and you don't need as much time. When an error code shuts down the kiln near your final temperature (within about 50 degrees) and you do not know exactly how long it has been cooling, or what temperature it reached before the error code appeared, you run the risk of having too much unaccounted for time in your time-temperature equation. The DynaTrol calculates this equation automatically after determining how many degrees per hour the kiln is climbing (time) and to what temperature it is climbing to (temperature). However, it cannot do this accurately after a high temperature re-start.

If you have cones in the kiln that you can see through the peepholes, then use these after you re-start and turn off the kiln manually when the target cone bends over.

If you do not have cones visible then you can gamble and estimate a final temperature based on how many degrees per hour the kiln has risen, including the time it was off.

For example, you come in and the control says **tC2**, **2200** (degrees F) and everything seems fine in your slow glaze to cone 6 firing. But twenty-five minutes later you come back and see **Err1**.

The first thing you want to do is press 1 to clear the error

# TROUBLESHOOTING AND REPAIR INSTRUCTIONS FOR L&L KILNS

code. Look for tC2's temperature and write it down. It might be 2175. You have no cones in the kiln but you really need these pieces fired.

Wait a few seconds until you see "IDLE, tC2, 2175". Press **START** to re-start the program and note the time on your watch. Note the 25 minutes the kiln was "holding" from the last time you saw it at 2200°F until this time, where it says 2175. It must have continued to climb somewhat, but because the Err1 will appear after 22.5 minutes of holding when the kiln is programmed to be climbing, it probably never got over 2210°F. So the kiln has held at an average of about 2195°F for about 25 minutes, instead of continuing on to 2232°F (cone 6) to finish the firing.

The relationship between time and temperature allows you to estimate how much hold time to add to get the same amount of heat work as the kiln would have achieved by climbing to 2232°F. Assuming a 108°F per hour temperature rise, a good rule of thumb is to add about a 20 minute hold to the maximum temperature; this will allow you to lower the final temperature by about 20°F. An hour hold time would mean a final temperature of about 40°F lower. A two hour hold time would be about 60°F lower.

In this example, the kiln has already held at about 35 degrees lower than the final temperature for 25 minutes. It would need another 25 minutes of holding to give the ware the same amount of heat work that 2232°F (cone 6) would have.

In reality, however, an Err1 that close to the end of a firing probably means you need new elements. So re-starting the kiln will probably not enable it to climb much higher in temperature. Keeping track of the time, let it run, and when it shows Err1 again just keep re-starting it until the firing finishes. Meanwhile call and order new elements.

Be very careful if you try this method. On loads that are very important always use cones you can see through the peepholes in case of a failure of some kind. If you have to use this method without the cones, remember that almost all your calculations are based on estimates and the results could be disastrous to your ware and/or the kiln if you are not accurate enough. The further away the temperature that the kiln is holding at is from the cone that the firing was trying to get to, the less accurate an estimated amount of time will be to achieve the amount of heat work necessary. If you can wait and re-fire from room temperature, you should. If you depend in any way on your kiln you should keep spare parts around for it. You could replace the elements easily yourself after the kiln cools and then re-load it and re-fire it to the proper cone without losing much time at

all. Or consider that most glazes have an entire cone's temperature range that they can mature within. Weigh your options and decide.

In general though, Error Codes mostly appear after the kiln has been disassembled and set back up improperly, has had its power supply altered (like moving to a new studio with different voltage), or has had an element, a relay, or a thermocouple burn out.

## ONE-TOUCH ERROR MESSAGES

Error codes can appear at any time during the firing. They always refer to a problem that, if allowed to continue, could end with unknown or even disastrous results. Errd, Err1, ErrP and the FAIL message make the most frequent appearances.

### Errd

Error d indicates that the kiln temperature is 100°F above the traveling set-point, which is the current desired temperature in the kiln. The traveling set-point will increase or decrease according to the programmed rate.

- 1) Something is too close to, or is touching the thermocouple. Allow almost an inch between everything for thermal expansion. Fix and re-fire the kiln.
- 2) The Thermocouple Lead Wire has melted against the kiln case. The wire must be replaced.
- 3) The thermocouple is about to fail. Perform a physical inspection, or just re-start the kiln and monitor it carefully.
- 4) Element(s) just burned out. Perform an ohms test for more information.
- 5) The relay has just failed.
- 6) There is a bad connection point somewhere. This will become more of a possibility as the kiln ages. Examine all points carefully for melting, corrosion, and/or discoloration.

### Err1

Error 1 indicates the temperature in the kiln is rising during an up ramp slower than 15°F/hr. If this rate continues for 8 minutes the firing will be stopped. Err1 may be an indication that the elements are worn or that a relay has stopped working.

- 1) If Err1 is the error code on the screen when you check on the firing, then for some reason the kiln could not generate enough heat to counter the heat loss. If the kiln can get no hotter (even though all the elements appear to be on and the program is not holding), then Err1 is

# TROUBLESHOOTING AND REPAIR INSTRUCTIONS FOR L&L KILNS

what you will see. **Err1** can mean either you need new elements or a new relay. An ohms test and a voltage test can tell you which it is. If you recently changed locations, power supplies, elements, or did any repairs, then closely examine what changed between your last successful firing and this one. There may be some other issue besides bad elements or a bad component.

2) A new location can mean a 208 volt power supply rather than a 240 volt supply (about 25% less power).

3) In re-wiring the power supply you may not have used thick enough copper wire (line, conduit and connection points will be very hot).

4) The elements are the wrong resistance. Check new elements with your multimeter just to be safe. Mistakes can happen.

5) If you rewire anything improperly or incorrectly the potential for anything from a blown breaker to just no power at all is possible. (Using wire with a temperature rating of less than 150°C for the power wiring can seriously limit the life of the circuitry and can be dangerous as well, especially when the wires are close to the kiln. Use a wire diagram and trace every wire to check yourself). You can buy high temperature wire from L&L (see the Parts List).

## ErrP

**ErrP** is displayed whenever there is a power interruption that is long enough to stop the firing. If the power interruption is brief the kiln will continue to fire when power is restored; in this case there will no indication of a power failure. To clear the error, press any key.

This error can also happen as a result of RF (radio frequency) noise that resets the microprocessor. If this is suspected, the control panel should be returned to L&L for testing and possible modification. Also see [hotkilns.com/noise](http://hotkilns.com/noise)

## ErrF

**ErrF** indicates the temperature in the kiln is decreasing during a down ramp less than 15°F/hr. If this rate continues for 8 minutes the firing will be stopped. **ErrF** may be an indication that a relay has stuck in the on position.

## tC-

**tC-** indicates that the red and yellow thermocouple wires are reversed. Make sure they are right all the way through the circuit.

## FAIL

See the section in these Troubleshooting Instructions called DISPLAY READS **FAIL** and **tC**.

## Can you restart the kiln after it stops because of Error Codes?

You can try to restart the kiln after getting an error code. Some messages, like flashing **ErrP** and **FAIL**, will not necessarily turn off the kiln. Depending on the problem though, re-starting it may or may not let it finish the firing, or even start up again. An **Err1** at the end of the firing will re-start but will probably re-occur in about 22 minutes.

## Worst Case Scenario for Restarting After an Error Code

Keep in mind that you run the risk of over-firing if you re-start while the kiln is very close to the final temperature. A pyrometric cone melts with the proper combination of time and temperature. Add more time and you don't need as high a temperature, go to a higher temperature and you don't need as much time. When an error code shuts down the kiln near your final temperature (within about 50 degrees) and you do not know exactly how long it has been cooling, or what temperature it reached before the error code appeared, you run the risk of having too much unaccounted for time in your time-temperature equation.

If you have cones in the kiln that you can see through the peepholes, then use these after you re-start and turn off the kiln manually when the target cone bends over.

If you do not have cones visible then you can gamble and estimate a final temperature based on how many degrees per hour the kiln has risen, including the time it was off.

For example, you come in and the control says **2200** (degrees F) and everything seems fine in your slow glaze to cone 6 firing. But twenty-five minutes later you come back and see **Err1**.

The first thing you want to do is press **1** to clear the error code. Look for the temperature and write it down. It might be **2175**. You have no cones in the kiln but you really need these pieces fired.

Wait a few seconds until you see "**Idle, 2175**". Press **START** to re-start the program and note the time on your watch. Note the 25 minutes the kiln was "holding" from the last time you saw it at 2200°F until this time, where it says **2175**. It must have continued to climb somewhat, but because the **Err1** will appear after 22.5 minutes of holding when the kiln is programmed to be climbing, it probably never got over 2210°F. So the kiln has held at an



# TROUBLESHOOTING AND REPAIR INSTRUCTIONS FOR L&L KILNS

average of about 2195°F for about 25 minutes, instead of continuing on to 2232°F (cone 6) to finish the firing.

The relationship between time and temperature allows you to estimate how much hold time to add to get the same amount of heat work as the kiln would have achieved by climbing to 2232°F. Assuming a 108°F per hour temperature rise, a good rule of thumb is to add about a 20 minute hold to the maximum temperature; this will allow you to lower the final temperature by about 20°F. An hour hold time would mean a final temperature of about 40°F lower. A two hour hold time would be about 60°F lower.

In this example, the kiln has already held at about 35 degrees lower than the final temperature for 25 minutes. It would need another 25 minutes of holding to give the ware the same amount of heat work that 2232°F (cone 6) would have.

In reality, however, an **Err1** that close to the end of a firing probably means you need new elements. So re-starting the kiln will probably not enable it to climb much higher in temperature. Keeping track of the time, let it run, and when it shows **Err1** again just keep re-starting it until the firing finishes. Meanwhile call and order new elements.

Be very careful if you try this method. On loads that are very important always use cones you can see through the peepholes in case of a failure of some kind. If you have to use this method without the cones, remember that almost all your calculations are based on estimates and the results could be disastrous to your ware and/or the kiln if you are not accurate enough. The further away the temperature that the kiln is holding at is from the cone that the firing was trying to get to, the less accurate an estimated amount of time will be to achieve the amount of heat work necessary. If you can wait and re-fire from room temperature, you should. If you depend in any way on your kiln you should keep spare parts around for it. You could replace the elements easily yourself after the kiln cools and then re-load it and re-fire it to the proper cone without losing much time at all. Or consider that most glazes have an entire cone's temperature range that they can mature within. Weigh your options and decide.

In general though, Error Codes mostly appear after the kiln has been disassembled and set back up improperly, has had its power supply altered (like moving to a new studio with different voltage), or has had an element or a thermocouple burn out.

## SERVICE FOR YOUR KILN

---

### WHERE TO GET SERVICE

See the SERVICE Section of your Instruction manual or see [hotkilns.com/technical-support](http://hotkilns.com/technical-support)

### WHERE TO BUY PARTS

You can order parts for your L&L Kiln through L&L or your local distributor. See the Parts List that pertains to your particular kiln model. Our on-line parts list is easy to navigate. See [hotkilns.com/parts](http://hotkilns.com/parts). Standard Parts are typically shipped the day after an order is placed. Rush service is available.

### REPLACEMENT ELEMENTS

Replacement Elements made by L&L Kiln Mfg., Inc. are designed for each individual model for long life and superior performance. Good element design is a complex balance of watt density, design voltage, stretch ratio, wire gauge, element length and material. It takes many hours and years of experience to design a good element for each model. Do not expect an outside supplier with no interest in your kiln performance or long experience with L&L kilns to spend the necessary time to do this right. In the end you will not save

**NOTE:** Many of these procedures have accompanying instructional videos. Look out for the video links in each section or go to [hotkilns.com/videos](http://hotkilns.com/videos) for more.

## REMOVING PANEL FOR SERVICE

---

- 1) It is easy to access the inside of the control panel for troubleshooting. In addition it is easy to remove this panel and send it back to the factory for inspection and/or repair.
- 2) Disconnect power and unplug the kiln.
- 3) Follow the instructions in ASSEMBLY INSTRUCTIONS FOR in the ASSEMBLY tab of your instruction manual or see [hotkilns.com/assemble-easy-school](http://hotkilns.com/assemble-easy-school) in order to remove the Control Box for Easy-Fire and School-Master kilns.
- 4) Pack the control panel with cushioning material such as bubble wrap, balled-up newspaper or foam in a cardboard box and follow instructions from the factory or your local distributor about where to send it. **DO NOT SEND A CONTROL PANEL WITHOUT CALLING FIRST.**



# TROUBLESHOOTING AND REPAIR INSTRUCTIONS FOR L&L KILNS

**CAUTION:** The controller contains electronic components which are sensitive to static electricity. Before handling the controller dissipate any static charge you may have by touching metal or a screw on the controller panel, the electrical box, the kiln lid, or some other grounded object.

## REPLACING DYNATROL

See this video: [hotkilns.com/replace-dynatrol](http://hotkilns.com/replace-dynatrol)

- 1) Unplug kiln or turn off the kiln at the fused disconnect switch.
- 2) Remove the four #6 screws that hold the DynaTrol in place from the front face of the control panel.
- 3) Open up the control box and hinge down for access (as shown on page 2)
- 4) Pull off the spade connectors from all the connection points on the back of the control. Loosen the screws that hold down the thermocouple wires and pull out the wires from under the screw heads. It is OK to remove the screws if this is easier for you. First note where all the wires go. These are all clearly marked with color coding on the Wiring Diagram.
- 5) Pull old control out. Put new control in and screw in place with the #6 mounting screws. Replace wires on proper connectors.
- 6) Be careful to get the Red or Yellow of the thermocouple wires to match the colors painted on the DynaTrol board.

**Picture showing thermocouple wires installed on DynaTrol. There is no need to wrap the thermocouple wire around the screw head- although it is OK to do so. However, do make sure the wire is tight and secure UNDER the screw head.**

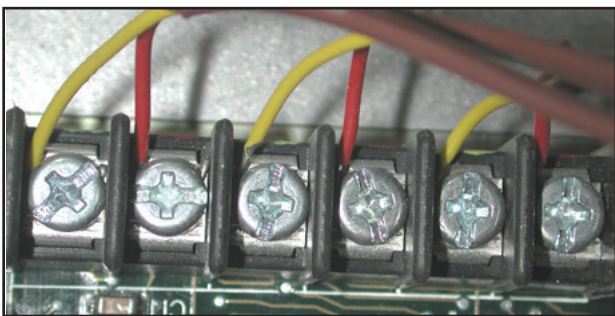

- 7) Double check that the proper color coded wire goes to the proper terminal.

**Orange = OUT 1**

**Blue = OUT 2**

**Purple = OUT 3 (not on e18S, e23S, and e28S)**

**Gray = AC1**

**Green = CT**

**Brown = AC2**

**TC1 = TC1**

**TC2 = TC2**

**TC3 = TC3 (not on e18S, e23S, and e28S)**

## REPLACING ONE-TOUCH™

See this video: [hotkilns.com/replace-dynatrol](http://hotkilns.com/replace-dynatrol) (Note the process of changing a DynaTrol is very similar)

- 1) Unplug kiln or turn off the kiln at the fused disconnect switch.
- 2) Remove the four #6 screws that hold the One-Touch™ in place from the front face of the control panel.
- 3) Open up the control box and hinge down for access (as shown on page 3)
- 4) Pull off the spade connectors from all the connection points on the back of the control. Loosen the screws that hold down the thermocouple wires and pull out the wires from under the screw heads. It is OK to remove the screws if this is easier for you. First note where all the wires go. These are all clearly marked with color coding on the Wiring Diagram.
- 5) Pull old control out. Put new control in and screw in place with the #6 mounting screws. Replace wires on proper connectors.
- 6) Be careful to get the Red or Yellow of the thermocouple wires to match the colors painted on the control board.

# TROUBLESHOOTING AND REPAIR INSTRUCTIONS FOR L&L KILNS

Picture showing thermocouple wires installed on Control. One screw is removed to show how the TC wire should be prepared with a "U" shape.

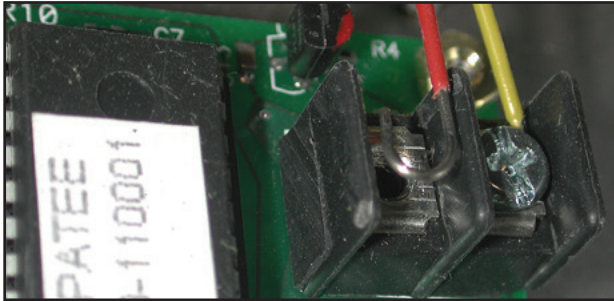

7) Double check that the proper color coded wire goes to the proper terminal.

**Orange = J5**

**Gray = J2**

**Green/Yellow= J4**

**Brown = J3**

## REPLACING TRANSFORMER

See this video: [hotkilns.com/change-transformer](http://hotkilns.com/change-transformer)

- 1) Unplug kiln or turn off the kiln at the fused disconnect switch.
- 2) Open up the control box and hinge down for access (as shown on page 2).
- 3) Using needle nose pliers pull off the wires from the transformer. THIS CAN BE TRICKY. It can take a good bit of force sometimes to remove these little spade connectors. You will probably not be able to do it with just your hands. Also the spade connectors on the transformer are not very strong. Take your time. Of course, if you are replacing a bad transformer it doesn't matter if you damage it.

**Showswires being pulled off the control transformer.**

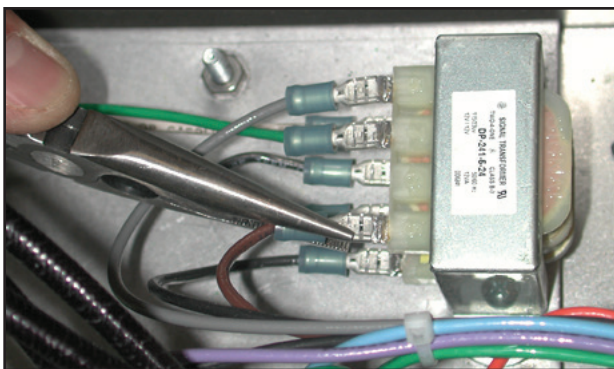

- 4) Unscrew the two #8 screws that hold the control

transformer onto the Contactor Panel and remove the transformer.

- 5) Before installing the new transformer put the small jumper wire onto terminals #2 and #3 on the bottom row of terminals. Note the little numbers by the contacts.

## REPLACING POWER RELAYS

See this video: [hotkilns.com/change-relay](http://hotkilns.com/change-relay)

- 1) Unplug kiln or turn off the kiln at the fused disconnect switch.
- 2) Open up the control box and hinge down for access (as shown on page 2).
- 3) Pull off the wires to the relay(s) that you are replacing. Everything is color coded and marked so you can refer to the wiring diagram when replacing if you forget where the wires go. The wire lengths also don't give you much choice and will help keep you from making a mistake.
- 4) Unscrew the #8 screws that hold the relays in place. Remove old relay and replace with new one.
- 5) Visually inspect the wire connectors. Do they look corroded or "cooked"? Are the wires frayed? Any corrosion on the wire itself? If any of this is questionable you may need to replace the appropriate wire harness.
- 6) Reconnect all wires. Visually inspect to make sure the spade connectors are down as far as they can go and feel to see that they are tight (a gentle tug should not remove one). If they are loose for some reason remove the wire and slightly squeeze the spade connector with pliers to tighten it.

**IMPORTANT: The slip on wire connectors can not be loose or corroded.** If there is a bad connection then heat will be generated and the component that they slip onto (relay, terminal strip, etc) may overheat and fail. If you squeeze the slip on terminal to make it tighter - be sure to squeeze it evenly so that one side is not tight and the other loose. If there are any doubts about the integrity of the wire or the connector replace the whole wire or harness.

## REPLACING FUSE HOLDER

See this video: [hotkilns.com/change-fuse-holder](http://hotkilns.com/change-fuse-holder)

- 1) Unplug kiln or turn off the kiln at the fused disconnect switch.
- 2) Open up the control box and hinge down for access (as shown on page 2).
- 3) Remove the wire connectors from the end of the fuse

# TROUBLESHOOTING AND REPAIR INSTRUCTIONS FOR L&L KILNS

holder on the inside of the panel.

- 4) Unscrew the nut that holds the fuse holder in place.
- 5) Remove and replace with a new fuse holder. Reconnect wires.

## REPLACING THERMOCOUPLES

See this video: [hotkilns.com/change-thermocouple](http://hotkilns.com/change-thermocouple)

- 1) Unplug kiln or turn off the kiln at the fused disconnect switch.
- 2) Remove the Control Box and Element Terminal Box as shown in the Assembly Instructions.
- 3) Remove the Thermocouple Lead Wires.
- 4) Unscrew the Thermocouple from the kiln (these are #6 x 1-1/2" screws)
- 5) Remove Thermocouple.
- 6) Remove Thermocouple Protection Tube. Shake it and dump out the oxide powder that has accumulated inside the tube. Then reinsert the tube into the hole in the kiln.
- 7) Install a new Thermocouple and screw in place.
- 8) Replace Thermocouple Lead Wires and tighten. Be sure to get Red matched to the Minus (-) sign and the Yellow matched to the Plus (+) sign.

**Picture showing end of thermocouple.**

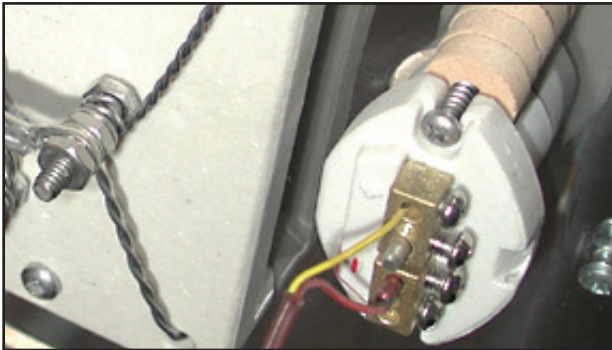

## CHECKING ELEMENT OHMS

See this video: [hotkilns.com/test-resistance-ez](http://hotkilns.com/test-resistance-ez)

See the instructions in the TROUBLESHOOTING Section of your instruction Manual (ELEMENT TROUBLESHOOTING & INSTALLATION INSTRUCTIONS) or here: [hotkilns.com/element-troubleshooting](http://hotkilns.com/element-troubleshooting)

## Element Ohm Charts

Check your wiring diagram for resistance values for your kiln. (Note - only some popular models are listed here.)

### Easy-Fire Element Ohm Chart

MODEL	VOLTS/ PHASE	ELEMENT OHMS	CIRCUIT OHMS
e18S-240	240/1	9.6	4.8
e18S-208	208/1	8.3	4.2
e18S-220	220/1 (non-US)	8.8	4.4
e18T-240	240/1	9.9	5.0
e18T-208	208/1	7.4	3.7
e18T-220	220/1 (non-US)	8.3	4.2
e18T-240-3P	240/3	9.9	5.0
e18T-208-3P	208/3	7.4	3.7
e18T-380-3P	380/3 (non-US)	8.3	4.2
e23S-240	240/1	23.5	11.8
e23S-208	208/1	20.0	10.0
e23S-220	220/1 (non-US)	21.5	10.8
e23T-240	240/1	28.9	14.5
e23T-208	208/1	25.0	12.5
e23T-220	220/1 (non-US)	26.5	13.3
e23T-240-3P	240/3	28.9	14.5
e23T-208-3P	208/3	22.7	11.4
e23T-380-3P	380/3 (non-US)	24.5	12.3
e28S-240	240/1	19.3	9.7
e28S-208	208/1	16.7	8.4
e28S-220	220/1 (non-US)	17.2	8.6
e28T-240	240/1	28.9	14.5
e28T-208	208/1	25.0	12.5
e28T-220	220/1 (non-US)	26.5	13.3
e28T-240-3P	240/3	20.0	10.0
e28T-208-3P	208/3	17.4	8.7
e28T-380-3P	380/3 (non-US)	15.1	7.6

# TROUBLESHOOTING AND REPAIR INSTRUCTIONS FOR L&L KILNS

## School-Master Top Element Ohm Chart

MODEL	VOLTS/ PHASE	ELEMENT OHMS	CIRCUIT OHMS
SM23T-240	240/1	29.3	14.7
SM23T-208	208/1	25.3	12.7
SM23T-220	220/1 (non-US)	26.8	13.4
SM23T-240-3P	240/1		
SM23T-208-3P	208/1	23.0	11.5
SM23T-380-3P	220/1 (non-US)	24.8	12.4
SM28T-240	240/1	29.3	14.7
SM28T-208	208/1	25.3	12.7
SM28T-220	220/1 (non-US)	26.8	13.4
SM28T-240-3P	240/3	20.2	10.1
SM28T-208-3P	208/3	17.6	8.8
SM28T-380-3P	380/3 (non-US)	18.8	9.4

## School-Master Bottom Element Ohm Chart

MODEL	VOLTS/ PHASE	ELEMENT OHMS	CIRCUIT OHMS
SM23T-240	240/1	28.3	14.2
SM23T-208	208/1	24.5	12.3
SM23T-220	220/1 (non-US)	25.9	13.0
SM23T-240-3P	240/1		
SM23T-208-3P	208/1	22.2	11.1
SM23T-380-3P	220/1 (non-US)	24.0	12.0
SM28T-240	240/1	28.3	14.2
SM28T-208	208/1	24.5	12.3
SM28T-220	220/1 (non-US)	25.9	13.0
SM28T-240-3P	240/3	19.6	9.8
SM28T-208-3P	208/3	17.0	8.5
SM28T-380-3P	380/3 (non-US)	18.2	9.1

## CHANGING ELEMENTS

### SEE THESE VIDEOS FIRST

For most top loading kilns:

[hotkilns.com/change-elements-ez](http://hotkilns.com/change-elements-ez)

For kilns with Quad elements:

[hotkilns.com/change-element-quad](http://hotkilns.com/change-element-quad)

See the instructions in the TROUBLESHOOTING Section of

your instruction Manual (ELEMENT TROUBLESHOOTING & INSTALLATION INSTRUCTIONS) or here: [hotkilns.com/element-troubleshooting](http://hotkilns.com/element-troubleshooting)

## REPLACING ELEMENT HOLDERS

See this video: [hotkilns.com/change-element-holder](http://hotkilns.com/change-element-holder)

1) When ordering a new holder provide model number of kiln and length of the element holder. See the Parts List for this information.

2) Note that if the holder has melted badly you may need to either replace the brick that holds it or at least patch the brick with our Brick Repair Kit.

See the extensive instructions in the TROUBLESHOOTING Section of your instruction Manual or here: [hotkilns.com/element-troubleshooting](http://hotkilns.com/element-troubleshooting)

## CRACKS IN THE LID & BOTTOM

See these videos for bad cracks:

[hotkilns.com/fix-cracks-front-load](http://hotkilns.com/fix-cracks-front-load)  
and [hotkilns.com/repair-cracked-top](http://hotkilns.com/repair-cracked-top)

See this video for hairline cracks:

[hotkilns.com/repair-hairline-cracks](http://hotkilns.com/repair-hairline-cracks)

See the instructions in the TROUBLESHOOTING Section of your instruction Manual (TROUBLESHOOTING & FIXING BRICK PROBLEMS) or here: [hotkilns.com/brick-troubleshooting](http://hotkilns.com/brick-troubleshooting)

## TIGHTENING STAINLESS BANDS

See these videos:

[hotkilns.com/replace-side-brick-kiln](http://hotkilns.com/replace-side-brick-kiln)  
[hotkilns.com/replace-side-brick-davinci](http://hotkilns.com/replace-side-brick-davinci)

See the instructions in the TROUBLESHOOTING Section of your instruction Manual (TROUBLESHOOTING & FIXING BRICK PROBLEMS) or here: [hotkilns.com/brick-troubleshooting](http://hotkilns.com/brick-troubleshooting)

## REPLACING FIREBRICK IN SIDES

See these videos:

[hotkilns.com/replace-side-brick-kiln](http://hotkilns.com/replace-side-brick-kiln)  
[hotkilns.com/replace-side-brick-davinci](http://hotkilns.com/replace-side-brick-davinci)

See the instructions in the TROUBLESHOOTING Section of your instruction Manual (TROUBLESHOOTING & FIXING BRICK PROBLEMS) or here: [hotkilns.com/brick-troubleshooting](http://hotkilns.com/brick-troubleshooting)



# TROUBLESHOOTING AND REPAIR INSTRUCTIONS FOR L&L KILNS

## DRILLING OUT HOLES FOR PEEPHOLES

---

See the instructions in the TROUBLESHOOTING Section of your instruction Manual (TROUBLESHOOTING & FIXING BRICK PROBLEMS) or here: [hotkilns.com/brick-troubleshooting](http://hotkilns.com/brick-troubleshooting)

## DRILLING OUT FOR ELEMENT CONNECTIONS

---

See the instructions in the TROUBLESHOOTING Section of your instruction Manual (TROUBLESHOOTING & FIXING BRICK PROBLEMS) or here: [hotkilns.com/brick-troubleshooting](http://hotkilns.com/brick-troubleshooting)

## REPLACING BOTTOMS

---

See the instructions in the TROUBLESHOOTING Section of your instruction Manual (TROUBLESHOOTING & FIXING BRICK PROBLEMS) or here: [hotkilns.com/brick-troubleshooting](http://hotkilns.com/brick-troubleshooting)

## REPLACING LIDS

---

See the instructions in the TROUBLESHOOTING Section of your instruction Manual (TROUBLESHOOTING & FIXING BRICK PROBLEMS) or here: [hotkilns.com/brick-troubleshooting](http://hotkilns.com/brick-troubleshooting)

## MORE ABOUT TROUBLESHOOTING CERAMIC PROBLEMS

---

1) We provide many firing tip brochures from Orton in the pdf library on our website. For a more in depth explanation Orton has a great booklet called Successful Firing Practices. They also have a number of other booklets available such as Cones and Firing (20 pages), Using Orton Cones/Temperature Charts, Kiln Safety Booklet, Kiln-Sitter Maintenance & Repair and Porcelain Firing Guide. Contact Orton at 614-895-2663 for more information. See [ortonceramic.com](http://ortonceramic.com) for lots of very helpful information on how to use cones and for many firing tips and great information on firing kilns.

2) Check out a book called Electric Kiln Ceramics written by Richard Zakin, a book called What Every Potter Should Know by Jeff Zamek and Mastering Cone 6 Glazes by Ron Roy and John Hesselberth. Check out a book called "Ceramic Faults and their remedies" by Harry Fraser, A&C Black, London.

4) The magazines Ceramics Monthly ([ceramicsmonthly.org](http://ceramicsmonthly.org)) and Clay Times ([claytimes.com](http://claytimes.com)) have many good articles and resources.

5) Also check out the great web resource, the Clayart discussion group at [potters.org](http://potters.org).

6) Check the links page on our web site.

7) Your ceramic supplier is a good source of knowledge and will have a wide variety of helpful books and videos as well

# SERVICE FOR L&L KILNS

## IN GENERAL

---

### SERVICE FOR YOUR KILN

L&L kilns are designed to be as easy to work on and fix as possible. This is one of the great advantages of L&L kilns.

### TROUBLESHOOTING GUIDE

Check out the "Support" section of our web site, [hotkilns.com](http://hotkilns.com) for all of our troubleshooting references. We are constantly adding to our troubleshooting guides and the web site has the most up-to-date information on it. Also try the search engine on our website with your question.

### THE MOST COMMON ERROR MESSAGES AND WHAT TO DO ABOUT THEM

Error 1, Err1: [hotkilns.com/e1](http://hotkilns.com/e1)

Error D, ErrD: [hotkilns.com/e-d](http://hotkilns.com/e-d)

All Error messages on the DynaTrol:  
[hotkilns.com/error-codes](http://hotkilns.com/error-codes)

Adjusting and Calibrating the DynaTrol for More Accurate Firing: [hotkilns.com/calibrating-kiln](http://hotkilns.com/calibrating-kiln)

What to do if the kiln fires slowly?: [hotkilns.com/slow-kiln](http://hotkilns.com/slow-kiln)

### YOUR LOCAL DISTRIBUTOR

Call your local distributor, most of whom service the kilns they sell. If they don't they may be able to direct you to a local kiln service person.

### OTHER KILN REPAIR PEOPLE

Search for a local kiln service person online or try your local yellow pages. L&L may also be able to recommend a local service person. We maintain a listing of kiln service people around the country. If you can't find a person experienced specifically in kiln repair, then a good electrician is often more than adequate to repair most problems that commonly occur.

### REMOVABLE CONTROL PANELS

Some of the more difficult problems occur within the control panel. One of the unique features of most L&L kilns is the easy ability to remove this panel and send it back to the factory for inspection and/or repair. Call the factory for details on your kiln.

## CUSTOMIZED TECHNICAL SUPPORT

---

To get technical support from L&L Kilns please send an email to [service@hotkilns.com](mailto:service@hotkilns.com)

Include in your email the following important information:

1. Your name.
2. Your organization name.
3. The Serial Number, Model Number and Voltage information from your Data Nameplate.
4. Your phone number and possible times to reach you during business hours.
5. A description of the problem you are having and anything you have done so far to troubleshoot it.
6. **Send Photos!**

You will get prompt, effective, and detailed expert answers. We are committed to answering service emails within one business day but normally they are answered far more quickly. If you need a phone call we can help you better if we have this information before we call.

Note about element resistance values: You can find the proper ohms for your elements on the wiring diagram which comes with your instruction manual.

## PREPARING FOR A TECHNICAL SUPPORT PHONE CALL

---

### Get Your Wiring Diagram

Be sure to get your wiring diagram if you don't have it. You can get this emailed free from our office if you know your model number, serial number and voltage. This is the key to understanding what is happening electrically and it makes a great visual reference to share with the tech support department over the phone.

### Get A Multimeter

Get a "Digital Multimeter". Digital Multi-meters are inexpensive. For around \$50 or less you can get one at a place like Amazon or Home Depot. Get one that can test at least 250 volts AC and 28 volts DC, also ohms from 0 to 200, and is able to show at least the tenths decimal place for accuracy.

### If You Need An Electrician

Sometimes you may need get an electrician or experienced person, to test live electricity if you cannot. If you get someone to provide on-site service, the kiln must be hot and exhibiting its problem when they test it. Sometimes it

# SERVICE FOR L&L KILNS

is difficult to coordinate the electrician, a hot kiln, and our technical support on the phone all at the same time, but it can be necessary to make the most of the electrician's time, and to fix the kiln in a timely fashion. It is usually best also to discuss with our technical support department the date and approximate time an electrician is expected to arrive.

## Be Aware Of Limitations

As a practical matter the technical support staff is limited by the fact that we are at a distance from your kiln, communicating by email or telephone and are often working with you through multiple sessions to fix your kiln's problem. We rely heavily on your accurate and complete description of the problem, and your responses to our questions. We rely on you to remember where we are in the process of fixing your kiln each time we talk. (Email is easier because there is a recorded thread of communication).

## Application Support

Distributors often offer a degree of application support. For instance if you are having problems with firing your work the first place to go for answers is the people who supply your clay and glazes. We offer some application support on this web site but it is minimal. Generally, this is outside the scope of our service. Look at the External Links for many great sites that can help you.

## Be Comprehensive And Proactive

We have found through long experience that is best when trouble starts to replace all of a certain part. If your elements are old and one burns out – change the whole set of elements. The same is true for thermocouples, thermocouple wires, element terminal screws, power cords, and contactors. Do not expect control panel components to reliably perform after 15 or 20 years. The heat of kilns causes unavoidable oxidation of electrical components - some that you can't see. Kilns need to be rebuilt occasionally. Changing JUST the part that is causing the immediate problem is just asking for more trouble in short order.

## WHERE TO BUY PARTS

You can order parts through your local distributor or directly from the factory. L&L stocks almost all parts we sell including elements. We normally ship within one to three days although some parts do take longer. Most parts are listed at [hotkilns.com/parts](http://hotkilns.com/parts).

**FREE LIFETIME SUPPORT IS CONTINGENT ON THE USE OF L&L FACTORY PARTS. USE OF NON-L&L PARTS WILL VOID THE WARRANTY.**

## WHAT WE CAN'T DO

We can not give you advice over the phone on hooking up your kiln to your electrical system. You must have a qualified electrician who can physically see what your specific electrical situation is and who understands any local codes.

## SELECTING AN ELECTRICAL CONTRACTOR

A quality electrical contractor:

- 1) Complies with state and local codes and regulations.
- 2) Carries the proper business and workers compensation insurance.
- 3) Is knowledgeable on a wide range of new equipment, technology and design procedures.
- 4) Has a local facility, and is willing to have you visit.
- 5) Is prompt and courteous and provides fast, reliable service -- attempting to perform service at your convenience.
- 6) Is neat and well groomed. This neatness should be reflected in their vehicles and offices as well as their personal appearance.
- 7) Provides a detailed written proposal, clearly outlining the work to be done and the agreed upon cost, including labor and materials. Make sure you understand every word of any contract before you sign it.
- 8) Asks in detail about any problems and offers understandable solutions.

## CONSIDER THE FOLLOWING

- 1) Ask for references. Find out if other customers were satisfied. Check with the local Better Business Bureau regarding any filed complaints.
- 2) Compare price. Get bids from a few contractors. Make sure you give each contractor the same specifications and materials needed for the job.
- 3) Remember! How a company treats you now reflects how they will treat you if there's a problem. A quality electrical contractor listens to your problems, understands what you want accomplished and is willing to follow up after the work is completed.

# PARTS FOR ALL KILNS (ONLINE DATABASE)

## PARTS LIST

---

A comprehensive and up-to-date listing of parts that pertain to all Kiln Series' built by L&L Kiln Mfg., Inc. can now be found on our website at,

<http://hotkilns.com/parts>

## KILN SERIES

---

Use the "Kiln Series" Parts Filter to narrow down the list of available parts to those that pertain to your specific kiln.

## CATEGORY

---

Also use the "Category" Parts Filter as well.

- Brick (Sides, Parts)
- Brick (Repair)
- Brick (Bottoms)
- Brick (Tops)
- Brick (Powered Bottoms)
- Insulation & Gaskets
- Ceramics (Element Holders)
- Ceramics (Peephole Plugs)
- Ceramics (Posts & Shelves)
- Controls (Digital)
- Controls (Thermocouples)
- Controls (Thermocouple Wire)
- Controls (Kiln Sitters)
- Controls (Manual Switches)
- Controls (Wired Panels)
- Elements
- Elements (Terminals)
- Instruction Manuals
- Kiln Sections (Powered)
- Kiln Sections (Unpowered)
- Labels
- Metal (Bell-Lift Parts)
- Metal (Control Boxes)
- Metal (Element Connect Boxes)
- Metal (Hardware)
- Metal (Hinge & Lid Parts)
- Metal (Metal Cases)
- Metal (Stands)
- Wiring (Bushings)
- Wiring (Control Wiring)
- Wiring (Fuses, Fuse Holders)
- Wiring (Wire Harnesses)
- Wiring (Cords)
- Wiring (Power Relays)
- Wiring (Power Blocks)
- Wiring (Power Wire)
- Wiring (Receptacles)
- Wiring (Switches)
- Wiring (Transformers)
- Wiring (Terminals)
- Vent System & Parts



# STANDARD LIMITED THREE YEAR WARRANTY FOR L&L KILNS

## THREE YEAR LIMITED KILN WARRANTY

L&L Kilns are warranted to be free of defects in workmanship for a period of three (3) years, starting on the date of original purchase from L&L Kiln Mfg., Inc. (L&L) or from an authorized L&L distributor or dealer, subject to the following terms and conditions, including but not limited to, the exclusions and limitations set forth herein.

- 1) A sales receipt is required for proof of purchase.
- 2) In addition, L&L may require you to deliver defective parts to L&L for examination to determine the applicability of these warranty provisions. **DO NOT DISCARD PARTS BEFORE CONTACTING L&L FOR INSTRUCTIONS. FAILURE TO ADHERE TO L&L's INSTRUCTIONS, INCLUDING THOSE CONTAINED IN THE INSTRUCTION MANUAL AND AS STATED HEREIN, WILL VOID THIS WARRANTY.**
- 3) L&L will replace or repair any defective part that is covered by this warranty and sent freight-prepaid to L&L. L&L will prepay return shipping cost without charge in the Continental United States.
- 4) On-site labor is not part of this warranty and is not covered by L&L. Any warranty labor provided by Dealers and Distributors is provided at their own discretion and expense.

## APPLICATION

Applies to Easy-Fire, Easy-Fire XT, Jupiter, DaVinci, Easy-Load, Doll/Test, JH Series, Quad-Pro kilns, Fuego and Liberty-Belle kilns when used for non-industrial ceramics and glass.

## EXCLUSIONS AND LIMITATIONS

The following are examples of items that are not covered by and/or circumstances that will void L&L's warranties:

- 1) **Use of elements and/or other parts other than genuine L&L Kiln parts.**
- 2) Kiln warranty may be voided by firing materials that introduce harmful atmospheres into the kiln. Atmospheres containing carbon, reducing atmospheres (caused, for example, by introducing carbonaceous gasses or solids like graphite or paper into the kiln), binders from lusters and decals, wax burn out effluents, fluorines, halogens, acids, metal oxides, and salts are some of the corrosive and harmful atmospheres that will damage a kiln. Most ceramic processes will release some of these harmful constituents

into the kiln and venting will prevent most of the problems that those processes would cause. Also, depending on the concentration of the harmful gasses, kiln source ventilation (such as our Vent-Sure) may limit the damage to the kiln. It is the customer's sole responsibility to ensure that the materials and the processes used are not harmful. This is of particular importance for industrial uses where processes may be unusual.

- 3) Over-firing damage for any reason and regardless of cause. **IMPORTANT: We specifically warn you not to fire the kiln unattended. Neither the Kiln Sitter, The Orton Sitter, the DynaTrol, One-Touch control, the Bartlett 3-Button control nor any other electronic control used by L&L is designed to be a failproof shut off device. L&L is not responsible for damage caused by failure of any of these controls.**

The Kiln Sitter, in particular, can be very unreliable because of the moving parts, dirt or clay that can get into the tube, the way cones are placed on the tube, corrosion, etc. **DO NOT FIRE THIS KILN UNATTENDED WHEN THE KILN IS SUPPOSED TO TURN OFF AND LEARN HOW TO USE THE TIMER BACK UP.** Neither L&L Kiln Mfg., Inc. nor Edward Orton Jr. Ceramic Foundation warranty the kiln or kiln sitter against damage caused by overfiring. We highly recommend firing all manual kilns with witness cones that you can see through the peephole and/or a pyrometer so you have some idea of what is happening inside the kiln.

Also note that it is easy to melt clay if you inadvertently fire it hotter than its rating. It is possible in some controls to limit the upper firing limit of the kiln to avoid accidental overfirings of this type. Contact factory or read your control instruction manual if you would like further information on this.

- 4) Firebrick by its nature is fragile and will chip, crack, and create dust. L&L designs its kilns to minimize the effects of this but can not warrant against cracking, breakage, spalling or dusting. There is specifically no warranty for cracked arches, tops, lids or bottoms.
- 5) Controls made by Orton (including the Orton Kiln Sitter), Eurotherm, Honeywell or other manufactures are warranted by their manufacturers. L&L is not responsible for damage caused by failure of one of these controls.
- 6) Corrosion of the case is specifically not warranted. Corrosion is typically due to use of a kiln in an unheated outside shed (where morning dew condenses on the kiln and humidity attacks the kiln) or from an unvented kiln (where the water vapor and fumes generated by firing ceramic materials attack the kiln case). However, even a vented kiln can corrode due to all the environmental and

# STANDARD LIMITED THREE YEAR WARRANTY FOR L&L KILNS

process conditions that a kiln can be exposed to. Exposure to other ambient conditions, including but not limited to humidity, rain, snow, dust, and salt air will also cause corrosion.

7) Damage due to neglect, inadequate room or kiln ventilation, mechanical abuse, improper storage, inadequate maintenance, improper use or freight damage.

8) Damage to the elements or element holders due to failure to properly keep the kiln clean (i.e. allowing glaze or ceramic chards from exploding pots) to make contact with the element holders.

9) Damage to the kiln caused for firing in ambient conditions that are too hot for the control or other components in the kiln. The DynaTrol is rated for use up to 125°F (52°C). That means that the room that you fire in should be less than 110°F (43°C) (because the control will be slightly hotter than room air due to transferred heat from the kiln). Note that direct sunlight on the control face may raise the temperature of the board beyond what you would expect from the ambient temperature or the kiln heat. Also note that the DynaTrol specifically allows the operator to check the control board temperature.

10) Failure to report defect within fifteen (15) days after it becomes manifest or known.

11) Any alteration of parts or design that vary from factory designs.

12) Thermocouple Protection Tubes are not warranted against breakage.

13) L&L's warranty is strictly limited to repair or replacement of defective items. Kilns may not be returned.

14) Distributors and Dealers are not authorized by L&L to modify and/or assume any other obligations or liabilities other than those expressed in this limited warranty and any such additional obligations are null and void.

15) EXCEPT AS SPECIFICALLY WARRANTED HEREIN, KILNS ARE SOLD AS IS. L&L MAKES NO OTHER WARRANTY, EXPRESS OR IMPLIED, COVERING THE GOODS AND SPECIFICALLY DISCLAIMS ALL IMPLIED WARRANTIES OF MERCHANTABILITY OR FITNESS FOR A PARTICULAR PURPOSE. Purchaser acknowledges that certain conditions or circumstances may be created or incurred by Purchaser or user or over which L&L has no control, including, but not limited to, climactic conditions, improper use, inadequate maintenance, and Purchaser, as a condition of purchase or use, assumes responsibility for and releases L&L from liability arising out of the use of the kilns attributable to such causes.

16) L&L SHALL NOT BE LIABLE FOR ANY INCIDENTAL, SECONDARY, OR CONSEQUENTIAL DAMAGES, INCLUDING BUT NOT LIMITED TO BODILY INJURY OR DEATH, LOST PROFITS, LOSS OF USE, OR OTHER ECONOMIC LOSSES. Purchaser agrees that L&L's total liability for any damages or remedies arising hereunder shall be limited to direct damages, in an amount not exceeding the purchase price actually paid. Replacement or repair or refund, at L&L's sole discretion, of the purchase price of the equipment purchased shall constitute the exclusive and sole remedy available to Purchaser. Any action for breach of contract or negligence must be commenced by Purchaser within one (1) year after delivery of the equipment to Purchaser.

17) L&L's full Terms and Conditions of Sale are available at [hotkilns.com/terms](http://hotkilns.com/terms).

## 3 YEAR PRO-RATED ELEMENT & THERMOCOUPLE LIMITED WARRANTY

Elements and thermocouples are warranted for three (3) years on a pro-rated basis with the following exceptions:

1) Glaze damage to the elements caused by accidentally scraping edges of unfired glazed ware against element groove. WARNING: causing unfired glaze to contaminate element will damage elements and can lead to element failure, and creates a fire hazard.

2) Firing of kiln to a temperature that exceeds the lower of either the maximum rating of kiln or 2350°F (1290°C).

3) Damage to elements caused by explosion of ceramic object. WARNING: this may cause damage to the elements and can lead to element failure, and creates a fire hazard.

**4) Elements are warranted on a prorated schedule based on the ship date of the kiln.** All dates are based on ship date from factory if sold direct or drop shipped to customer. If sold from a distributor's warehouse the date would be based on when it was shipped and/or sold from the distributor. The warranty is not extended for any period of where operation of the kiln is delayed for shipping, warehousing, or other reasons.

5) This replacement schedule is limited to new kilns. L&L does not warrant replacement elements and thermocouples except for catastrophic failure (for instance, a situation where the element end broke off without fault of the operator).

6) Labor to replace elements is not covered.

# STANDARD LIMITED THREE YEAR WARRANTY FOR L&L KILNS

7) The pro-rated discount schedule only is valid for elements that you are actually replacing. In other words you can't buy a whole set of elements at these prices for anticipated future replacement. We reserve the right to ask for replaced elements in return.

## PRO-RATED SCHEDULE FOR MOST KILNS (THAT DO HAVE A VENT-SURE INSTALLED)

Date from time of shipment from factory	Price of thermocouples and elements
0-12 Months	No Charge
12-24 Months	25% of full list price
24-36 Months	50% of full list price

## PRO-RATED SCHEDULE FOR JH SERIES KILNS AND FOR ALL KILNS THAT DO NOT HAVE A VENT-SURE INSTALLED

### JH KILNS

The pro-rated schedule for elements for the JH series kilns varies because of the hard use these kilns get during the crystalline glaze firing process.

### KILNS WITHOUT VENTS

In kilns used without an automatic Vent-Sure, the elements will corrode a lot quicker than normally and fail more quickly and this pro-rated schedule takes this into account.

Date from time of shipment from factory	Price of thermocouples and elements
0-6 Months	No Charge
6-12 Months	25% of full list price
12-24 Months	50% of full list price

## 3 YEAR LIMITED VENT WARRANTY

L&L VS-1 Vent-Sure is warranted to be free of defects in workmanship for a period of (3) years, starting from date of original purchase from L&L Kiln Mfg., Inc. or from an authorized L&L distributor or dealer. A sales receipt is required for proof of purchase. In addition, L&L may require you to send in defective parts for examination to determine the applicability of these warranty provisions. DO NOT DISCARD PARTS BEFORE CONTACTING L&L. L&L Kiln Mfg., Inc. will replace or repair any defective part sent freight-prepaid to L&L Kiln Mfg., Inc. following L&L's written acknowledgement and authorization regarding the specific issue. L&L Kiln Mfg., Inc. will prepay return shipping cost without charge in the Continental United States. On site labor is not covered by the factory; however, local distributors or dealers may offer this service.

### EXCLUSIONS & LIMITATIONS

- 1) The Vent-Sure must be used as instructed in our vent instructions.
- 2) The use of any wax process that might cause condensation of wax or other similar substance in the vent system will void the warranty.
- 3) The Vent-Sure is not warranted to vent highly corrosive fumes, and any such use will void any warranties otherwise provided.









L&L Kiln Mfg  
505 Sharptown Road  
Swedesboro, NJ 08085  
Phone: 856.294.0077  
Fax: 856.294.0070  
Email: service@hotkilns.com

MODEL NUMBER: F1418-\_\_\_\_\_

SERIAL NUMBER: \_\_\_\_\_

VOLTAGE: \_\_\_\_\_

PHASE: 1

